

CATALOGUE  
GÉNÉRAL **2020-2021**



**aric**

Le Mesnil Amelot (77)



Segré (49)



Aubervilliers (93)



# ÉDITION 2020 - 2021

Cette année, vous découvrirez près de 300 nouvelles références estampillées d'un **N**.

Nous espérons que ces produits répondront à vos attentes, et vous souhaitons de belles réalisations.

**Les tarifs HT prennent effet à partir du 1<sup>er</sup> février 2020. Ces prix sont valables en France métropolitaine et Dom-Tom.**

La technologie des lampes LED progressant rapidement, la puissance (W) est susceptible d'être inférieure à celle indiquée tout en conservant un flux lumineux (lm) équivalent ou supérieur. Nos produits peuvent être modifiés afin de les adapter aux meilleures performances disponibles.

## ARIC s'engage

La garantie 3 ans ARIC s'applique uniquement pour les lampes et les circuits LED. La garantie sur les appareils est indépendante de celle-ci.



Nous sommes certifiés  
ISO 9001 : 2015  
par Bureau Veritas.

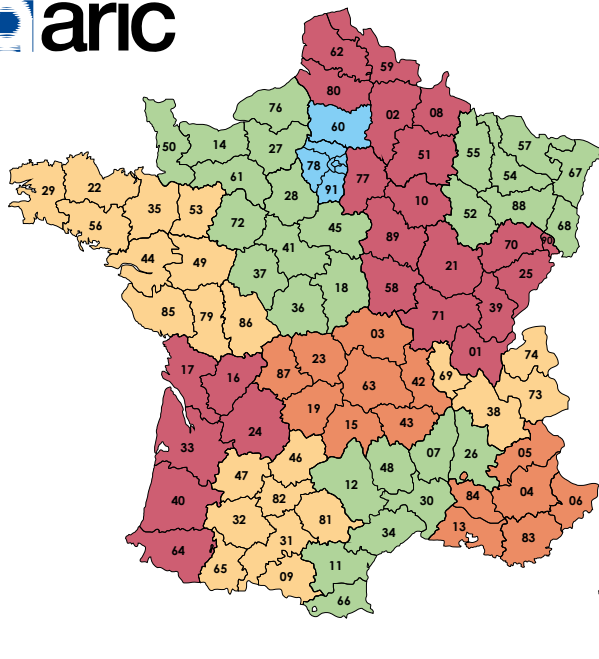

## Nous contacter

[commercial@aric-sa.fr](mailto:commercial@aric-sa.fr)  
Standard : 01 60 54 50 50

Votre secrétaire commerciale  
sédentaire :

- 01 60 54 62 68
- 01 60 54 62 65
- 01 60 54 62 78
- 01 60 54 62 67
- 01 60 54 62 79

# SOMMAIRE

|   |     |
|---|-----|
| LAMPES  | 16  |
| DALLE LED • DOWNLIGHT • ENCASTRÉ RECOUVRABLE IP65<br>ENCASTRÉ CLOISON • ENCASTRÉ MEUBLE       | 40  |
| RAILS ÉLECTRIQUES • PROJECTEUR LED MAGASIN / RAIL<br>SPOT GU10 PATÈRE / RAIL                  | 122 |
| APPLIQUE SALLE D'EAU • RÉGLETTE<br>RÉGLETTE LED MINIATURE • RÉGLETTE MEUBLE                   | 164 |
| RUBAN LED 230V • RUBAN LED 24V<br>PROFILÉ ALUMINIUM   | 192 |
| APPLIQUE MURALE INTÉRIEURE DÉCORATIVE • PLAFONNIER<br>LISEUSE • APPLIQUE TABLEAU • SUSPENSION | 228 |
| PROJECTEUR EXTÉRIEUR • ÉCLAIRAGE DE JARDIN<br>SPOT IMMERGEABLE                                | 296 |
| APPLIQUE EXTÉRIEUR • HUBLLOT<br>LANTERNE ÉCLAIRAGE EXTÉRIEUR                                  | 326 |
| BORNE • ENCASTRÉ DE SOL • EYELED<br>ENCASTRÉ DE MUR EXTÉRIEUR                                 | 358 |
| ACCESSOIRES • ALIMENTATIONS<br>PIÈCES DÉTACHÉES   | 418 |

|                                      |
|--------------------------------------|
| LAMPE                                |
| DOWNLIGHT<br>ENCASTRÉ                |
| RAIL<br>PROJECTEUR<br>SPOTERIE       |
| RÉGLETTE                             |
| RUBAN<br>PROFILÉ                     |
| APPLIQUE<br>PLAFONNIER<br>SUSPENSION |
| EXTÉRIEUR :<br>PROJECTEUR            |
| EXTÉRIEUR :<br>HUBLLOT<br>APPLIQUE   |
| EXTÉRIEUR :<br>ENCASTRÉ<br>BORNE     |
| ACCESSOIRES                          |

## S15 - LINOLITE LED 21 x 221

p. 32



## DALLE LED - BKL 600 x 600

p. 44



## DALLE LED - BKL 300 x 1200

p. 44



## START CCT 3000 K - 4000 K

p. 53



## FLAT CCT 3000 K - 4000 K

p. 54



## EF6 CCT 3000 K - 4000 K

p. 69



Collerettes en option



## AIR BLOCK 2

p. 71



## AQUAFLAT (Nouvelles couleurs)

p. 72



### AQUAPRO (Nouvelles couleurs)

p. 73



### LOKI CCT 3000 K - 4000 K

p. 75



### ASPEN CCT 3000 K - 4000 K

p. 81



### SPEED 50 IP65

p. 85



### MEUBLED IP65

p. 115



### KIT S 1200 LED

p. 116



### TEK 12, 20, 32

p. 130 à 132



Existe en :  
✓ 1 allumage  
✓ 3 allumages



### JUDY GU10 TIGE SUR RAIL

p. 142



### LORA LED

p. 185



## SIDE VIEW 120/RGB

p. 202

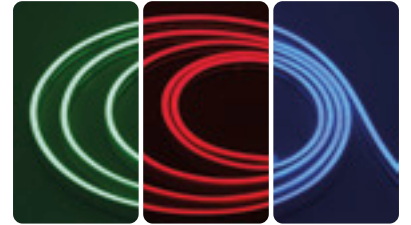

## NEON 10X10

p. 202

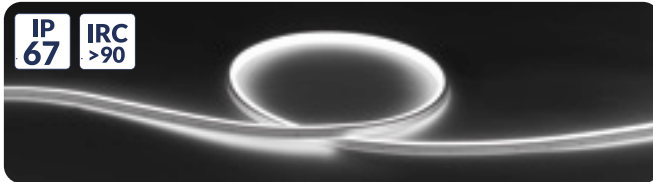

## NEON DOME

p. 203



## JAKLED 60 HR

p. 206



## PLIO 24V

p. 210

✓ Ultra-flexible



## SIDE-EMITTING 24V

p. 211



## FLEXO L4

p. 210

IRC >90



✓ Faible largeur : 4 mm

## FLEXO L5 RGB

p. 210



✓ Faible largeur : 5 mm

## FLEXO 300

p. 211

IRC >90

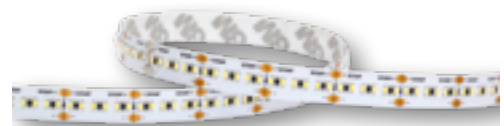

## FLEXO 60 HR

p. 216

IRC >90



## TAHITI (Nouvelle couleur)

p. 241



## STAFF

p. 251



## LIZEO

p. 257



Liseuse LED avec :  
✓ Port USB  
✓ Rétro-éclairage

## JUDY EXPO GU10

p. 262



## NINA GU10

p. 285



## HIGH BAY DIM

p. 295



**TWISTER 3**

p. 302



**SYMÉTRIQUE**



**HIGH POWER**



**ASYMÉTRIQUE**



**SENSOR**



**MICHELLE**

p. 313



✓ Détecteur PIR



**DIA**

p. 321

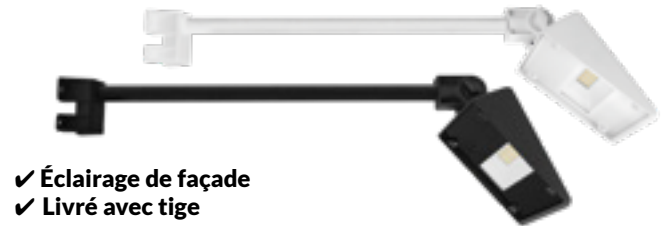

✓ Éclairage de façade  
✓ Livré avec tige

**TOPAZE GU10**

p. 322 / 340



**PROJECTEUR SUR PIQUET**



**APPLIQUE**





**RHEA CCT 3000 K - 4000 K**

p. 331



**OVALED**

p. 341



**AXO GU10**

p. 346



**TONIN E27**

p. 348



**UGOLIN**

p. 349



**PIXO**

p. 389



# LISTE DES NOMS

| Nom                   | Page      |
|-----------------------|-----------|
| <b>A</b>              |           |
| ADELA - ADELA SENSOR  | 267 / 328 |
| <b>AIR BLOCK 2</b>    | 71        |
| ALIMENTATION LED      | 427 à 431 |
| ALTON                 | 236       |
| ALVA                  | 273       |
| AMIRA                 | 255       |
| <b>AQUAFLAT</b>       | 72        |
| <b>AQUAPRO</b>        | 73        |
| AQUASOL MEDIUM        | 383       |
| AQUASOL MICRO         | 379       |
| AQUASOL MINI          | 380       |
| AQUASOL MINI LED      | 376       |
| ARGES                 | 344       |
| ARMILLA               | 273 / 335 |
| <b>ASPEN</b>          | 81        |
| ASTER                 | 324       |
| ASY LED               | 288       |
| ATON                  | 284       |
| AURA                  | 253       |
| AVERY                 | 79        |
| AXEL                  | 74        |
| AXEL CCT              | 74        |
| <b>AXO GU10</b>       | 346       |
| AXO LED               | 347       |
| <b>B</b>              |           |
| B1 - B2               | 443       |
| B20 - B30             | 443       |
| BALI                  | 413       |
| BALIZ 1               | 120       |
| BALIZ 2 - BALIZ 3     | 119       |
| BART                  | 186       |
| BELLA                 | 252       |
| BEMOL 1 - BEMOL 2     | 231       |
| BIRDY                 | 50 / 79   |
| BORA                  | 239       |
| BRASBOUL              | 414       |
| <b>C</b>              |           |
| C4                    | 266       |
| C4 REMOTE             | 265       |
| C4 SENSOR             | 264       |
| CABLED                | 191       |
| CALEO 1               | 352 / 402 |
| CALEO 2               | 403       |
| CAMILLE               | 350       |
| CANTOR                | 342       |
| CARO                  | 367       |
| CASA                  | 163       |
| CERES 2 - CERES 2 LED | 183       |
| CERO                  | 367       |
| CLASSO                | 80        |
| COLOREYE CS RGB       | 384       |

| Nom                                       | Page      |
|---|-----------|
| COMETE                                    | 150       |
| COMO                                      | 280       |
| COMO SUR RAIL                             | 292       |
| CONVERTISSEUR ÉLECTRONIQUE                | 435       |
| COOPER                                    | 281       |
| CORSO                                     | 355 / 406 |
| COSMOS                                    | 154       |
| CURVES                                    | 276       |
| CURVES SUR RAIL                           | 293       |
| <b>D</b>                                  |           |
| DAFNEE                                    | 322       |
| <b>DALLE LED - BKL</b>                    | 45        |
| <b>DALLE LED - BKL PREMIUM 300 x 1200</b> | 44        |
| <b>DALLE LED - BKL PREMIUM 600 x 600</b>  | 44        |
| DALLE LED - PREMIUM                       | 43        |
| DAO                                       | 404       |
| DE 473                                    | 422       |
| DEAUVILLE                                 | 388       |
| DEDALO                                    | 255       |
| DESIGN                                    | 181       |
| <b>DIA</b>                                | 317       |
| DIAM                                      | 149       |
| DIANA 1 - 2 - 3                           | 282       |
| DIGI 20                                   | 274       |
| DIGI 32                                   | 274       |
| DILGA                                     | 361       |
| DINA                                      | 366       |
| DINO                                      | 366       |
| DISK                                      | 105       |
| DL 084                                    | 77        |
| DL-ISO IP20                               | 67 / 90   |
| DL-ISO IP65                               | 76        |
| DLT-ISO 75                                | 66        |
| DLT-ISO 90                                | 66        |
| DOMINO                                    | 246, 248  |
| DOMINO LED                                | 251       |
| <b>E</b>                                  |           |
| ÉCARTEUR ISOLANT LED                      | 421       |
| ECCO                                      | 158       |
| ECO OVALE                                 | 340       |
| ECO ROND                                  | 340       |
| ECOLED                                    | 337       |
| EF6                                       | 68        |
| <b>EF6 CCT</b>                            | 69        |
| EF7                                       | 70        |
| EF7 CCT                                   | 70        |
| EGO                                       | 378       |
| ELASTO LED                                | 242       |
| ELFI                                      | 314 / 322 |
| ELITE                                     | 88        |
| ELITE F4 IP44                             | 78        |
| ELMA                                      | 138       |

| Nom                         | Page      |
|-----------------------------|-----------|
| ELODY - ELODY 2             | 86        |
| EN 63                       | 108       |
| ENZO B4                     | 377       |
| ÉPOQUE                      | 281       |
| EVOLI                       | 140       |
| EYDI                        | 87        |
| EYELEDS INDOOR              | 385       |
| EYELEDS OUTDOOR PRO         | 387       |
| EYELEDS OUTDOOR STANDARD    | 386       |
| <b>F</b>                    |           |
| FIDJI                       | 243       |
| FIXO                        | 104       |
| FLAT                        | 54        |
| FLAT 5W                     | 92 / 110  |
| <b>FLAT CCT</b>             | 55        |
| FLAT-ISO CCT                | 47        |
| FLEXI CRISTAL 30 - 60 - 120 | 206       |
| FLEXO 112                   | 212       |
| FLEXO 112 POWER             | 213       |
| FLEXO 120                   | 218       |
| FLEXO 120 BASSE LUMINOSITÉ  | 221       |
| FLEXO 30                    | 220       |
| <b>FLEXO 300</b>            | 211       |
| <b>FLEXO 60 HR</b>          | 216       |
| <b>FLEXO 60 HR RGB</b>      | 217       |
| FLEXO 65                    | 214       |
| FLEXO 65 RGB                | 215       |
| <b>FLEXO L4</b>             | 210       |
| <b>FLEXO L5 RGB</b>         | 210       |
| FORTISSIMO                  | 52        |
| <b>G</b>                    |           |
| GAIA                        | 268 / 329 |
| GALAXY                      | 100       |
| GEA                         | 272 / 332 |
| GEA LED DIMMABLE            | 270 / 333 |
| GILDA                       | 238       |
| GLASSDISK                   | 243       |
| GRACE                       | 51 / 78   |
| GRANT                       | 237       |
| GREEN                       | 405       |
| <b>H</b>                    |           |
| H2O                         | 173       |
| HALOLED                     | 182       |
| HALOLITE LED                | 182       |
| HARDEN                      | 48        |
| HAWAI                       | 240       |
| HIDRO                       | 82        |
| HIDRO 50 XL6                | 77        |
| HIGH BAY DIM                | 295       |
| HILL                        | 252       |
| HP 610                      | 423       |

| Nom                   | Page      |
|-----------------------|-----------|
| HUB 270 T             | 336       |
| HUB 270 TP            | 339       |
| <b>I</b>              |           |
| IDYL                  | 169       |
| IKAR                  | 126       |
| INARI                 | 363       |
| INOS - INOS M         | 232       |
| INTER SENSITIF        | 424       |
| ISO 60 - ISO 80       | 121       |
| IVARO                 | 49        |
| <b>J</b>              |           |
| JAKBEL                | 227       |
| <b>JAKLED 60 HR</b>   | 204       |
| JAKLED 65             | 202       |
| JUDY                  | 142       |
| <b>JUDY EXPO</b>      | 262       |
| JULIA                 | 277       |
| JUNIOR                | 321       |
| <b>K</b>              |           |
| KADO                  | 400       |
| KATE                  | 169       |
| KEELER                | 344 / 390 |
| KUMA                  | 255       |
| <b>L</b>              |           |
| LAGON                 | 244       |
| LAMPARO               | 357       |
| LAMPE AMBER LED       | 24        |
| LAMPE CULOTS LATÉRAUX | 35        |
| LAMPE DÉCHARGE        | 38        |
| LAMPE E14             | 22        |
| LAMPE E27 DÉTECTEUR   | 21        |
| LAMPE E27 STANDARD    | 20        |
| LAMPE G4 - G9         | 30        |
| LAMPE GLOBE           | 22        |
| LAMPE GU10            | 18        |
| LAMPE GU5,3           | 17        |
| LAMPE GX53            | 27        |
| LAMPE PAR38           | 27        |
| LAMPE R7S             | 28        |
| LAMPE RÉFLECTEUR      | 26        |
| LAMPE S14D - S14S     | 34        |
| LAMPE S15             | 32        |
| LAMPE S19             | 33        |
| LAMPE T4/T5/T8        | 36        |
| LARA                  | 250       |
| LEDIUM                | 46        |
| LEDY 230              | 197       |
| LENA                  | 353 / 410 |
| LEXA                  | 291       |
| LEXA SUR RAIL         | 294       |
| LINEAR                | 289       |
| LINELED               | 196       |

# LISTE DES NOMS

| Nom                  | Page      |
|----------------------|-----------|
| LIZA                 | 256       |
| LIZA 2               | 258       |
| LIZA 3               | 259       |
| LIZEO                | 257       |
| LIZIO                | 354       |
| LOKI                 | 75        |
| LUCIA 1              | 109       |
| LUCIA 2              | 109       |
| LUCIA XL6            | 81        |
| LUMI                 | 136       |
| LUNA                 | 353 / 411 |
| LUNAR                | 102       |
| LUNAR 35             | 108       |
| LUXMUR - LUXMUR 2    | 369       |
| LUXMUR 3             | 343       |
| LUXSOL - LUXSOL 2    | 370       |
| LYN 10 - LYN 14      | 195       |
| <b>M</b>             |           |
| MAGGIE               | 253       |
| MANTA 63             | 160       |
| MATEO                | 416       |
| MAUD                 | 166 - 167 |
| MENDY                | 134       |
| METROPOLIS LED       | 61        |
| MEUBLED 2            | 114       |
| MEUBLED IP65         | 115       |
| MF                   | 179       |
| MI 5                 | 92 / 110  |
| MI 6                 | 87 / 110  |
| MICHELLE             | 309       |
| MICRO LEM - ENCASTRÉ | 93 / 111  |
| MICRO LEM - RAIL     | 141       |
| MINI CURVES          | 277       |
| MINI SAT             | 108       |
| MIRA 45              | 374       |
| MIRA 65              | 374       |
| MODELE 300           | 364       |
| MODULED 24           | 188       |
| MONACO               | 356 / 408 |
| MOOREA               | 240       |
| MORPHIS              | 392 / 417 |
| MURA                 | 355       |
| MURENA               | 360       |
| MURO 1               | 120       |
| MURO 2               | 368       |
| MX 1000 - 1500       | 320       |
| <b>N</b>             |           |
| NEON 10X10           | 200       |
| NEON DOME            | 201       |
| NEWAY                | 395       |
| NEWAY LED            | 394       |
| NINA                 | 285       |

| Nom                                | Page      |
|------------------------------------|-----------|
| NINETY                             | 128       |
| NIZA                               | 357 / 405 |
| NOLAN                              | 146       |
| NORMARIC B52                       | 178       |
| NORMARIC B85-C                     | 176       |
| NORMARIC B85-L                     | 177       |
| NOSTALGIE                          | 278       |
| <b>O</b>                           |           |
| ONDE                               | 171       |
| ONDINE                             | 172       |
| OPERA                              | 260       |
| ORIA                               | 270 / 333 |
| ORIO                               | 337       |
| OVALE BLANC                        | 340       |
| OVALED                             | 341       |
| OVO 270 T                          | 338       |
| OVO 270 TP                         | 339       |
| OVO 330                            | 338       |
| <b>P</b>                           |           |
| P10                                | 76        |
| PALACE                             | 235       |
| PANDORA                            | 271       |
| PAO                                | 404       |
| PEARL 2                            | 111       |
| PHOBOS                             | 239       |
| PIÈCES DÉTACHÉES                   | 444       |
| PIXEL                              | 368       |
| PLATINE EVT                        | 426       |
| PLIO 24V                           | 208       |
| POLAR 312                          | 334       |
| POLO                               | 351 / 397 |
| POLO LED                           | 351 / 396 |
| POP                                | 170       |
| PROFILÉ ALU                        | 222       |
| PYXIS                              | 156       |
| <b>Q</b>                           |           |
| QUADRA 110                         | 107       |
| QUADRA à composer                  | 63        |
| QUADRA LED                         | 62        |
| <b>R</b>                           |           |
| RAIL 1 allumage 230V (modèle 029)  | 125 / 439 |
| RAIL 3 allumages 230V (modèle 023) | 124 / 441 |
| RANDY 1 - 2                        | 58        |
| RANDY 3 - 4                        | 59        |
| RANDY S                            | 58 / 90   |
| REMORA                             | 161       |
| RHEA CCT                           | 269 / 331 |
| RIVA                               | 52 / 91   |
| RL 2 - RL3                         | 442       |
| ROMA                               | 279       |
| ROSA                               | 415       |
| RUBIS                              | 148       |

| Nom                       | Page      |
|---------------------------|-----------|
| RUSSEL                    | 118       |
| RYBA                      | 163       |
| <b>S</b>                  |           |
| S 1200 LED                | 116       |
| S 307 LED                 | 116       |
| SATURNE                   | 105       |
| SAXO                      | 399       |
| SENSO LED                 | 113 / 187 |
| SENSOR 1                  | 425       |
| SENSOR PORTE              | 424       |
| SÉQUENCEUR                | 225       |
| SERENA                    | 184       |
| SIDE VIEW 120             | 198       |
| SIDE VIEW RGB             | 199       |
| SIDE-EMITTING 24V         | 209       |
| SIRIO                     | 352       |
| SLIMLED                   | 190       |
| SOCKET                    | 35        |
| SORA                      | 290       |
| SPARK                     | 112       |
| SPEED 110                 | 96        |
| SPEED 50 IP65             | 85        |
| SPEED 50                  | 94        |
| SPEED 70                  | 95        |
| SPEED 90                  | 96        |
| SPOTISOL                  | 97 / 420  |
| SQUARE                    | 106       |
| STAFF                     | 251       |
| START CCT                 | 53        |
| STELA                     | 286       |
| STICK                     | 391       |
| SUB 50                    | 325       |
| SUKO                      | 324       |
| SUNNY                     | 393       |
| SUNSET                    | 310       |
| SUNSET-E                  | 311       |
| SYRA                      | 287       |
| <b>T</b>                  |           |
| TAG                       | 316       |
| TAHITI                    | 241 / 275 |
| TAIS                      | 254       |
| TALASSO                   | 174       |
| TAYLOR                    | 234       |
| TECNISOL 150 LED          | 371       |
| TECNISOL 200 LED DIMMABLE | 372       |
| TECNISOL 200 LED DIM. ASY | 373       |
| TEK 12                    | 130       |
| TEK 20                    | 131       |
| TEK 32                    | 133       |
| TELO LED                  | 324       |
| TERMO                     | 353 / 412 |
| TESSA                     | 233 / 261 |

| Nom                       | Page      |
|---------------------------|-----------|
| TIPO                      | 98        |
| TONIN                     | 348       |
| TOP 0                     | 107       |
| TOPAZE                    | 323       |
| TORA                      | 232       |
| TORI                      | 180       |
| TOSCA LED                 | 245       |
| TOSCANE                   | 357 / 407 |
| TRANSFORMATEUR            | 434 à 437 |
| TURBO                     | 162       |
| TURKS                     | 398       |
| TWISTER 3                 | 300       |
| TWISTER 3 ASY             | 302       |
| TWISTER 3 HIGH POWER      | 305       |
| TWISTER 3 HIGH POWER ASY. | 303       |
| TWISTER 3 SENSOR          | 307       |
| <b>U</b>                  |           |
| UGO                       | 257       |
| UGOLIN                    | 349       |
| UNIVERSAL                 | 56        |
| <b>V</b>                  |           |
| VAGUE                     | 244       |
| VARIATION LED             | 432       |
| VIAX LED                  | 245       |
| VIKI                      | 250       |
| <b>W</b>                  |           |
| WALKER 1                  | 382       |
| WALKER 2                  | 382       |
| WALKER 3                  | 383       |
| WINDOW                    | 135       |
| WINK                      | 312       |
| WINK SENSOR               | 313       |
| <b>X</b>                  |           |
| XL6                       | 16        |
| <b>Y</b>                  |           |
| YEO                       | 153       |
| <b>Z</b>                  |           |
| ZAO                       | 152       |
| ZENITH                    | 321       |
| ZETA                      | 84        |
| ZINK 1                    | 254       |
| ZINK 2                    | 254       |
| ZODIAK                    | 315       |
| ZURO LED                  | 318       |

Nouveautés ■

Achevé d'imprimer en février 2020 par la société Imprimerie POLLINA - ZI de Chasnais - 85407 LUÇON CEDEX

## GLOSSAIRE DES PICTOGRAMMES



### Produit fabriqué en France.

La plupart de nos produits indiquant ce pictogramme sont également élaborés en France.



### Classe énergétique du produit

selon le règlement N°874/2012.



### Produit intégrant un circuit LED ou fourni avec une lampe LED.



L'**UGR** est une mesure définie par la CIE dans son rapport technique CIE 117-1995 qui indique le taux d'éblouissement produit par la luminosité des systèmes d'éclairage dans un environnement donné. Plus sa valeur est faible, plus l'installation est confortable. Voir norme EN12464-1.



**FLICKER FREE.** Produit dont les LED n'émettent pas de scintillement. Permet de garantir un meilleur confort visuel.

## Variation



**Produit dimmable**, pouvant fonctionner sur variateur, ce qui permet de moduler l'intensité de l'éclairage. **Plusieurs types de variation existent.**



**Produit STEP DIM**, intégrant la possibilité de varier l'intensité de la lumière par paliers, par simple pression sur interrupteur. Ne fonctionne pas sur variateur.

## Gestion couleur de la lumière



**Produit permettant de régler la température de couleur par télécommande.**



**Produit programmable** grâce à un séquenceur, permettant de régler la couleur de la lumière, autour du spectre des trois couleurs primaires (Rouge - Vert - Bleu).



**Produit permettant de sélectionner la température de couleur** de la lumière par curseur (CCT Change).

## Détection



**Produit à détection de mouvement.**



**Produit à détection de mouvement et crépusculaire.**



**Produit à détection crépusculaire.**



**Produit à détection d'ouverture/fermeture de porte.**



**Produit intégrant la fonction Veille.**

## Préconisations d'installation



**Produit permettant de répondre aux exigences de l'Arrêté du 27 décembre 2018** relatif à la prévention, à la réduction et à la limitation des nuisances lumineuses. (voir détails p. 298)



**Produit répondant aux exigences de la loi Handicap 2015** (selon l'arrêté du 8 décembre 2014).



**Produit pouvant être installé sous ou dans un meuble.** Répond aux spécificités afférentes à la protection anti-feu.



**Produit préconisé pour utilisation intérieure.**



**Produit préconisé pour utilisation extérieure.**

## Contraintes produits



**Poids maximum statique** applicable sur l'appareil.



**Température maximale de la surface** de l'appareil engendrée par la source lumineuse.



**Passage de véhicule autorisé**  
Vitesse maximale de passage.

## Personnalisation (sur commande)



**Produit pouvant être commandé à vos couleurs.** A vous de nous indiquer le RAL souhaité.

## Spécifique ruban/profilé



**Ruban pouvant être recoupé** selon section précisée.



**Produit pouvant être commandé à vos mesures.**

A vous de nous indiquer la longueur souhaitée, dans la limite des pas du produit.

# GLOSSAIRE DES PICTOGRAMMES

## Classe d'isolation électrique

Se conformer à la norme NFC 71 000.



**Classe 1** : le luminaire possède une isolation fonctionnelle avec une borne de terre, liaison équipotentielle.



**Classe 2** : le luminaire possède une isolation renforcée sans partie métallique accessible. Double isolation sans mise à la terre.



**Classe 3** : le luminaire fonctionne en très basse tension de sécurité (TBTS). Tension inférieure à 50V.

## Tension / Courant électrique



**Produit 230V direct** ou fourni avec alimentation pour raccordement direct.



**Produit 24V**, nécessite une alimentation appropriée



**Produit 12V**, nécessite une alimentation appropriée



**Produit à courant constant**, nécessite une alimentation appropriée

## Isolation bâtiment



**Produit adapté à la réglementation thermique 2012 (RT2012)**, imposant notamment une isolation du luminaire à l'air et permettant l'installation de l'appareil dans les bâtiments basse consommation (BBC).



**Produit pouvant être recouvert** de tout type d'isolant, laine de verre et isolant soufflé inclus.



**Produit pouvant être recouvert** d'isolant rouleau uniquement. N'accepte pas les isolants soufflés.



**Produit ne pouvant pas être recouvert** de matériau isolant thermique.



**Produit répondant aux critères de réaction au feu** (test au fil incandescent).

## Installation simplifiée



**Produit à raccordement facile, sans outil.** Connexion / bornier ne nécessitant pas d'outil.



**Repiquage possible.** Produit avec bornier double permettant la réalisation d'un circuit de plusieurs produits.



**Produit à collerette/anneau 1/4 de tour.**



**Produit à collerette/anneau clipsable.**



**Produit à collerette/anneau aimanté(e).**

## Indice IP selon NF EN 60598

**Degré de protection contre la pénétration des corps solides et poussières, ainsi que des liquides.**

Voir détail des indices p. 447.



Application Extérieur : IP standard.



Application Salle d'Eau : IP avec représentation de gouttes d'eau.



Cas des Projecteurs : IP différent sur face éclairante (recto) et verso.



Cas des Encastrés : IP différent sur face éclairante et partie encastrée.



Cas des Hublots : IP différent si installation au Mur (Applique) ou installation Plafond (Plafonnier).



Cas des produits immergeables : produit totalement immergeable.

## Indice IK selon NF EN 50102



**Degré de protection procuré par les enveloppes contre les chocs mécaniques externes.**

Voir détail des indices p. 447.

## Volumes pour Salles d'eau

Se conformer à la norme NFC 15-100 partie 7-701.



**Produit utilisable en Salle d'eau** selon conditions définies dans la norme. Voir détails p. 453.

## Volumes pour Piscines et Bassins

Se conformer à la norme NFC 15-100 partie 7-702.



**Produit utilisable en Piscines et Bassins** selon conditions définies dans la norme. Voir détails p. 452.

## Spécifique extérieur



**Produit résistant au Test de Brouillard Salin.** Evaluation de la résistance à la corrosion des matériaux métalliques comme décrite par la norme EN ISO 9227.



## ARIC VOUS INFORME

Le recyclage est un geste **civique, écologique** et **solidaire**.

 **aric** en tant que producteur de lampes et appareils d'éclairage, s'engage aux côtés d'**Ecosystem** pour favoriser la collecte, la dépollution et le recyclage des équipements électriques et des ampoules à économie d'énergie.



Retrouvez plus d'informations sur le site :  
[www.ecosystem.eco](http://www.ecosystem.eco)

Trouvez rapidement un point de collecte  
pour vos lampes et équipements :  
[www.ecosystem.eco/fr/recherche-point-de-collecte](http://www.ecosystem.eco/fr/recherche-point-de-collecte)

[ NOTRE NOM CHANGE,  
NOS SERVICES RESTENT ! ]



Pour recycler vos lampes :

Apport en point de collecte



Mise à disposition de bacs



Enlèvement sur chantier



**réylum**  
devient  
**ecosystem**  
recycler c'est protéger

# SOMMAIRE | LAMPE

XL6 .....p. 16



GU5,3 .....p. 17



GU10 .....p. 18



STANDARD LED .....p. 20



STANDARD DÉTECTION .....p. 21



GLOBE .....p. 22



SPHÉRIQUE .....p. 22



FLAMME .....p. 22



EDILED .....p. 23



AMBER LED .....p. 24



RÉFLECTEUR .....p. 26



PAR 38 .....p. 27



AR111 .....p. 27



GX53 .....p. 27



R7s LED .....p. 28



G4 / G9 .....p. 30



LINOLITE .....p. 32



CULOTS LATÉRAUX .....p. 34



TUBE T4 / T5 / T8 .....p. 36



LAMPE À DÉCHARGE .....p. 38



**XL6**



**635 lm**



Lampe de substitution. LED de puissance livrée avec alimentation 500mA. Permet de remplacer une lampe halogène GU10 ou GU5,3 sans remplacer le spot. Raccordement au 230V.

| P (w) | Faisceau | Lumens | Teinte   | Code         | € HT         |
|-------|----------|--------|----------|--------------|--------------|
| 6     | 40°      | 590    | ● 3000 K | <b>51071</b> | <b>43,90</b> |
| 6     | 40°      | 635    | ○ 4000 K | <b>51070</b> | <b>43,90</b> |

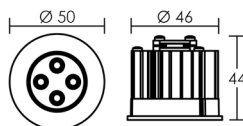

| 51071 3000K 6W 40° |                       |       |  | 51070 4000K 6W 40° |                       |       |  |
|--------------------|-----------------------|-------|--|--------------------|-----------------------|-------|--|
| h (m)              | E <sub>max</sub> (lx) | d (m) |  | h (m)              | E <sub>max</sub> (lx) | d (m) |  |
| 1                  | <b>947</b>            | 0,73  |  | 1                  | <b>1020</b>           | 0,73  |  |
| 2                  | <b>237</b>            | 1,5   |  | 2                  | <b>255</b>            | 1,5   |  |
| 2,5                | <b>152</b>            | 1,8   |  | 2,5                | <b>163</b>            | 1,8   |  |



**LAMPE XL6**

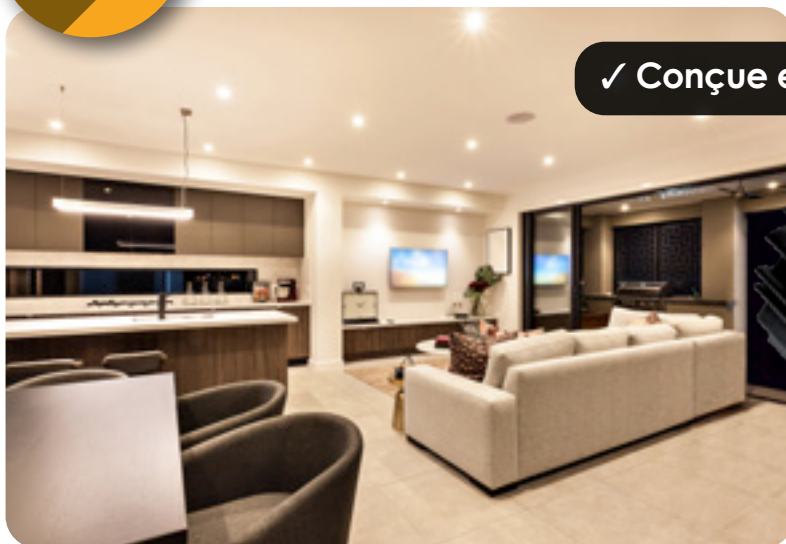

✓ **Conçue et fabriquée dans nos ateliers**



✓ **Lumière haute qualité : IRC = 83**

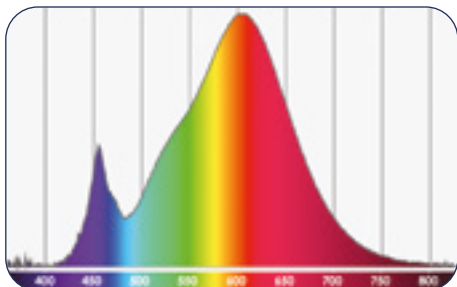

✓ **Optique semi-intensive 40°**

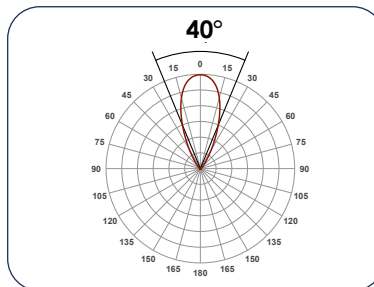

✓ **Radiateur 18 ailettes**





## GU5,3 - LED 6W



480 lm

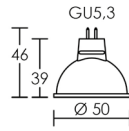

Lampe MR16. En substitution des lampes halogènes.

| P (W) | Faisceau | Lumens | Teinte | Code        | € HT        |
|-------|----------|--------|--------|-------------|-------------|
| 6     | 36°      | 460    | 3000 K | <b>2975</b> | <b>6,80</b> |
| 6     | 36°      | 480    | 4000 K | <b>2976</b> | <b>6,80</b> |

| h (m) | E <sub>max</sub> (lx) | d (m) |
|-------|-----------------------|-------|
| 1     | <b>1075</b>           | 0,65  |
| 2     | <b>269</b>            | 1,3   |
| 2,5   | <b>172</b>            | 1,6   |

| h (m) | E <sub>max</sub> (lx) | d (m) |
|-------|-----------------------|-------|
| 1     | <b>1090</b>           | 0,65  |
| 2     | <b>273</b>            | 1,3   |
| 2,5   | <b>174</b>            | 1,6   |

## GU5,3 - LED 8W

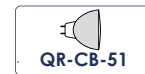

700 lm

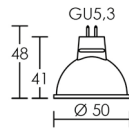

Lampe MR16. En substitution des lampes halogènes.

| P (W) | Faisceau | Lumens | Teinte | Code         | € HT        |
|-------|----------|--------|--------|--------------|-------------|
| 8     | 36°      | 680    | 2700 K | <b>20050</b> | <b>9,20</b> |
| 8     | 36°      | 700    | 4000 K | <b>20051</b> | <b>9,20</b> |

| h (m) | E <sub>max</sub> (lx) | d (m) |
|-------|-----------------------|-------|
| 1     | <b>1197</b>           | 0,65  |
| 2     | <b>299</b>            | 1,3   |
| 2,5   | <b>192</b>            | 1,6   |

| h (m) | E <sub>max</sub> (lx) | d (m) |
|-------|-----------------------|-------|
| 1     | <b>1232</b>           | 0,65  |
| 2     | <b>308</b>            | 1,3   |
| 2,5   | <b>197</b>            | 1,6   |

## GU5,3 - HALOGÈNE 50W

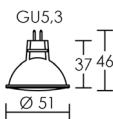

Lampe réflecteur dichroïque.

| P (W) | Culot | Faisceau | Candéla | Code        | € HT        |
|-------|-------|----------|---------|-------------|-------------|
| 50    | GU5,3 | 36°      | 1450    | <b>2777</b> | <b>2,20</b> |

Cette lampe halogène très basse tension à flux dirigé répond aux exigences d'éco-conception de l'étape 3 du règlement européen 1194/2012.

## GU10 - LED 6W



500 lm

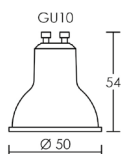

En substitution des lampes halogènes.

| P (w) | Faisceau | Lumens | Teinte | Code        | € HT        |
|-------|----------|--------|--------|-------------|-------------|
| 6     | 36°      | 470    | 3000 K | <b>2981</b> | <b>4,10</b> |
| 6     | 36°      | 500    | 4000 K | <b>2982</b> | <b>4,10</b> |

| LED 6E | 3000K | 6W                    | 36°   |
|--------|-------|-----------------------|-------|
|        | h (m) | E <sub>max</sub> (lx) | d (m) |
|        | 1     | <b>972</b>            | 0,65  |
|        | 2     | <b>243</b>            | 1,3   |
|        | 2,5   | <b>156</b>            | 1,6   |

| LED 6E | 4000K | 6W                    | 36°   |
|--------|-------|-----------------------|-------|
|        | h (m) | E <sub>max</sub> (lx) | d (m) |
|        | 1     | <b>1035</b>           | 0,65  |
|        | 2     | <b>259</b>            | 1,3   |
|        | 2,5   | <b>166</b>            | 1,6   |

## GU10 - LED 7W



670 lm

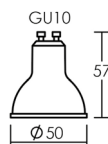

En substitution des lampes halogènes.

| P (w) | Faisceau | Lumens | Teinte | Code        | € HT        |
|-------|----------|--------|--------|-------------|-------------|
| 7     | 36°      | 650    | 3000 K | <b>2997</b> | <b>6,10</b> |
| 7     | 36°      | 670    | 4000 K | <b>2998</b> | <b>6,10</b> |

| 2997 | 3000K | 7 W                   | 36°   |
|------|-------|-----------------------|-------|
|      | h (m) | E <sub>max</sub> (lx) | d (m) |
|      | 1     | <b>1295</b>           | 0,65  |
|      | 2     | <b>324</b>            | 1,3   |
|      | 2,5   | <b>207</b>            | 1,6   |

| 2998 | 4000K | 7 W                   | 36°   |
|------|-------|-----------------------|-------|
|      | h (m) | E <sub>max</sub> (lx) | d (m) |
|      | 1     | <b>1335</b>           | 0,65  |
|      | 2     | <b>334</b>            | 1,3   |
|      | 2,5   | <b>214</b>            | 1,6   |

## GU10 - LED 6W - Basse luminance



480 lm

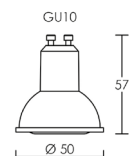

Faisceau 50°. En substitution des lampes halogènes.

| P (w) | Lumens | Teinte | Couleur | Code        | € HT         |
|-------|--------|--------|---------|-------------|--------------|
| 6     | 460    | 2700 K | blanc   | <b>2948</b> | <b>10,50</b> |
| 6     | 480    | 4000 K | blanc   | <b>2949</b> | <b>10,50</b> |
| 6     | 460    | 2700 K | gris    | <b>2954</b> | <b>10,50</b> |
| 6     | 480    | 4000 K | gris    | <b>2955</b> | <b>10,50</b> |

| LED 6 | 2700 K | 6 W                   | 50°   |
|-------|--------|-----------------------|-------|
|       | h (m)  | E <sub>max</sub> (lx) | d (m) |
|       | 1      | <b>620</b>            | 0,93  |
|       | 2      | <b>155</b>            | 1,9   |
|       | 2,5    | <b>99</b>             | 2,3   |

| LED 6 | 4000 K | 6 W                   | 50°   |
|-------|--------|-----------------------|-------|
|       | h (m)  | E <sub>max</sub> (lx) | d (m) |
|       | 1      | <b>632</b>            | 0,93  |
|       | 2      | <b>158</b>            | 1,9   |
|       | 2,5    | <b>101</b>            | 2,3   |

## GU10 - LED 4,5W STEP DIM



230V

390 lm

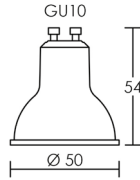

En substitution des lampes halogènes.

**Ne pas utiliser sur variateur : variation par interrupteur.**

1<sup>er</sup> on/off = 100% ; 2<sup>d</sup> on/off (< 8 sec.) = 45% ;

3<sup>ème</sup> on/off (< 8 sec.) = 15% ; 4<sup>ème</sup> on/off = 100%.

Si on éteint plus de **20 sec.** = retour à 100%.

| P (W) | Faisceau | Lumens | Teinte   | Code         | € HT        |
|-------|----------|--------|----------|--------------|-------------|
| 4,5   | 40°      | 390    | ● 2700 K | <b>20030</b> | <b>6,10</b> |
| 4,5   | 40°      | 390    | ○ 4000 K | <b>20031</b> | <b>6,10</b> |

| 20030 | 2700K                 | 4,5W  | 40° |
|-------|-----------------------|-------|-----|
| h (m) | E <sub>max</sub> (lx) | d (m) |     |
| 1     | <b>700</b>            | 0,73  |     |
| 2     | <b>175</b>            | 1,5   |     |
| 2,5   | <b>112</b>            | 1,8   |     |

| 20031 | 4000K                 | 4,5W  | 40° |
|-------|-----------------------|-------|-----|
| h (m) | E <sub>max</sub> (lx) | d (m) |     |
| 1     | <b>700</b>            | 0,73  |     |
| 2     | <b>175</b>            | 1,5   |     |
| 2,5   | <b>112</b>            | 1,8   |     |

## GU10 - GLASS LED DIMMABLE 5,5W



230V

410 lm

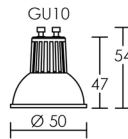

Dimensions et rendu lumineux comparables à la version halogène.

| P (W) | Faisceau | Lumens | Teinte   | Code        | € HT        |
|-------|----------|--------|----------|-------------|-------------|
| 5,5   | 36°      | 410    | ● 3000 K | <b>2993</b> | <b>8,20</b> |
| 5,5   | 36°      | 410    | ○ 4000 K | <b>2994</b> | <b>8,20</b> |

Dimmable par coupure de fin de phase.

| GLASS | 3000K                 | 5,5 W | 36° |
|-------|-----------------------|-------|-----|
| h (m) | E <sub>max</sub> (lx) | d (m) |     |
| 1     | <b>692</b>            | 0,65  |     |
| 2     | <b>173</b>            | 1,3   |     |
| 2,5   | <b>111</b>            | 1,6   |     |

| GLASS | 4000K                 | 5,5 W | 36° |
|-------|-----------------------|-------|-----|
| h (m) | E <sub>max</sub> (lx) | d (m) |     |
| 1     | <b>692</b>            | 0,65  |     |
| 2     | <b>173</b>            | 1,3   |     |
| 2,5   | <b>111</b>            | 1,6   |     |

## GU10 - GLASS LED 6W



230V

500 lm

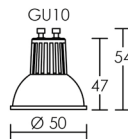

Dimensions et rendu lumineux comparables à la version halogène.

| P (W) | Faisceau | Lumens | Teinte   | Code        | € HT        |
|-------|----------|--------|----------|-------------|-------------|
| 6     | 36°      | 500    | ● 3000 K | <b>2890</b> | <b>6,90</b> |
| 6     | 36°      | 500    | ○ 4000 K | <b>2897</b> | <b>6,90</b> |

| GLASS | 3000K                 | 6W    | 36° |
|-------|-----------------------|-------|-----|
| h (m) | E <sub>max</sub> (lx) | d (m) |     |
| 1     | <b>888</b>            | 0,65  |     |
| 2     | <b>222</b>            | 1,3   |     |
| 3     | <b>99</b>             | 1,9   |     |

| GLASS | 4000K                 | 6W    | 36° |
|-------|-----------------------|-------|-----|
| h (m) | E <sub>max</sub> (lx) | d (m) |     |
| 1     | <b>888</b>            | 0,65  |     |
| 2     | <b>222</b>            | 1,3   |     |
| 3     | <b>99</b>             | 1,9   |     |

## STANDARD - LED



Jusqu'à  
**820 lm**

### Version STEP DIM

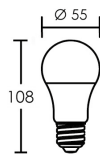

E27  
**2940**  
**20032**  
**20033**

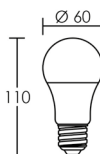

E27  
**2956**  
**20014**

Ne pas utiliser sur variateur : variation par interrupteur.

1<sup>er</sup> on/off = 100% ; 2<sup>d</sup> on/off (< 8 sec.) = 45% ;  
3<sup>ème</sup> on/off (< 8 sec.) = 15% ; 4<sup>ème</sup> on/off = 100%.  
Si on éteint plus de **20 sec.** = retour à 100%.

| P (W) | Culot | Lumens | Teinte   | Code         | € HT        |
|-------|-------|--------|----------|--------------|-------------|
| 8,5   | E27   | 806    | ● 2700 K | <b>20032</b> | <b>7,10</b> |
| 8,5   | E27   | 806    | ○ 4000 K | <b>20033</b> | <b>7,10</b> |

### Version standard

| P (W) | Culot | Lumens | Teinte   | Code         | € HT        |
|-------|-------|--------|----------|--------------|-------------|
| 6     | E27   | 470    | ● 2700 K | <b>2940*</b> | <b>5,10</b> |
| 9     | E27   | 806    | ● 2700 K | <b>2956</b>  | <b>6,10</b> |
| 9     | E27   | 820    | ○ 4000 K | <b>20014</b> | <b>6,10</b> |

## STANDARD - LED 12W DIMMABLE



**1100 lm**



| P (W) | Culot | Lumens | Teinte   | Code        | € HT         |
|-------|-------|--------|----------|-------------|--------------|
| 12    | E27   | 1100   | ● 2700 K | <b>2960</b> | <b>15,30</b> |

Dimmable par coupure de phase.

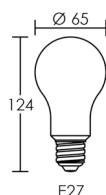

E27

## STANDARD - LED FORTE PUISSANCE



**2450 lm**



| P (W) | Culot | Lumens | Teinte   | Code          | € HT         |
|-------|-------|--------|----------|---------------|--------------|
| 15    | E27   | 1920   | ○ 4000 K | <b>20010*</b> | <b>15,30</b> |
| 20    | E27   | 2450   | ○ 4000 K | <b>20011</b>  | <b>17,30</b> |

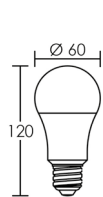

E27

**20010**

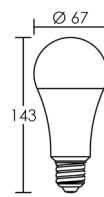

E27

**20011**

## STANDARD - LED à détecteur crépusculaire / mouvement intégré



806 lm

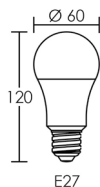

Le détecteur crépusculaire intégré permet à la lampe de s'allumer ou de s'éteindre automatiquement en fonction de la luminosité. Le détecteur de mouvement intégré permet à la lampe de s'allumer uniquement en votre présence.

| P (W) | Culot | Lumens | Teinte | Code  | € HT  |
|-------|-------|--------|--------|-------|-------|
| 9     | E27   | 806    | 2700 K | 20012 | 24,50 |

### FONCTIONNEMENT DU DÉTECTEUR DE MOUVEMENT

❶ Pièce inoccupée de nuit

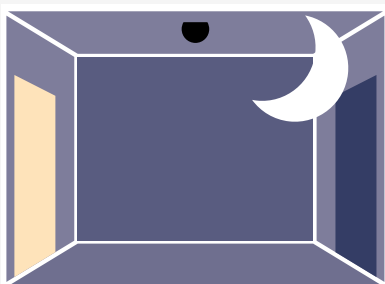

❷ Détection à 8 m sur 180°

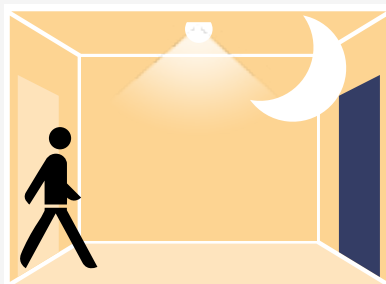

❸ 20 secondes avant extinction

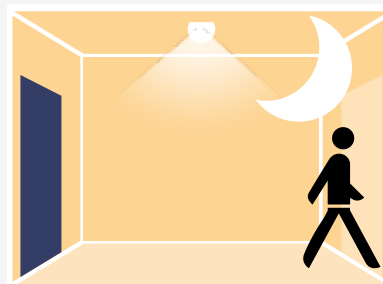

## STANDARD - LED à détecteur crépusculaire intégré



806 lm

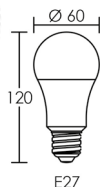

Le détecteur crépusculaire intégré permet à la lampe de s'allumer ou de s'éteindre automatiquement en fonction de la luminosité.

| P (W) | Culot | Lumens | Teinte | Code  | € HT  |
|-------|-------|--------|--------|-------|-------|
| 9,5   | E27   | 806    | 2700 K | 20013 | 11,20 |

### FONCTIONNEMENT DU DÉTECTEUR CRÉPUSCULAIRE

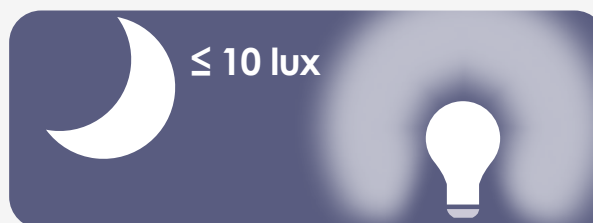

## GLOBE - LED 12W



230V

1050 lm



| P (w) | Culot | Lumens | Teinte   | Code        | € HT         |
|-------|-------|--------|----------|-------------|--------------|
| 12    | E27   | 1050   | ☉ 2700 K | <b>2958</b> | <b>18,40</b> |

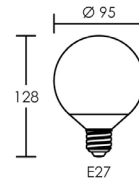

## E27 - SPHÉRIQUE LED



230V

470 lm



| P (w) | Culot | Lumens | Teinte   | Code        | € HT        |
|-------|-------|--------|----------|-------------|-------------|
| 6     | E27   | 470    | ☉ 2700 K | <b>2939</b> | <b>5,10</b> |

830 lm

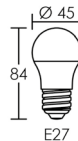

| P (w) | Culot | Lumens | Teinte   | Code         | € HT        |
|-------|-------|--------|----------|--------------|-------------|
| 7,5   | E27   | 830    | ☉ 4000 K | <b>20015</b> | <b>6,50</b> |

## E14 - FLAMME LED



230V

470 lm

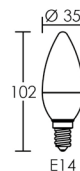

| P (w) | Culot | Lumens | Teinte   | Code        | € HT        |
|-------|-------|--------|----------|-------------|-------------|
| 5,4   | E14   | 470    | ☉ 2700 K | <b>2991</b> | <b>5,90</b> |

## E14 - SPHÉRIQUE LED 5W STEP DIM



470 lm

**Ne pas utiliser sur variateur : variation par interrupteur.****1<sup>er</sup> on/off = 100% ; 2<sup>d</sup> on/off (< 8 sec.) = 45% ;****3<sup>ème</sup> on/off (< 8 sec.) = 15% ; 4<sup>ème</sup> on/off = 100%.****Si on éteint plus de 20 sec. = retour à 100%.**

| P (w) | Culot | Lumens | Teinte   | Code         | € HT        |
|-------|-------|--------|----------|--------------|-------------|
| 5     | E14   | 470    | ● 2700 K | <b>20034</b> | <b>6,10</b> |
| 5     | E14   | 470    | ○ 4000 K | <b>20035</b> | <b>6,10</b> |

## E14 - SPHÉRIQUE LED 6W



470 lm



| P (w) | Culot | Lumens | Teinte   | Code        | € HT        |
|-------|-------|--------|----------|-------------|-------------|
| 6     | E14   | 470    | ● 2700 K | <b>2938</b> | <b>5,10</b> |

## E14 - SPHÉRIQUE EDILED



450 lm



Lampe sphérique E14 au design traditionnel, dimensions identiques aux lampes sphériques classiques. Lumière chaude équivalente aux versions incandescentes.

| P (w) | Culot | Lumens | Teinte   | Code        | € HT        |
|-------|-------|--------|----------|-------------|-------------|
| 4     | E14   | 450    | ● 2700 K | <b>2894</b> | <b>7,10</b> |

## STANDARD - AMBER LED 3,5W

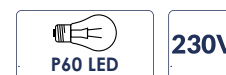

130 lm

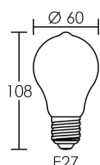

Lampe standard E27 au design traditionnel, style rétro. Verre finition ambrée. Lumière chaude reproduisant les anciennes lampes à filament.

| P (w) | Culot | Lumens | Teinte   | Code         | € HT         |
|-------|-------|--------|----------|--------------|--------------|
| 3,5   | E27   | 130    | ☉ 2200 K | <b>20022</b> | <b>20,40</b> |

Dimmable par coupure de fin de phase.

## STANDARD - AMBER LED 4W



150 lm

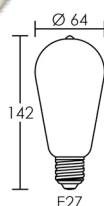
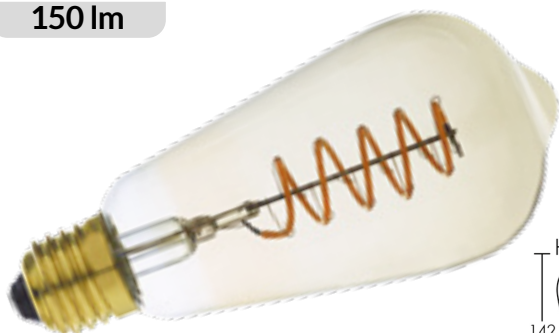

Lampe standard E27 au design traditionnel, style rétro. Verre finition ambrée. Lumière chaude reproduisant les anciennes lampes à filament.

| P (w) | Culot | Lumens | Teinte   | Code         | € HT         |
|-------|-------|--------|----------|--------------|--------------|
| 4     | E27   | 150    | ☉ 2200 K | <b>20020</b> | <b>23,20</b> |

Dimmable par coupure de fin de phase.

## FLAMME - AMBER LED 2,5W



75 lm

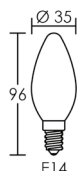
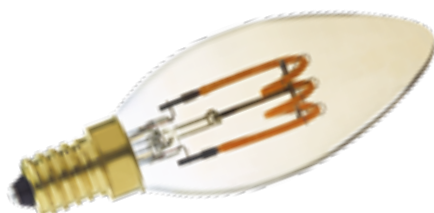

Lampe flamme E14 au design traditionnel, style rétro. Verre finition ambrée. Lumière chaude reproduisant les anciennes lampes à filament.

| P (w) | Culot | Lumens | Teinte   | Code         | € HT         |
|-------|-------|--------|----------|--------------|--------------|
| 2,5   | E14   | 75     | ☉ 2200 K | <b>20023</b> | <b>15,70</b> |

Dimmable par coupure de fin de phase.



# GLOBE - AMBER LED 3,5W



130 lm

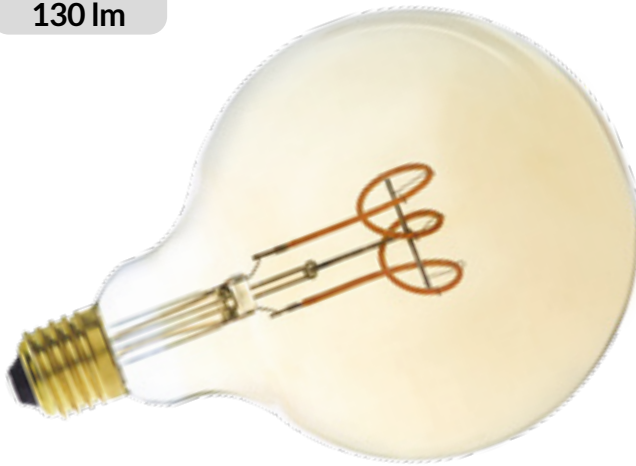

Lampe globe E27 au design traditionnel, style rétro. Verre finition ambrée. Lumière chaude reproduisant les anciennes lampes à filament.

| P (W) | Culot | Lumens | Teinte   | Code         | € HT         |
|-------|-------|--------|----------|--------------|--------------|
| 3,5   | E27   | 130    | ☉ 2200 K | <b>20021</b> | <b>25,00</b> |

Dimmable par coupure de fin de phase.

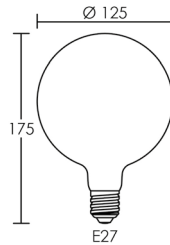

## Appareils adaptés à ces lampes :

### ROMA

> lampe E27

Code : 4204 - 4205  
p. 279



### SUSPENSION ÉPOQUE

> lampe E27

Code : 50449 - 50450  
p. 281



## R50 - RÉFLECTEUR LED 5W



350 lm

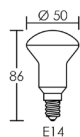

| P (w) | Culot | Lumens | Teinte   | Code        | € HT         |
|-------|-------|--------|----------|-------------|--------------|
| 5     | E14   | 350    | ☉ 2700 K | <b>2979</b> | <b>11,20</b> |

## R63 - RÉFLECTEUR LED



850 lm

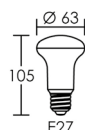

| P (w) | Culot | Lumens | Teinte   | Code        | € HT         |
|-------|-------|--------|----------|-------------|--------------|
| 6     | E27   | 600    | ☉ 2700 K | <b>2987</b> | <b>13,30</b> |
| 9     | E27   | 850    | ☉ 2700 K | <b>2964</b> | <b>15,30</b> |

## R80 - RÉFLECTEUR LED



900 lm

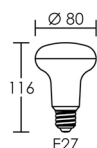

| P (w) | Culot | Lumens | Teinte   | Code        | € HT         |
|-------|-------|--------|----------|-------------|--------------|
| 8     | E27   | 730    | ☉ 2700 K | <b>2988</b> | <b>17,30</b> |
| 10    | E27   | 900    | ☉ 2700 K | <b>2963</b> | <b>22,40</b> |

| 2963  | 2700K                 | 10W   | 120° |
|-------|-----------------------|-------|------|
| h (m) | E <sub>max</sub> (lx) | d (m) |      |
| 1     | <b>249</b>            | 3,46  |      |
| 2     | <b>62</b>             | 6,9   |      |
| 2,5   | <b>40</b>             | 8,7   |      |

## PAR 38 - RÉFLECTEUR LED 15W



1350 lm



Culot E27.

| P (W) | Faisceau | Lumens | Teinte   | Code        | € HT         |
|-------|----------|--------|----------|-------------|--------------|
| 15    | 30°      | 1350   | ○ 4000 K | <b>2980</b> | <b>43,90</b> |
| 15    | 30°      | 1350   | ● 3000 K | <b>2995</b> | <b>43,90</b> |

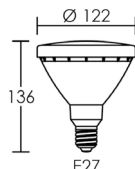

| PAR 38 LED | 4000 K                      | 15 W  | 30° |
|------------|-----------------------------|-------|-----|
| h (m)      | <b>E<sub>max</sub> (lx)</b> | d (m) |     |
| 1          | <b>2172</b>                 | 0,54  |     |
| 2          | <b>543</b>                  | 1,1   |     |
| 3          | <b>241</b>                  | 1,6   |     |
| 4          | <b>136</b>                  | 2,1   |     |
| 5          | <b>87</b>                   | 2,7   |     |

| PAR 38 LED | 3000 K                      | 15 W  | 30° |
|------------|-----------------------------|-------|-----|
| h (m)      | <b>E<sub>max</sub> (lx)</b> | d (m) |     |
| 1          | <b>2172</b>                 | 0,54  |     |
| 2          | <b>543</b>                  | 1,1   |     |
| 3          | <b>241</b>                  | 1,6   |     |
| 4          | <b>136</b>                  | 2,1   |     |
| 5          | <b>87</b>                   | 2,7   |     |

## AR111 - RÉFLECTEUR LED 12W

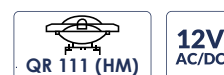

950 lm



Culot G53. En substitution des lampes halogènes.

| P (W) | Faisceau | Lumens | Teinte   | Code        | € HT         |
|-------|----------|--------|----------|-------------|--------------|
| 12    | 30°      | 950    | ● 3000 K | <b>2959</b> | <b>44,90</b> |

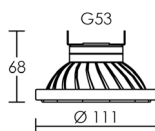

| 2959  | 3000 K                      | 12W   | 30° |
|-------|-----------------------------|-------|-----|
| h (m) | <b>E<sub>max</sub> (lx)</b> | d (m) |     |
| 1     | <b>1582</b>                 | 0,54  |     |
| 2     | <b>396</b>                  | 1,07  |     |
| 2,5   | <b>253</b>                  | 1,34  |     |

## GX53 - LED 7W

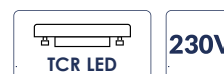

700 lm



Lampe plate MULTILED. Culot GX53.

| P (W) | Faisceau | Lumens | Teinte   | Code        | € HT         |
|-------|----------|--------|----------|-------------|--------------|
| 7     | 110°     | 550    | ● 2700 K | <b>2942</b> | <b>27,20</b> |
| 7     | 110°     | 700    | ○ 4000 K | <b>2992</b> | <b>27,20</b> |

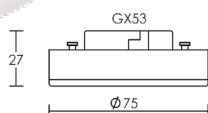

| GX53  | 2700K                       | 7W    | 110° |
|-------|-----------------------------|-------|------|
| h (m) | <b>E<sub>max</sub> (lx)</b> | d (m) |      |
| 1     | <b>203</b>                  | 2,86  |      |
| 2     | <b>51</b>                   | 5,7   |      |
| 2,5   | <b>33</b>                   | 7,1   |      |

| GX53  | 4000K                       | 7W    | 110° |
|-------|-----------------------------|-------|------|
| h (m) | <b>E<sub>max</sub> (lx)</b> | d (m) |      |
| 1     | <b>259</b>                  | 2,86  |      |
| 2     | <b>65</b>                   | 5,7   |      |
| 2,5   | <b>41</b>                   | 7,1   |      |

## R7s 118 mm - Flux dirigé LED 12W

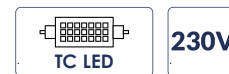

1200 lm

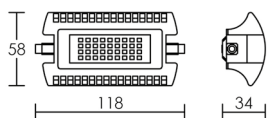

En remplacement des R7s halogènes.

| P (W) | Faisceau | Lumens | Teinte   | Code        | € HT         |
|-------|----------|--------|----------|-------------|--------------|
| 12    | 110°     | 1200   | ○ 4000 K | <b>2951</b> | <b>28,60</b> |

## R7s HALOGÈNE ÉCO

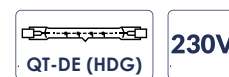

Lampe crayon. Culot R7s.

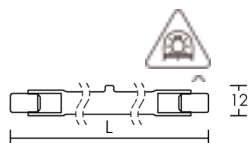

| P (W) | L (mm) | Lumens | Teinte   | Code        | € HT        |
|-------|--------|--------|----------|-------------|-------------|
| 80    | 78     | 1415   | ○ 2900 K | <b>2708</b> | <b>5,60</b> |
| 80    | 118    | 1375   | ○ 2800 K | <b>2818</b> | <b>5,80</b> |
| 120   | 118    | 2220   | ○ 2900 K | <b>2765</b> | <b>5,80</b> |
| 160   | 118    | 3100   | ○ 2900 K | <b>2766</b> | <b>6,30</b> |
| 240   | 118    | 4900   | ○ 2900 K | <b>2773</b> | <b>6,30</b> |
| 400   | 118    | 8600   | ○ 2900 K | <b>2778</b> | <b>7,50</b> |

## R7s 78 mm - 360° LED 6W

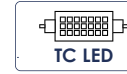

230V

700 lm

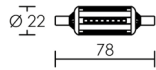

Culot et enveloppe polycarbonate. Radiateur interne en aluminium.

| P (W)      | Faisceau | Lumens | Teinte   | Code         | € HT         |
|------------|----------|--------|----------|--------------|--------------|
| <b>N</b> 6 | 360°     | 650    | ● 3000 K | <b>20019</b> | <b>16,00</b> |
| 6          | 360°     | 700    | ○ 4000 K | <b>2928</b>  | <b>16,30</b> |

## R7s 118 mm - 360° LED 10W

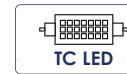

230V

1250 lm

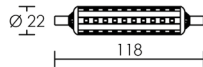

Culot et enveloppe polycarbonate. Radiateur interne en aluminium.

| P (W) | Faisceau | Lumens | Teinte   | Code        | € HT         |
|-------|----------|--------|----------|-------------|--------------|
| 10    | 360°     | 1150   | ● 3000 K | <b>2929</b> | <b>22,40</b> |
| 10    | 360°     | 1250   | ○ 4000 K | <b>2972</b> | <b>22,40</b> |

## R7s 118 mm - 360° LED 10W DIMMABLE

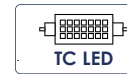

230V

1050 lm

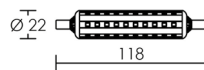

Culot et enveloppe polycarbonate. Radiateur interne en aluminium.

| P (W) | Faisceau | Lumens | Teinte   | Code         | € HT         |
|-------|----------|--------|----------|--------------|--------------|
| 10    | 360°     | 1000   | ● 3000 K | <b>20016</b> | <b>27,50</b> |
| 10    | 360°     | 1050   | ○ 4000 K | <b>20017</b> | <b>27,50</b> |

Dimmable par coupure de phase.

## Appareils adaptés à ces lampes :

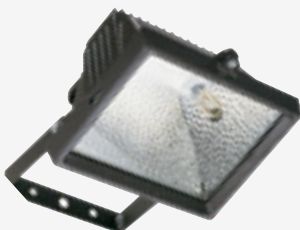

## ZENITH

Code : 0563  
p. 321

## JUNIOR

Code : 0574  
p. 321

## G9 - LED 2,4W



200 lm

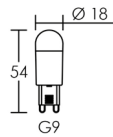

Lampe encapsulée G9. LED 15000 h.

| P (w) | Culot | Lumens | Teinte   | Code | € HT |
|-------|-------|--------|----------|------|------|
| 2,4   | G9    | 200    | ● 2700 K | 2551 | 8,10 |

## G9 - LED 2,4W



360 lm

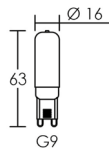

Lampe encapsulée G9.

| P (w) | Culot | Lumens | Teinte   | Code | € HT  |
|-------|-------|--------|----------|------|-------|
| 3,8   | G9    | 360    | ● 3000 K | 2554 | 22,00 |

## G4 - LED 2,4W



180 lm

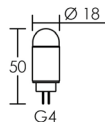

Lampe encapsulée G4.

| P (w) | Culot | Lumens | Teinte   | Code | € HT  |
|-------|-------|--------|----------|------|-------|
| 2,4   | G4    | 180    | ● 2700 K | 2576 | 10,50 |

## G4 - LED 1,8W



150 lm

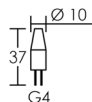

Lampe encapsulée G4.

| P (w) | Culot | Lumens | Teinte   | Code | € HT |
|-------|-------|--------|----------|------|------|
| 1,8   | G4    | 150    | ● 3000 K | 2877 | 9,30 |

## G4 - LED 1W

12V  
AC/DC

130 lm

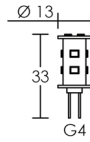
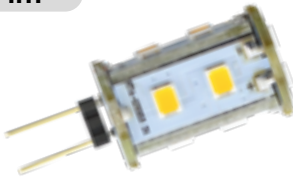

Lampe G4 circuit apparent.

| P (w) | Culot | Lumens | Teinte   | Code        | € HT         |
|-------|-------|--------|----------|-------------|--------------|
| 1     | G4    | 130    | ● 3000 K | <b>2566</b> | <b>13,70</b> |
| 1     | G4    | 130    | ○ 4000 K | <b>2567</b> | <b>13,70</b> |

## G4 - LED 1W

12V  
AC/DC

110 lm

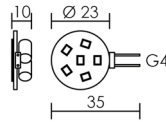

Lampe G4 circuit apparent.

| P (w) | Culot | Lumens | Teinte   | Code        | € HT         |
|-------|-------|--------|----------|-------------|--------------|
| 1     | G4    | 110    | ● 3000 K | <b>2585</b> | <b>14,30</b> |
| 1     | G4    | 110    | ○ 4000 K | <b>2586</b> | <b>14,30</b> |

## G4 - LED 2W

12V  
AC/DC

130 lm

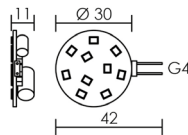
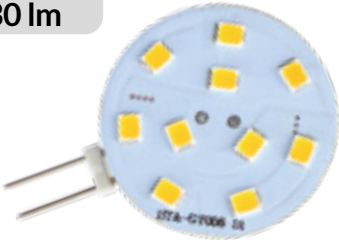

Lampe G4 circuit apparent.

| P (w) | Culot | Lumens | Teinte   | Code        | € HT         |
|-------|-------|--------|----------|-------------|--------------|
| 2     | G4    | 220    | ● 3000 K | <b>2569</b> | <b>20,50</b> |
| 2     | G4    | 220    | ○ 4000 K | <b>2582</b> | <b>20,50</b> |

## G4 - LED 3W

12V  
AC/DC

280 lm

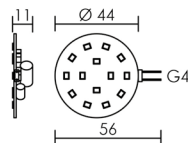

Lampe G4 circuit apparent.

| P (w) | Culot | Lumens | Teinte   | Code        | € HT         |
|-------|-------|--------|----------|-------------|--------------|
| 3     | G4    | 280    | ● 3000 K | <b>2583</b> | <b>23,90</b> |

- Non compatible avec tous les transformateurs **électroniques** pour lampes **halogènes**.
- Faire un essai avant remplacement total.
- Utiliser un transformateur pour lampe LED AC/DC.
- Compatible transformateur ferromagnétique.

## S15 - LINOLITE LED 21 x 221 - 3,5W



250 lm

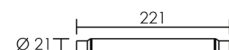

Lampe LINOLITE S15 opale. Remplace les lampes incandescentes.

| P (W)        | Dim. Ø x L (mm) | Lumens | Teinte   | Code         | € HT         |
|--------------|-----------------|--------|----------|--------------|--------------|
| <b>N</b> 3,5 | 21 x 221        | 250    | ☉ 2700 K | <b>20018</b> | <b>14,00</b> |

## S15 - LINOLITE LED 25 x 221 - 3,5W



385 lm



Lampe LINOLITE S15 opale. Remplace les lampes incandescentes.

| P (W) | Dim. Ø x L (mm) | Lumens | Teinte   | Code        | € HT         |
|-------|-----------------|--------|----------|-------------|--------------|
| 3,5   | 25 x 221        | 385    | ☉ 2700 K | <b>2946</b> | <b>15,30</b> |



## LINOLITE LED



✓ 100% équivalente à l'incandescente

✓ 4W - 400 lm - 2700 K  
7W - 600 lm - 2700 K  
7W - 700 lm - 4000 K

✓ Flux dirigé > 60W incan.



✓ Fait l'objet d'un brevet français N° 15/52375

✓ Conçue et fabriquée dans nos ateliers





## S19 - LINOLITE LED 38 x 310 - 4W

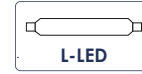

230V

400 lm

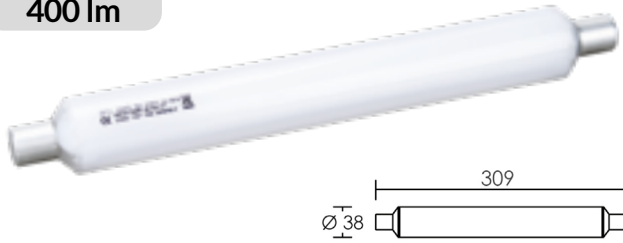

Lampe LINOLITE S19 opale. Remplace les lampes incandescentes. Convient pour les appliques sans diffuseur.

| P (w) | Dim. Ø x L (mm) | Lumens | Teinte   | Code        | € HT         |
|-------|-----------------|--------|----------|-------------|--------------|
| 4     | 38 x 309        | 400    | ● 2700 K | <b>2971</b> | <b>12,00</b> |

## S19 - LINOLITE LED 38 x 310 - 7W



230V

700 lm

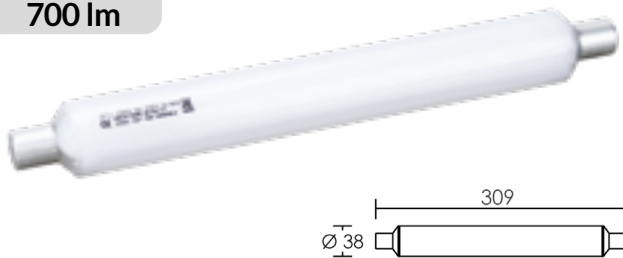

Lampe LINOLITE S19 opale. **LED 20000 h.** Remplace les lampes incandescentes.

| P (w) | Dim. Ø x L (mm) | Lumens | Teinte   | Code        | € HT         |
|-------|-----------------|--------|----------|-------------|--------------|
| 7     | 38 x 309        | 600    | ● 2700 K | <b>2943</b> | <b>12,00</b> |
| 7     | 38 x 309        | 700    | ○ 4000 K | <b>2999</b> | <b>12,00</b> |

## Appareils livrés avec ces lampes :

## TALASSO simple

LED 6W  
Code : 53037  
p. 174



## TALASSO inter

LED 6W  
Code : 53038  
p. 174



## TALASSO inter + prise

LED 6W  
Code : 53039  
p. 174



## TALASSO inter + prise rasoir

LED 6W  
Code : 53040  
p. 174



## NORMARIC B52

LED 4W  
Code : 53027  
p. 178



## NORMARIC B85-C

LED 6W  
Code : 53031  
p. 176



## S14s - CULOTS LATÉRAUX LED

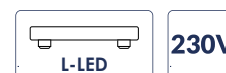

640 lm

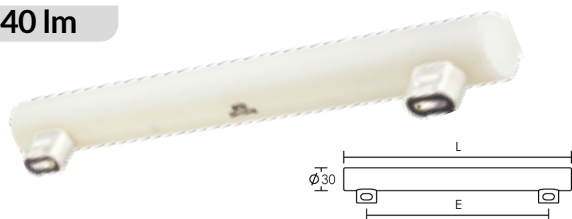

Lampe culots latéraux S14s opale. Culots isolés : 19 x 26 x 14 mm. Remplace les lampes incandescentes.

| P (w) | Dim. Ø x L (mm) | Lumens | Teinte   | Code          | € HT         |
|-------|-----------------|--------|----------|---------------|--------------|
| 4     | 30 x 300        | 320    | ● 2700 K | <b>2871</b>   | <b>28,60</b> |
| 8     | 30 x 500        | 640    | ● 2700 K | <b>2872 *</b> | <b>38,80</b> |

## S14s - CULOTS LATÉRAUX FLUOCOMPACTE

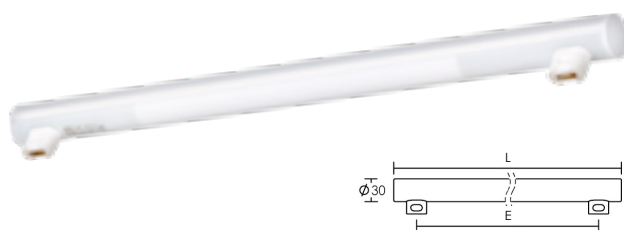

Lampe culots latéraux S14s opale. Culots isolés. Remplace les lampes incandescentes.

| P (w) | Dim. Ø x L (mm) | Lumens | Teinte   | Code        | € HT         |
|-------|-----------------|--------|----------|-------------|--------------|
| 8     | 30 x 300        | 500    | ● 2700 K | <b>2647</b> | <b>17,50</b> |
| 15    | 30 x 500        | 850    | ● 2700 K | <b>2648</b> | <b>18,70</b> |

Ne fonctionne pas sur minuterie et détection de passage.

## S14d - CULOT CENTRAL LED 8W

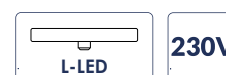

880 lm



Lampe culot central S14d opale. Culot isolé : 22 x 29 x 14 mm. Remplace les lampes incandescentes.

| P (w) | Dim. Ø x L (mm) | Lumens | Teinte   | Code         | € HT         |
|-------|-----------------|--------|----------|--------------|--------------|
| 8     | 30 x 500        | 880    | ● 2700 K | <b>54011</b> | <b>41,80</b> |

### Appareils livrés avec ces lampes :

#### ELASTO LED blanc

> Tube S14d

Code : 54016  
p. 242



#### ELASTO LED jaune

> Tube S14d

Code : 54018  
p. 242



#### ELASTO LED gris

> Tube S14d

Code : 54017  
p. 242

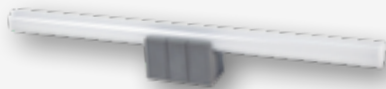

#### SERENA

> Tube S14s

Code : 3931  
p. 184



## CULOTS LATÉRAUX ARIC LED



800 lm

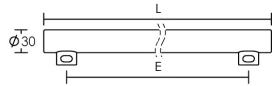

Lampe culots latéraux ARIC opale. Culots ARIC : 16 x 19 x 13 mm. Remplace les lampes incandescentes.

| P (W) | L (mm) | Lumens | Teinte   | Code         | € HT         |
|-------|--------|--------|----------|--------------|--------------|
| 4     | 300    | 320    | ● 2700 K | <b>54000</b> | <b>27,50</b> |
| 6     | 400    | 480    | ● 2700 K | <b>54001</b> | <b>31,60</b> |
| 8     | 500    | 640    | ● 2700 K | <b>54002</b> | <b>34,70</b> |
| 10    | 600    | 800    | ● 2700 K | <b>54003</b> | <b>39,80</b> |

## SOCKET

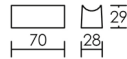
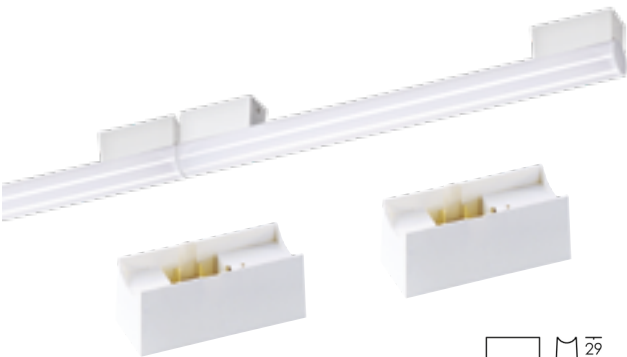

Socket de montage en ligne : bandeau de lumière continue et sans rupture. Douilles (x2) pour lampe culots latéraux ARIC (codes **54000** - **54001** - **54002** - **54003**). Polycarbonate beige.

| Code sans lampe | € HT        |
|-----------------|-------------|
| <b>0702</b>     | <b>8,70</b> |



## TUBE T5 LED

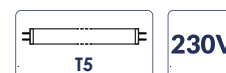

1050 lm

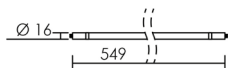

Lampe tube T5 opale. Culot G5, Ø16 mm. Convient pour fonctionnement sur ballast électronique\* en remplacement des T5 fluo.

| P (W) | L (mm) | Lumens | Teinte   | Code        | € HT         |
|-------|--------|--------|----------|-------------|--------------|
| 7     | 549    | 1050   | ○ 4000 K | <b>2876</b> | <b>44,40</b> |

\* Nous ne pouvons garantir la compatibilité avec tous les ballasts du marché. Merci de vous référer aux préconisations d'utilisation ci-contre.

**Lampe de remplacement** pour les réglettes :

- Gamme H2O 14W
- Gamme POP 14W
- Gamme ONDE

## TUBE T8 LED



900 lm

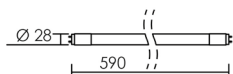

Lampe tube T8 opale. Culot G13, Ø26 mm. **230V direct.**

| P (W) | L (mm) | Lumens | Teinte   | Code        | € HT        |
|-------|--------|--------|----------|-------------|-------------|
| 9     | 590    | 900    | ○ 4000 K | <b>2873</b> | <b>9,90</b> |

## Appareils livrés avec ces lampes :

## ONLINE 9W

&gt; lampe T8 LED

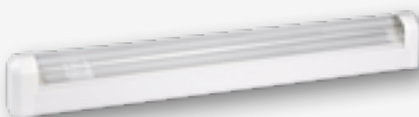

Code : 5425 - 5426 - 5427 - 5428  
p. 172

## H2O

&gt; lampe T5 LED



Code : 53076 - 53077  
p. 173

## DESIGN

&gt; lampe T5 Fluo



Code : 3727  
p. 181

## TUBE T4 / T5 FLUORESCENT



## Tube fluorescent T4 et T5 miniature

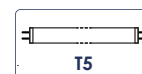

T12 (FD). Culot G5, Ø12 mm.

| P (w) | L (mm) | Lumens | Teinte   | Code        | € HT        |
|-------|--------|--------|----------|-------------|-------------|
| 6     | 205    | 265    | ○ 4000 K | <b>2570</b> | <b>3,30</b> |
| 6     | 205    | 258    | ○ 6400 K | <b>2655</b> | <b>3,80</b> |
| 8     | 327    | 380    | ○ 4000 K | <b>2571</b> | <b>3,20</b> |
| 8     | 327    | 370    | ○ 6400 K | <b>2656</b> | <b>3,90</b> |
| 12    | 355    | 570    | ○ 4000 K | <b>2572</b> | <b>3,50</b> |
| 12    | 355    | 550    | ○ 6400 K | <b>2657</b> | <b>4,00</b> |
| 16    | 454    | 1000   | ○ 4000 K | <b>2573</b> | <b>3,80</b> |
| 16    | 454    | 960    | ○ 6400 K | <b>2658</b> | <b>4,10</b> |
| 20    | 550    | 1450   | ○ 4000 K | <b>2574</b> | <b>3,90</b> |
| 20    | 550    | 1400   | ○ 6400 K | <b>2659</b> | <b>4,10</b> |
| 24    | 641    | 1500   | ○ 6400 K | <b>2660</b> | <b>4,20</b> |
| 30    | 750    | 2000   | ○ 4000 K | <b>2575</b> | <b>4,20</b> |
| 30    | 750    | 1900   | ○ 6400 K | <b>2661</b> | <b>4,20</b> |

T16 (FD). Culot G5, Ø16 mm.

| P (w) | L (mm) | Lumens | Teinte   | Code         | € HT        |
|-------|--------|--------|----------|--------------|-------------|
| 4     | 136    | 130    | ● 3500 K | <b>0850*</b> | <b>2,90</b> |
| 6     | 212    | 280    | ● 3000 K | <b>0853</b>  | <b>2,50</b> |
| 6     | 212    | 280    | ○ 4000 K | <b>2665</b>  | <b>2,50</b> |
| 6     | 212    | 240    | ○ 6500 K | <b>2662</b>  | <b>3,70</b> |
| 8     | 288    | 400    | ● 3000 K | <b>0854</b>  | <b>2,40</b> |
| 8     | 288    | 400    | ○ 4000 K | <b>2666</b>  | <b>2,40</b> |
| 8     | 288    | 340    | ○ 6500 K | <b>2663*</b> | <b>3,90</b> |
| 13    | 517    | 880    | ● 3000 K | <b>0855</b>  | <b>3,20</b> |
| 13    | 517    | 880    | ○ 4000 K | <b>2667</b>  | <b>3,20</b> |
| 13    | 517    | 750    | ○ 6500 K | <b>2664</b>  | <b>5,60</b> |

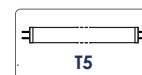
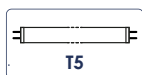

## Tube fluorescent T5 HE et HO

T16 (FDH). Culot G5, Ø16 mm. Tubes **HE** - haute efficacité - 100 Lumens/Watt.

| P (w) | L (mm) | Lumens | Teinte   | Code        | € HT        |
|-------|--------|--------|----------|-------------|-------------|
| 14    | 549    | 1200   | ● 3000 K | <b>2861</b> | <b>6,20</b> |
| 14    | 549    | 1200   | ○ 4000 K | <b>2862</b> | <b>6,20</b> |
| 21    | 849    | 1900   | ● 3000 K | <b>2863</b> | <b>8,30</b> |
| 21    | 849    | 1900   | ○ 4000 K | <b>2668</b> | <b>8,80</b> |
| 21    | 849    | 1750   | ○ 6500 K | <b>2627</b> | <b>6,80</b> |
| 28    | 1149   | 2600   | ● 3000 K | <b>2864</b> | <b>8,90</b> |
| 28    | 1149   | 2600   | ○ 4000 K | <b>2669</b> | <b>9,30</b> |
| 28    | 1149   | 2400   | ○ 6500 K | <b>2628</b> | <b>9,00</b> |
| 35    | 1445   | 3320   | ● 3000 K | <b>2865</b> | <b>9,40</b> |
| 35    | 1445   | 3320   | ○ 4000 K | <b>2626</b> | <b>7,10</b> |

T16 (FDHS). Culot G5, Ø16 mm. Tubes **HO** - flux lumineux élevé - 80 Lumens/Watt.

| P (w) | L (mm) | Lumens | Teinte   | Code         | € HT        |
|-------|--------|--------|----------|--------------|-------------|
| 24    | 549    | 1750   | ○ 4000 K | <b>2588*</b> | <b>6,30</b> |
| 39    | 849    | 3100   | ● 3000 K | <b>2866</b>  | <b>6,90</b> |
| 39    | 849    | 3100   | ○ 4000 K | <b>2589</b>  | <b>7,10</b> |
| 54    | 1149   | 4450   | ● 3000 K | <b>2867</b>  | <b>7,40</b> |
| 54    | 1149   | 4450   | ○ 4000 K | <b>2590</b>  | <b>7,90</b> |



LAMPE À DÉCHARGE

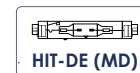
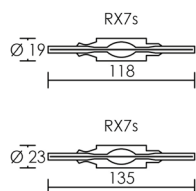

Lampe iodures brûleur quartz. Culot RX7s.

| P (W) | L (mm) | Lumens | Teinte   | Code        | € HT         |
|-------|--------|--------|----------|-------------|--------------|
| 70    | 118    | 5925   | ● 3300 K | <b>2857</b> | <b>26,20</b> |
| 70    | 118    | 6500   | ○ 4200 K | <b>2601</b> | <b>26,20</b> |
| 150   | 135    | 12000  | ● 3100 K | <b>2858</b> | <b>26,20</b> |
| 150   | 135    | 12500  | ○ 4200 K | <b>2603</b> | <b>26,20</b> |

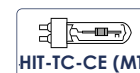
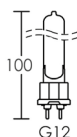

Lampe iodures brûleur céramique. Culot G12.

| P (W) | L (mm) | Lumens | Teinte   | Code        | € HT         |
|-------|--------|--------|----------|-------------|--------------|
| 70    | 100    | 7000   | ● 3000 K | <b>2611</b> | <b>52,90</b> |
| 70    | 100    | 7000   | ○ 4200 K | <b>2696</b> | <b>52,90</b> |

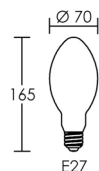

Lampe sodium ovoïde. Tension : platine.

| P (W) | Culot | Lumens | Teinte   | Code        | € HT         |
|-------|-------|--------|----------|-------------|--------------|
| 70    | E27   | 6040   | ● 2000 K | <b>2552</b> | <b>22,50</b> |



# SOMMAIRE | DOWNLIGHT ENCASTRÉ

## DALLES LED

DALLE PREMIUM ...p. 43



DALLE BKL PREMIUM  
600X600 ...p. 44



DALLE BKL PREMIUM  
300X1200 ...p. 44



DALLE BKL ...p. 45



## DOWNLIGHT

Diamètre > 100 mm

LEDIUM ...p. 46



FLAT-ISO CCT ...p. 47



HARDEN ...p. 48



IVARO ...p. 49



BIRDY ...p. 50



GRACE ...p. 51



RIVA ...p. 52



FORTISSIMO ...p. 52



START CCT ...p. 53



FLAT ...p. 54



FLAT CCT ...p. 55



UNIVERSAL ...p. 56



RANDY ...p. 58



METROPOLIS ...p. 61



QUADRA ...p. 62



## ENCASTRÉ RECOUVRABLE

Diamètre < 100 mm

DLT-ISO 75/90 ...p. 66



DL-ISO IP20 ...p. 67



EF6 ...p. 68



EF6 CCT ...p. 69



EF7 ...p. 70



EF7 CCT ...p. 70



AIR BLOCK 2 ...p. 71



AQUAFLAT ...p. 72



AQUA PRO ...p. 73



AXEL ...p. 74



LOKI ...p. 75



DL-ISO IP65 ...p. 76



P10 ...p. 76



DL 084 ...p. 77



HIDRO 50 XL6 ...p. 77



## ENCASTRÉ IP44/65

Diamètre < 100 mm

GRACE ...p. 78



KIT ELITE F4 ...p. 78



AVERY ...p. 79



BIRDY ...p. 79



CLASSO ...p. 80



ASPEN ...p. 81



KIT LUCIA XL6 ...p. 81



HIDRO ...p. 82



ZETA ...p. 84



SPEED 50 IP65 ...p. 85







# SOMMAIRE | DOWNLIGHT ENCASTRÉ

## ENCASTRÉ IP20

Diamètre < 100 mm

|  |  |  |   |   |
|--|--|--|---|---|
| <b>ELODY</b> ...p. 86<br>       | <b>EYDI</b> ...p. 86<br>        | <b>MI6</b> ...p. 87<br>         | <b>ELITE</b> ...p. 88<br>       | <b>RANDY S</b> ...p. 90<br>    |
| <b>DL-ISO IP20</b> ...p. 90<br> | <b>RIVA 10W</b> ...p. 91<br>    | <b>K8</b> ...p. 91<br>          | <b>FLAT 5W</b> ...p. 92<br>     | <b>MI5</b> ...p. 92<br>        |
| <b>MICRO LEM</b> ...p. 93<br>   | <b>SPEED 50</b> ...p. 94<br>    | <b>SPEED 70</b> ...p. 95<br>    | <b>SPEED 90</b> ...p. 96<br>    | <b>SPEED 110</b> ...p. 96<br>  |
| <b>SPOTISOL</b> ...p. 97<br>    | <b>TIPO</b> ...p. 98<br>        | <b>GALAXY</b> ...p. 100<br>     | <b>LUNAR</b> ...p. 102<br>      | <b>FIXO</b> ...p. 104<br>      |
| <b>DISK</b> ...p. 105<br>       | <b>SATURNE</b> ...p. 105<br>    | <b>SQUARE</b> ...p. 106<br>     | <b>QUADRA 110</b> ...p. 107<br> | <b>TOP 0</b> ...p. 107<br>     |
| <b>EN 63</b> ...p. 108<br>    | <b>MINI SAT</b> ...p. 108<br> | <b>LUNAR 35</b> ...p. 108<br> | <b>LUCIA 1</b> ...p. 109<br> | <b>LUCIA 2</b> ...p. 109<br> |

## ENCASTRÉ DE MEUBLE

|   |   |   |   |  |
|---|---|---|---|--|
| <b>FLAT 5</b> ...p. 110<br>      | <b>MI5</b> ...p. 110<br>       | <b>MI6</b> ...p. 110<br>       | <b>MICRO LEM</b> ...p. 111<br>   | <b>PEARL 2</b> ...p. 111<br>                |
| <b>SPARK</b> ...p. 112<br>       | <b>SENSO LED</b> ...p. 113<br> | <b>MEUBLED 2</b> ...p. 114<br> | <b>MEUBLED IP65</b> ...p. 115<br> | <b>S 1200 LED / S 307 LED</b> ...p. 116<br> |
| <b>ACCESSOIRES</b> ...p. 117<br> |   |   |   |  |

## ENCASTRÉ DE MUR

|  |   |   |   |  |
|--|---|---|---|--|
| <b>RUSSEL</b> ...p. 118<br> | <b>BALIZ 2</b> ...p. 119<br> | <b>BALIZ 3</b> ...p. 119<br> | <b>BALIZ 1</b> ...p. 120<br> | <b>MURO 1</b> ...p. 120<br> |
| <b>ISO</b> ...p. 121<br>    |   |   |   |  |

ACCESSOIRES DALLE LED

ECARTEUR ISOLANT LED



Vidéo de présentation

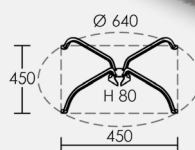
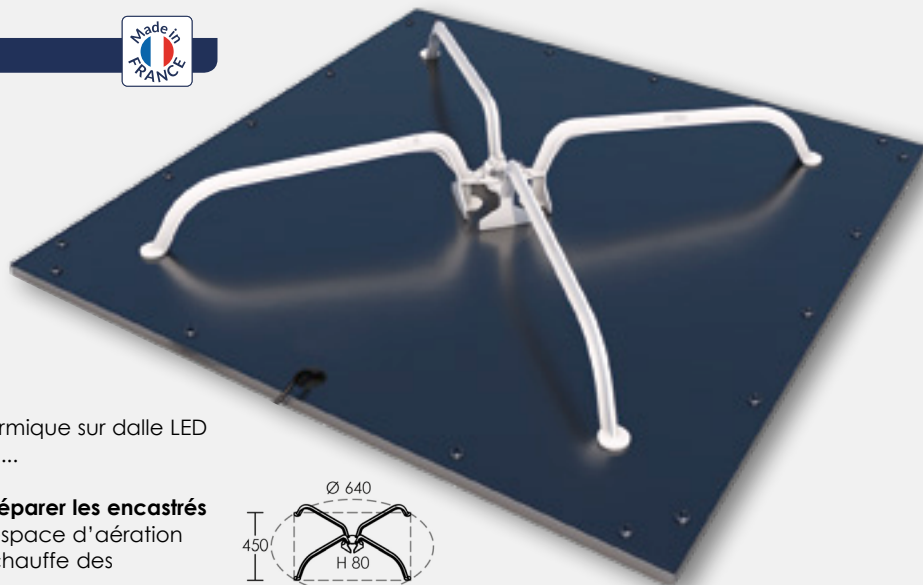

Accessoire pour pose d'isolant thermique sur dalle LED et encastré LED, type FLAT, LEDIUM...

L'écarteur Isolant LED permet de **séparer les encastrés de l'isolant rouleau** en créant un espace d'aération thermique. Evite les risques de surchauffe des appareils (LED et alimentations).

- Diamètre minimum 120 mm ;
- Hauteur : 80 mm ;
- Utilisable de -20°C à +45°C ;
- Résistance au feu : auto-extinguible UL94 V2.

| Code | € HT  |
|------|-------|
| 3671 | 12,20 |

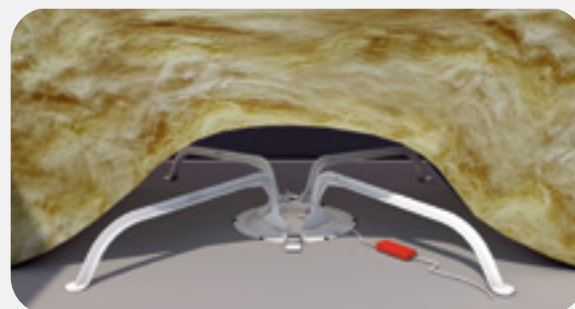

ALIMENTATION

| Désignation   | Code  | € HT  |
|---|-------|-------|
| (1) Alimentation 44W, classe 2, IP20, dimmable par coupure de phase. Précâblée avec connecteur. L x l x h = 123 x 79 x 30 mm                      | 52026 | 26,50 |
| <b>N</b> (2) Alimentation 48W, dimmable DALI. Convient pour gamme PREMIUM, ACCESS et BKL. Précâblée avec connecteur. L x l x h = 103 x 68 x 30 mm | 52030 | 65,00 |

ACCESSOIRES D'INSTALLATION

| Désignation   | Code | € HT  |
|---|------|-------|
| (1) Filins de suspension (x 4) Longueur 1 m                 | 0097 | 10,20 |
| (2) Cadre pour montage applique (sans vis apparente)        | 0099 | 18,40 |
| (3) Ressorts de fixation (x 4) pour montage encastré        | 0098 | 10,20 |
| (4) Kit de sécurité de recharge (1 filin acier + fixations) | 0103 | 2,00  |



## DALLE LED - PREMIUM



FLICKER  
FREE



230V

IP  
20



650°C



Jusqu'à  
**3800 lm**

Cadre aluminium blanc/Diffuseur prismatique PMMA blanc. Fixe. Extra-plat : 9 mm.  
Installation encastrée recommandée. Kit de sécurité fourni prémonté. **Alimentation séparée fournie.**



Diffuseur prismatique

### Fourni avec alimentation DIMMABLE



| ◁ 80° |        | 50 000 h |              |              |  |
|-------|--------|----------|--------------|--------------|--|
| P (w) | Lumens | Teinte   | Code         | € HT         |  |
| 40    | 3500   | ● 3000 K | <b>50781</b> | <b>90,80</b> |  |
| 40    | 3800   | ○ 4000 K | <b>50782</b> | <b>90,80</b> |  |

Dimmable par coupure de phase.

### Fourni avec alimentation NON DIMMABLE

| ◁ 80° |        | 50 000 h |              |              |  |
|-------|--------|----------|--------------|--------------|--|
| P (w) | Lumens | Teinte   | Code         | € HT         |  |
| 40    | 3500   | ● 3000 K | <b>50739</b> | <b>74,50</b> |  |
| 40    | 3800   | ○ 4000 K | <b>50740</b> | <b>74,50</b> |  |

| 50739 | 3000K                 | 40 W  | 80° |
|-------|-----------------------|-------|-----|
| h (m) | E <sub>max</sub> (lx) | d (m) |     |
| 1     | <b>1849</b>           | 1,68  |     |
| 2     | <b>462</b>            | 3,4   |     |
| 3     | <b>205</b>            | 5,0   |     |

| 50740 | 4000K                 | 40 W  | 80° |
|-------|-----------------------|-------|-----|
| h (m) | E <sub>max</sub> (lx) | d (m) |     |
| 1     | <b>2007</b>           | 1,68  |     |
| 2     | <b>502</b>            | 3,4   |     |
| 3     | <b>223</b>            | 5,0   |     |



**Kit de sécurité  
fourni prémonté**

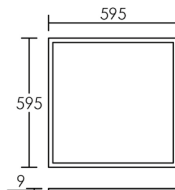

## DALLE LED - BKL PREMIUM 600 x 600



3600 lm

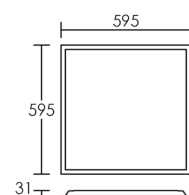

|       |              |                             |              |
|-------|--------------|-----------------------------|--------------|
| 50799 | 4000K        | 40W                         | 90°          |
|       | <b>h (m)</b> | <b>E<sub>max</sub> (lx)</b> | <b>d (m)</b> |
|       | 1            | 1458                        | 2,00         |
|       | 2            | 365                         | 4,0          |
|       | 3            | 162                         | 6,0          |

Cadre aluminium blanc/Diffuseur PMMA blanc. Fixe. Installation encastrée recommandée. Kit de sécurité fourni prémonté. **Alimentation séparée fournie non dimmable.**

|             |        |          |              |              |
|-------------|--------|----------|--------------|--------------|
| ◁ 90°       |        |          |              | 50 000 h     |
| P (w)       | Lumens | Teinte   | Code         | € HT         |
| <b>N</b> 40 | 3600   | ○ 4000 K | <b>50799</b> | <b>56,00</b> |

## DALLE LED - BKL PREMIUM 300 x 1200



3600 lm

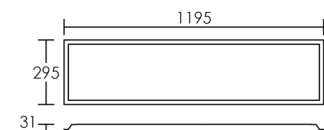

|       |              |                             |              |
|-------|--------------|-----------------------------|--------------|
| 50800 | 4000K        | 40W                         | 90°          |
|       | <b>h (m)</b> | <b>E<sub>max</sub> (lx)</b> | <b>d (m)</b> |
|       | 1            | 1458                        | 2,00         |
|       | 2            | 365                         | 4,0          |
|       | 3            | 162                         | 6,0          |

Cadre aluminium blanc/Diffuseur PMMA blanc. Fixe. Installation encastrée recommandée. Kit de sécurité fourni prémonté. **Alimentation séparée fournie non dimmable.**

|             |        |          |              |              |
|-------------|--------|----------|--------------|--------------|
| ◁ 90°       |        |          |              | 50 000 h     |
| P (w)       | Lumens | Teinte   | Code         | € HT         |
| <b>N</b> 40 | 3600   | ○ 4000 K | <b>50800</b> | <b>66,00</b> |

## DALLE LED - BKL



FLICKER FREE



230V



3600 lm



Cadre aluminium blanc/Diffuseur PMMA blanc. Fixe. Installation encastrée recommandée. Kit de sécurité fourni prémonté. **Alimentation séparée fournie non dimmable.**

**Kit de sécurité**  
fourni prémonté

|        |       |        |          |              |                 |
|--------|-------|--------|----------|--------------|-----------------|
| ◁ 120° |       |        |          |              | <b>50 000 h</b> |
|        | P (W) | Lumens | Teinte   | Code         | € HT            |
| N      | 40    | 3600   | ○ 4000 K | <b>50798</b> | <b>37,00</b>    |

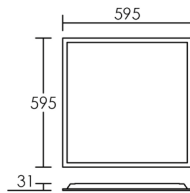

|  |              |              |                             |              |
|--|--------------|--------------|-----------------------------|--------------|
|  | <b>50798</b> | <b>4000K</b> | <b>40W</b>                  | <b>120°</b>  |
|  |              | <b>h (m)</b> | <b>E<sub>max</sub> (lx)</b> | <b>d (m)</b> |
|  |              | 1            | <b>1060</b>                 | 3,46         |
|  |              | 2            | <b>265</b>                  | 6,9          |
|  | 3            | <b>118</b>   | 10,4                        |              |

## ACCESSOIRES GAMME BKL



|       | Désignation  | Code         | € HT         |
|-------|--|--------------|--------------|
|       | Kit de sécurité de rechange (filin acier 1 m ajustable)  | <b>0103</b>  | <b>2,00</b>  |
| (1)   | Alimentation 44W, classe 2, IP20, dimmable par coupure de phase. Précâblée avec connecteur. L x l x h = 123 x 79 x 30 mm             | <b>52026</b> | <b>26,50</b> |
| N (2) | Alimentation 48W, dimmable DALI. Convient pour gamme PREMIUM, ACCESS et BKL. Précâblée avec connecteur. L x l x h = 103 x 68 x 30 mm | <b>52030</b> | <b>65,00</b> |

**LEDIUM**



Jusqu'à  
**2400 lm**



Version 10W



Version 15W

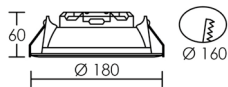

Versions 20W - 25W - 30W

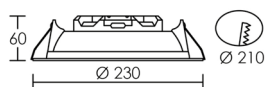

Corps et diffuseur thermoplastique blanc. Fixe. LED SMD. **Alimentation intégrée.**

|               |          |        |              | 25 000 h     |  |
|---------------|----------|--------|--------------|--------------|--|
| P (w)         | Faisceau | Lumens | Code         | € HT         |  |
| <b>3000 K</b> |          |        |              |              |  |
| 10            | 110°     | 750    | <b>50454</b> | <b>36,70</b> |  |
| 15            | 110°     | 1150   | <b>50417</b> | <b>41,60</b> |  |
| 20            | 110°     | 1550   | <b>50418</b> | <b>46,90</b> |  |
| 25            | 110°     | 1950   | <b>50419</b> | <b>57,10</b> |  |
| 30            | 100°     | 2350   | <b>50420</b> | <b>62,00</b> |  |
| <b>4000 K</b> |          |        |              |              |  |
| 10            | 110°     | 800    | <b>50360</b> | <b>36,70</b> |  |
| 15            | 110°     | 1200   | <b>50377</b> | <b>41,60</b> |  |
| 20            | 110°     | 1600   | <b>50361</b> | <b>46,90</b> |  |
| 25            | 110°     | 2000   | <b>50362</b> | <b>57,10</b> |  |
| 30            | 100°     | 2400   | <b>50363</b> | <b>62,00</b> |  |

**CÔNES GAMME LEDIUM**

| Code  | Température | P (W) | Faisceau | h (m) | E <sub>max</sub> (lx) | d (m) |
|-------|-------------|-------|----------|-------|-----------------------|-------|
| 50454 | 3000K       | 10 W  | 110°     | 1     | 284                   | 2,86  |
|       |             |       |          | 2     | 71                    | 5,7   |
|       |             |       |          | 3     | 32                    | 8,6   |
| 50417 | 3000 K      | 15 W  | 110°     | 1     | 442                   | 2,86  |
|       |             |       |          | 2     | 110                   | 5,7   |
|       |             |       |          | 2,5   | 71                    | 7,1   |
| 50418 | 3000 K      | 20 W  | 110°     | 1     | 596                   | 2,86  |
|       |             |       |          | 2     | 149                   | 5,7   |
|       |             |       |          | 2,5   | 95                    | 7,1   |
| 50419 | 3000 K      | 25 W  | 110°     | 1     | 749                   | 2,86  |
|       |             |       |          | 2     | 187                   | 5,7   |
|       |             |       |          | 2,5   | 120                   | 7,1   |
| 50420 | 3000 K      | 30 W  | 100°     | 1     | 981                   | 2,38  |
|       |             |       |          | 2     | 245                   | 4,8   |
|       |             |       |          | 3     | 109                   | 7,2   |
| 50360 | 4000 K      | 10 W  | 110°     | 1     | 303                   | 2,86  |
|       |             |       |          | 2     | 76                    | 5,7   |
|       |             |       |          | 2,5   | 49                    | 7,1   |
| 50377 | 4000 K      | 15 W  | 110°     | 1     | 461                   | 2,86  |
|       |             |       |          | 2     | 115                   | 5,7   |
|       |             |       |          | 2,5   | 74                    | 7,1   |
| 50361 | 4000 K      | 20 W  | 110°     | 1     | 619                   | 2,86  |
|       |             |       |          | 2     | 155                   | 5,7   |
|       |             |       |          | 2,5   | 99                    | 7,1   |
| 50362 | 4000 K      | 25 W  | 110°     | 1     | 763                   | 2,86  |
|       |             |       |          | 2     | 191                   | 5,7   |
|       |             |       |          | 3     | 85                    | 8,6   |
| 50363 | 4000 K      | 30 W  | 100°     | 1     | 1002                  | 2,38  |
|       |             |       |          | 2     | 250                   | 4,8   |
|       |             |       |          | 3     | 111                   | 7,2   |

FLAT-ISO CCT



Jusqu'à  
**1700 lm**

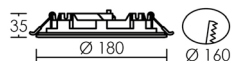

Versions 13W

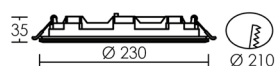

Versions 20W

Corps thermoplastique blanc. Fixe. LED SMD.  
**Alimentation intégrée.**

|       |        | ◁110° ○3000 K/○4000 K |              | 30 000 h     |  |
|-------|--------|-----------------------|--------------|--------------|--|
| P (w) | Lumens | Couleur               | Code         | € HT         |  |
| 13    | 1050   | blanc                 | <b>50701</b> | <b>41,80</b> |  |
| 13    | 1050   | noir                  | <b>50702</b> | <b>41,80</b> |  |
| 20    | 1700   | blanc                 | <b>50703</b> | <b>49,00</b> |  |
| 20    | 1700   | noir                  | <b>50704</b> | <b>49,00</b> |  |

Données de la LED en 4000 K.

Réglage de la température de couleur

○ 3000 K ou ○ 4000 K  
par interrupteur à l'arrière du spot.

| 50701 | 4000K                 | 13W   | 110° |
|-------|-----------------------|-------|------|
| h (m) | E <sub>max</sub> (lx) | d (m) |      |
| 1     | <b>417</b>            | 2,86  |      |
| 2     | <b>104</b>            | 5,71  |      |
| 2,5   | <b>67</b>             | 7,14  |      |

| 50703 | 4000K                 | 20W   | 110° |
|-------|-----------------------|-------|------|
| h (m) | E <sub>max</sub> (lx) | d (m) |      |
| 1     | <b>696</b>            | 2,86  |      |
| 2     | <b>174</b>            | 5,71  |      |
| 2,5   | <b>111</b>            | 7,14  |      |

# HARDEN



Jusqu'à  
**3500 lm**

Corps polycarbonate blanc équipé d'un radiateur en aluminium noir/Diffuseur opale en retrait. Spot classe 3.  
**Alimentation classe 2 séparée précâblée.**

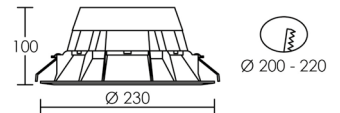

## Versions 14W - 20W



|       |        |          |              | 80°          | 35 000 h |
|-------|--------|----------|--------------|--------------|----------|
| P (w) | Lumens | Teinte   | Code         | € HT         |          |
| 14    | 2100   | ○ 4000 K | <b>50220</b> | <b>85,70</b> |          |
| 20    | 2700   | ○ 4000 K | <b>50221</b> | <b>92,80</b> |          |

## Version 28W



|       |        |          |              | 80°          | 35 000 h |
|-------|--------|----------|--------------|--------------|----------|
| P (w) | Lumens | Teinte   | Code         | € HT         |          |
| 28    | 3500   | ○ 4000 K | <b>50222</b> | <b>97,90</b> |          |

## CÔNES GAMME HARDEN

| 50220 | 4000K                 | 14W   | 80° |  |  |  |
|-------|-----------------------|-------|-----|--|--|--|
| h (m) | E <sub>max</sub> (lx) | d (m) |     |  |  |  |
| 1     | 1170                  | 1,68  |     |  |  |  |
| 2     | 293                   | 3,4   |     |  |  |  |
| 3     | 130                   | 5,0   |     |  |  |  |

| 50221 | 4000K                 | 20W   | 80° |  |  |  |
|-------|-----------------------|-------|-----|--|--|--|
| h (m) | E <sub>max</sub> (lx) | d (m) |     |  |  |  |
| 1     | 1507                  | 1,68  |     |  |  |  |
| 2     | 377                   | 3,4   |     |  |  |  |
| 3     | 167                   | 5,0   |     |  |  |  |

| 50222 | 4000K                 | 28W   | 80° |  |  |  |
|-------|-----------------------|-------|-----|--|--|--|
| h (m) | E <sub>max</sub> (lx) | d (m) |     |  |  |  |
| 1     | 1958                  | 1,68  |     |  |  |  |
| 2     | 490                   | 3,4   |     |  |  |  |
| 3     | 218                   | 5,0   |     |  |  |  |



IVARO



Jusqu'à  
3500 lm

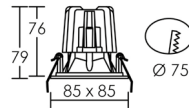
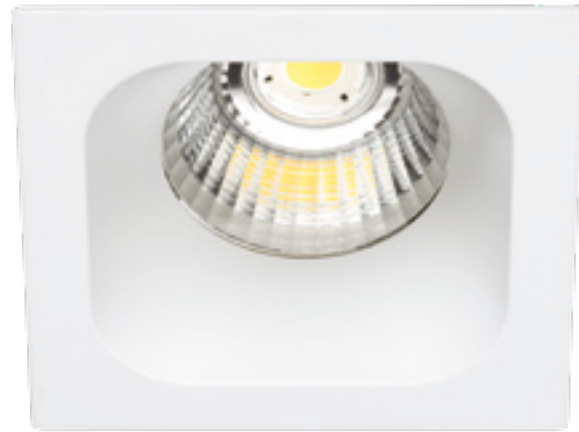

Version 7,5W

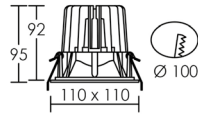

Version 13W

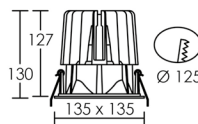

Version 34W

Corps aluminium injecté blanc/Réflecteur aluminisé/  
Verre de protection. Fixe. LED en retrait : haut confort  
visuel, pas d'éblouissement. Spot classe 3. Alimentation  
classe 2, séparée fournie.

| ○ 4000 K |          |        |              | 40 000 h      |
|----------|----------|--------|--------------|---------------|
| P (w)    | Faisceau | Lumens | Code         | € HT          |
| 7,5      | 36°      | 620    | <b>50444</b> | <b>50,30</b>  |
| 13       | 40°      | 1 100  | <b>50445</b> | <b>77,50</b>  |
| 34       | 65°      | 3 500  | <b>50446</b> | <b>116,30</b> |

CÔNES GAMME IVARO

| 50444 | 4000K                 | 10,5W | 30° |
|-------|-----------------------|-------|-----|
| h (m) | E <sub>max</sub> (lx) | d (m) |     |
| 1     | 2416                  | 0,54  |     |
| 2     | 604                   | 1,1   |     |
| 3     | 268                   | 1,6   |     |

| 50445 | 4000K                 | 13 W  | 36° |
|-------|-----------------------|-------|-----|
| h (m) | E <sub>max</sub> (lx) | d (m) |     |
| 1     | 2555                  | 0,65  |     |
| 2     | 639                   | 1,3   |     |
| 3     | 284                   | 1,9   |     |

| 50446 | 4000K                 | 34 W  | 65° |
|-------|-----------------------|-------|-----|
| h (m) | E <sub>max</sub> (lx) | d (m) |     |
| 1     | 3090                  | 1,27  |     |
| 2     | 773                   | 2,5   |     |
| 3     | 343                   | 3,8   |     |

# BIRDY



800 lm



Corps thermoplastique. Fixe, blanc. LED SMD.  
Alimentation intégrée précâblée 0,15 m.

110° 40 000 h

| P (w) | Lumens | Teinte | Code  | € HT  |
|-------|--------|--------|-------|-------|
| 9     | 800    | 3000 K | 50039 | 33,00 |
| 9     | 800    | 4000 K | 50040 | 33,00 |

Dimmable par coupure de phase.

| 50039 | 3000K                 | 9W    | 110° |
|-------|-----------------------|-------|------|
| h (m) | E <sub>max</sub> (lx) | d (m) |      |
| 1     | 287                   | 2,86  |      |
| 2     | 72                    | 5,7   |      |
| 3     | 32                    | 8,6   |      |

| 50040 | 4000K                 | 9W    | 110° |
|-------|-----------------------|-------|------|
| h (m) | E <sub>max</sub> (lx) | d (m) |      |
| 1     | 287                   | 2,86  |      |
| 2     | 72                    | 5,7   |      |
| 3     | 32                    | 8,6   |      |

## ACCESSOIRES BIRDY



| Couleur     | Code  | € HT |
|-------------|-------|------|
| alu. brossé | 50059 | 8,70 |
| chrome      | 50061 | 8,70 |

## Gamme BIRDY

- ✓ Même diamètre de découpe que les encastrés R80
- ✓ Collerette décorative à clipser : existe en blanc, alu. brossé ou chromé

Convient pour salle de bain et extérieur protégé

GRACE



Jusqu'à  
**1620 lm**

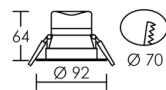

Versions 5W - 7W

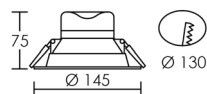

Version 12W

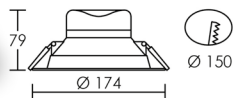

Versions 17W

Corps polycarbonate/Dissipateur thermique en aluminium surmoulé. Vasque polycarbonate opale.  
**Alimentation intégrée.**

| ◀ 90° |        |          |              | 30 000 h     |
|-------|--------|----------|--------------|--------------|
| P (w) | Lumens | Teinte   | Code         | € HT         |
| 5     | 440    | ● 3000 K | <b>50330</b> | <b>14,30</b> |
| 5     | 460    | ○ 4000 K | <b>50332</b> | <b>14,30</b> |
| 7     | 630    | ● 3000 K | <b>50331</b> | <b>20,40</b> |
| 7     | 660    | ○ 4000 K | <b>50333</b> | <b>20,40</b> |
| 12    | 1150   | ○ 4000 K | <b>50334</b> | <b>44,70</b> |
| 17    | 1620   | ○ 4000 K | <b>50335</b> | <b>50,90</b> |

CÔNES GAMME GRACE

| 50330 | 3000 K                | 5 W   | 90° |
|-------|-----------------------|-------|-----|
| h (m) | E <sub>max</sub> (lx) | d (m) |     |
| 1     | <b>219</b>            | 2,00  |     |
| 2     | <b>55</b>             | 4,0   |     |
| 3     | <b>24</b>             | 6,0   |     |

| 50331 | 3000 K                | 7 W   | 90° |
|-------|-----------------------|-------|-----|
| h (m) | E <sub>max</sub> (lx) | d (m) |     |
| 1     | <b>292</b>            | 2,00  |     |
| 2     | <b>73</b>             | 4,0   |     |
| 3     | <b>32</b>             | 6,0   |     |

| 50332 | 4000 K                | 5 W   | 90° |
|-------|-----------------------|-------|-----|
| h (m) | E <sub>max</sub> (lx) | d (m) |     |
| 1     | <b>229</b>            | 2,00  |     |
| 2     | <b>57</b>             | 4,0   |     |
| 3     | <b>25</b>             | 6,0   |     |

| 50333 | 4000 K                | 7 W   | 90° |
|-------|-----------------------|-------|-----|
| h (m) | E <sub>max</sub> (lx) | d (m) |     |
| 1     | <b>326</b>            | 2,00  |     |
| 2     | <b>82</b>             | 4,0   |     |
| 3     | <b>36</b>             | 6,0   |     |

| 50334 | 4000 K                | 12 W  | 90° |
|-------|-----------------------|-------|-----|
| h (m) | E <sub>max</sub> (lx) | d (m) |     |
| 1     | <b>483</b>            | 2,00  |     |
| 2     | <b>121</b>            | 4,0   |     |
| 3     | <b>54</b>             | 6,0   |     |

| 50335 | 4000 K                | 17 W  | 90° |
|-------|-----------------------|-------|-----|
| h (m) | E <sub>max</sub> (lx) | d (m) |     |
| 1     | <b>680</b>            | 2,00  |     |
| 2     | <b>170</b>            | 4,0   |     |
| 3     | <b>76</b>             | 6,0   |     |

RIVA



Jusqu'à  
**2500 lm**

Corps et réflecteur aluminium. Fixe. Précâblage 0,25 m. Alimentation 350mA séparée pré-câblée, classe 2, IP20.

Version 10W



◁50° **35 000 h**

| P (w) | Lumens | Teinte   | Code         | € HT         |
|-------|--------|----------|--------------|--------------|
| 10    | 900    | ● 3000 K | <b>50600</b> | <b>39,80</b> |
| 10    | 950    | ○ 4000 K | <b>50601</b> | <b>39,80</b> |

Dimmable par coupure de phase.

| 50600 | 3000K                 | 10 W  | 50° |
|-------|-----------------------|-------|-----|
| h (m) | E <sub>max</sub> (lx) | d (m) |     |
| 1     | <b>1284</b>           | 0,93  |     |
| 2     | <b>321</b>            | 1,9   |     |
| 3     | <b>143</b>            | 2,8   |     |

| 50601 | 4000K                 | 10 W  | 50° |
|-------|-----------------------|-------|-----|
| h (m) | E <sub>max</sub> (lx) | d (m) |     |
| 1     | <b>1377</b>           | 0,93  |     |
| 2     | <b>344</b>            | 1,9   |     |
| 3     | <b>153</b>            | 2,8   |     |

Version 28W



◁55° **35 000 h**

| P (w) | Lumens | Teinte   | Code         | € HT         |
|-------|--------|----------|--------------|--------------|
| 28    | 2400   | ● 3000 K | <b>50602</b> | <b>66,30</b> |
| 28    | 2500   | ○ 4000 K | <b>50603</b> | <b>66,30</b> |

Dimmable par coupure de phase.

| 50602 | 3000K                 | 28 W  | 55° |
|-------|-----------------------|-------|-----|
| h (m) | E <sub>max</sub> (lx) | d (m) |     |
| 1     | <b>2642</b>           | 1,04  |     |
| 2     | <b>661</b>            | 2,1   |     |
| 3     | <b>294</b>            | 3,1   |     |

| 50603 | 4000K                 | 28 W  | 55° |
|-------|-----------------------|-------|-----|
| h (m) | E <sub>max</sub> (lx) | d (m) |     |
| 1     | <b>2794</b>           | 1,04  |     |
| 2     | <b>699</b>            | 2,1   |     |
| 3     | <b>310</b>            | 3,1   |     |

FORTISSIMO



**2400 lm**

Corps acier blanc/Réflecteur aluminium. Orientable. Module LED FORTIMO® DLM Flex Philips intégré.

Alimentation séparée fournie.



◁60° **25 000 h**

| P (w) | Lumens | Teinte   | Code        | € HT          |
|-------|--------|----------|-------------|---------------|
| 27    | 2200   | ● 3000 K | <b>5141</b> | <b>181,60</b> |
| 27    | 2400   | ○ 4000 K | <b>5142</b> | <b>181,60</b> |

Dimmable par bouton poussoir ou commande DALI.

| 5141  | 3000 K                | 27 W  | 60° |
|-------|-----------------------|-------|-----|
| h (m) | E <sub>max</sub> (lx) | d (m) |     |
| 1     | <b>2196</b>           | 1,15  |     |
| 2     | <b>549</b>            | 2,3   |     |
| 3     | <b>244</b>            | 3,5   |     |

| 5142  | 4000 K                | 27 W  | 60° |
|-------|-----------------------|-------|-----|
| h (m) | E <sub>max</sub> (lx) | d (m) |     |
| 1     | <b>2396</b>           | 1,15  |     |
| 2     | <b>599</b>            | 2,3   |     |
| 3     | <b>266</b>            | 3,5   |     |

START CCT



Jusqu'à  
**3400 lm**

Colerette aluminium blanc/Radiateur aluminium à ailettes. Diffuseur polycarbonate opale en retrait.  
Réglage de la température de couleur (3000 K ou 4000 K) par interrupteur sur boîtier déporté à l'arrière du produit.  
**Alimentation séparée fournie.**

Version 120

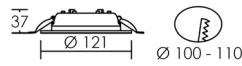

◀100° ○3000 K/○4000 K **50 000 h**

| P (w)       | Lumens | Couleur | Code         | € HT         |
|-------------|--------|---------|--------------|--------------|
| <b>N</b> 12 | 1200   | blanc   | <b>50742</b> | <b>28,00</b> |

**Dimmable par coupure de fin de phase.**  
Données de la LED en 4000 K.

| h (m) | E <sub>max</sub> (lx) | d (m) |
|-------|-----------------------|-------|
| 1     | <b>488</b>            | 2,38  |
| 2     | <b>122</b>            | 4,8   |
| 3     | <b>54</b>             | 7,2   |

Version 170

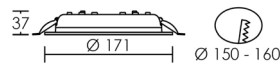

◀100° ○3000 K/○4000 K **50 000 h**

| P (w)       | Lumens | Couleur | Code         | € HT         |
|-------------|--------|---------|--------------|--------------|
| <b>N</b> 24 | 2800   | blanc   | <b>50743</b> | <b>42,00</b> |

**Dimmable par coupure de fin de phase.**  
Données de la LED en 4000 K.

| h (m) | E <sub>max</sub> (lx) | d (m) |
|-------|-----------------------|-------|
| 1     | <b>1092</b>           | 2,38  |
| 2     | <b>273</b>            | 4,8   |
| 3     | <b>121</b>            | 7,2   |

Version 230

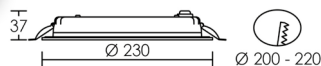

◀100° ○3000 K/○4000 K **50 000 h**

| P (w)       | Lumens | Couleur | Code         | € HT         |
|-------------|--------|---------|--------------|--------------|
| <b>N</b> 28 | 3400   | blanc   | <b>50744</b> | <b>62,00</b> |

**Dimmable par coupure de fin de phase.**  
Données de la LED en 4000 K.

| h (m) | E <sub>max</sub> (lx) | d (m) |
|-------|-----------------------|-------|
| 1     | <b>1286</b>           | 2,38  |
| 2     | <b>322</b>            | 4,8   |
| 3     | <b>143</b>            | 7,2   |

FLAT



Jusqu'à  
**2500 lm**



Corps aluminium/Diffuseur PMMA opale. Fixe. Alimentation séparée pré-câblée, classe 2, IP20.



Version NON DIMMABLE

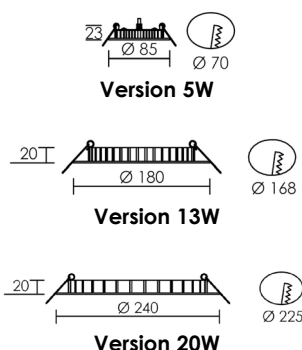

| ◀ 110° |        | 35 000 h |              |              |  |
|--------|--------|----------|--------------|--------------|--|
| P (w)  | Lumens | Teinte   | Code         | € HT         |  |
| 5      | 400    | ● 3000 K | <b>50459</b> | <b>17,50</b> |  |
| 5      | 450    | ○ 4000 K | <b>50359</b> | <b>17,50</b> |  |
| 13     | 840    | ● 3000 K | <b>50104</b> | <b>33,20</b> |  |
| 13     | 980    | ○ 4000 K | <b>50081</b> | <b>33,20</b> |  |
| 20     | 1550   | ● 3000 K | <b>50105</b> | <b>37,40</b> |  |
| 20     | 1700   | ○ 4000 K | <b>50082</b> | <b>37,40</b> |  |

Version DIMMABLE

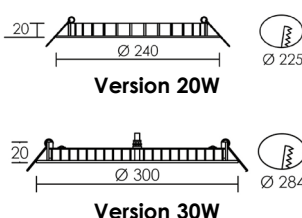

| ◀ 110° |        | 35 000 h |              |              |  |
|--------|--------|----------|--------------|--------------|--|
| P (w)  | Lumens | Teinte   | Code         | € HT         |  |
| 20     | 1700   | ○ 4000 K | <b>50379</b> | <b>66,70</b> |  |
| 30     | 2500   | ○ 4000 K | <b>50380</b> | <b>80,00</b> |  |

Dimmable par coupure de phase.

CÔNES GAMME FLAT

| Code  | Température de couleur | Puissance | Angle | h (m) | E <sub>max</sub> (lx) | d (m) |
|-------|------------------------|-----------|-------|-------|-----------------------|-------|
| 50459 | 3000K                  | 5 W       | 110°  | 1     | 139                   | 2,86  |
|       |                        |           |       | 2     | 35                    | 5,7   |
|       |                        |           |       | 2,5   | 22                    | 7,1   |
| 50104 | 3000k                  | 12 W      | 110°  | 1     | 334                   | 2,86  |
|       |                        |           |       | 2     | 84                    | 5,71  |
|       |                        |           |       | 3     | 37                    | 8,57  |
| 50105 | 3000k                  | 20 W      | 110°  | 1     | 572                   | 2,86  |
|       |                        |           |       | 2     | 143                   | 5,71  |
|       |                        |           |       | 3     | 64                    | 8,57  |
| 50359 | 4000K                  | 5 W       | 110°  | 1     | 156                   | 2,86  |
|       |                        |           |       | 2     | 39                    | 5,7   |
|       |                        |           |       | 2,5   | 25                    | 7,1   |
| 50081 | 4000k                  | 12 W      | 110°  | 1     | 355                   | 2,86  |
|       |                        |           |       | 2     | 89                    | 5,71  |
|       |                        |           |       | 3     | 39                    | 8,57  |
| 50082 | 4000k                  | 20 W      | 110°  | 1     | 604                   | 2,86  |
|       |                        |           |       | 2     | 151                   | 5,71  |
|       |                        |           |       | 3     | 67                    | 8,57  |
| 50379 | 4000K                  | 20W       | 110°  | 1     | 691                   | 2,86  |
|       |                        |           |       | 2     | 173                   | 5,71  |
|       |                        |           |       | 2,5   | 111                   | 7,14  |
| 50380 | 4000K                  | 30W       | 110°  | 1     | 996                   | 2,86  |
|       |                        |           |       | 2     | 249                   | 5,71  |
|       |                        |           |       | 2,5   | 159                   | 7,14  |

# FLAT CCT



Jusqu'à  
**1700 lm**



Interrupteur CCT à l'arrière du produit



Version 5W

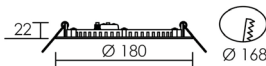

Version 13W



Version 20W

Corps aluminium/Diffuseur PMMA opale. Fixe.  
Alimentation séparée pré-câblée, classe 2, IP20.

|          | ◀110° | ○3000 K/○4000 K |         | 35 000 h     |              |
|----------|-------|-----------------|---------|--------------|--------------|
|          | P (w) | Lumens          | Couleur | Code         | € HT         |
| <b>N</b> | 5     | 450             | blanc   | <b>50801</b> | <b>18,00</b> |
| <b>N</b> | 5     | 450             | nickel  | <b>50802</b> | <b>25,00</b> |
| <b>N</b> | 5     | 450             | noir    | <b>50803</b> | <b>20,00</b> |
| <b>N</b> | 12    | 980             | blanc   | <b>50804</b> | <b>37,00</b> |
| <b>N</b> | 12    | 980             | nickel  | <b>50805</b> | <b>41,00</b> |
| <b>N</b> | 12    | 980             | noir    | <b>50806</b> | <b>38,00</b> |
| <b>N</b> | 20    | 1700            | blanc   | <b>50807</b> | <b>41,00</b> |
| <b>N</b> | 20    | 1700            | nickel  | <b>50808</b> | <b>46,00</b> |
| <b>N</b> | 20    | 1700            | noir    | <b>50809</b> | <b>42,00</b> |

Données de la LED en 4000 K.

## CÔNES GAMME FLAT CCT

| FLAT CCT | 3000K | 5W                    | 110°  |
|----------|-------|-----------------------|-------|
|          | h (m) | E <sub>max</sub> (lx) | d (m) |
|          | 1     | 139                   | 2,86  |
|          | 2     | 35                    | 5,7   |
|          | 3     | 15                    | 8,6   |

| FLAT CCT | 3000K | 12W                   | 110°  |
|----------|-------|-----------------------|-------|
|          | h (m) | E <sub>max</sub> (lx) | d (m) |
|          | 1     | 297                   | 2,86  |
|          | 2     | 74                    | 5,7   |
|          | 3     | 33                    | 8,6   |

| FLAT CCT | 3000K | 20W                   | 110°  |
|----------|-------|-----------------------|-------|
|          | h (m) | E <sub>max</sub> (lx) | d (m) |
|          | 1     | 596                   | 2,86  |
|          | 2     | 149                   | 5,7   |
|          | 3     | 66                    | 8,6   |

| FLAT CCT | 4000K | 5W                    | 110°  |
|----------|-------|-----------------------|-------|
|          | h (m) | E <sub>max</sub> (lx) | d (m) |
|          | 1     | 156                   | 2,86  |
|          | 2     | 39                    | 5,7   |
|          | 3     | 17                    | 8,6   |

| FLAT CCT | 4000K | 12W                   | 110°  |
|----------|-------|-----------------------|-------|
|          | h (m) | E <sub>max</sub> (lx) | d (m) |
|          | 1     | 341                   | 2,86  |
|          | 2     | 85                    | 5,7   |
|          | 3     | 38                    | 8,6   |

| FLAT CCT | 4000K | 20W                   | 110°  |
|----------|-------|-----------------------|-------|
|          | h (m) | E <sub>max</sub> (lx) | d (m) |
|          | 1     | 617                   | 2,86  |
|          | 2     | 154                   | 5,7   |
|          | 3     | 69                    | 8,6   |

UNIVERSAL



Jusqu'à  
**1400 lm**

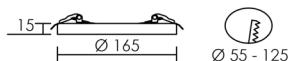
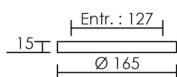

Version 12W

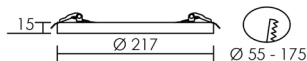
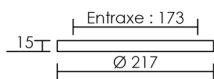

Version 18W

Corps polycarbonate blanc/Diffuseur PMMA. Fixe. Extra-plat : 15 mm. Installation avec fixation encastrable ou saillie. Entraxe réglable. **Alimentation intégrée.** Précâblage 2x 0,5 mm<sup>2</sup>, longueur 20 cm.

○ 3000 K / ○ 4000 K / ○ 6000 K **30 000 h**

| P (w) | Faisceau | Lumens | Code         | € HT         |
|-------|----------|--------|--------------|--------------|
| 12    | 110°     | 1000   | <b>50714</b> | <b>37,70</b> |
| 18    | 110°     | 1400   | <b>50715</b> | <b>52,00</b> |

Dimmable par coupure de phase.  
Données de la LED en 4000 K.

Réglage de la température de couleur  
● 3000 K, ○ 4000 K ou ○ 6000 K  
par interrupteur à l'arrière du spot,  
ou par ON/OFF successifs  
de l'interrupteur de la pièce.  
Fonction mémoire.

| 50714 | 4000K | 12W   | 110°                  |       |
|-------|-------|-------|-----------------------|-------|
|       |       | h (m) | E <sub>max</sub> (lx) | d (m) |
|       |       | 1     | <b>325</b>            | 2,86  |
|       |       | 2     | <b>81</b>             | 5,7   |
|       |       | 3     | <b>36</b>             | 8,6   |

| 50715 | 4000K | 18W   | 110°                  |       |
|-------|-------|-------|-----------------------|-------|
|       |       | h (m) | E <sub>max</sub> (lx) | d (m) |
|       |       | 1     | <b>465</b>            | 2,86  |
|       |       | 2     | <b>116</b>            | 5,7   |
|       |       | 3     | <b>52</b>             | 8,6   |

ACCESSOIRES UNIVERSAL



| Version  | Diamètre | Couleur      | Code         | € HT        |
|----------|----------|--------------|--------------|-------------|
| pour 12W | 166 mm   | nickel satin | <b>50716</b> | <b>6,10</b> |
| pour 12W | 166 mm   | noir         | <b>50717</b> | <b>6,10</b> |
| pour 18W | 219 mm   | nickel satin | <b>50718</b> | <b>7,10</b> |
| pour 18W | 219 mm   | noir         | <b>50719</b> | <b>7,10</b> |



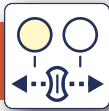

## Gamme UNIVERSAL

### L'encastré modulable

- ✓ Idéal rénovation
- ✓ Installation rapide et facile grâce aux ressorts réglables
- ✓ Extra-plat et alimentation intégrée
- ✓ Température de couleur réglable pour toutes vos utilisations



### Éléments fournis



### Montage applique



Support de fixation pour montage applique

- Version 12W : entraxe 127 mm
- Version 18W : entraxe 173 mm

### Montage encastré

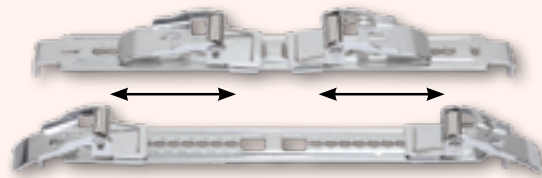

Diamètre d'encastrement réglable

- Version 12W : de 55 mm à 125 mm
- Version 18W : de 55 mm à 175 mm



- Température de couleur réglable**  
(3000 K / 4000 K / 6000 K)
- par interrupteur à l'arrière du spot
  - par ON / OFF successifs de l'interrupteur de la pièce

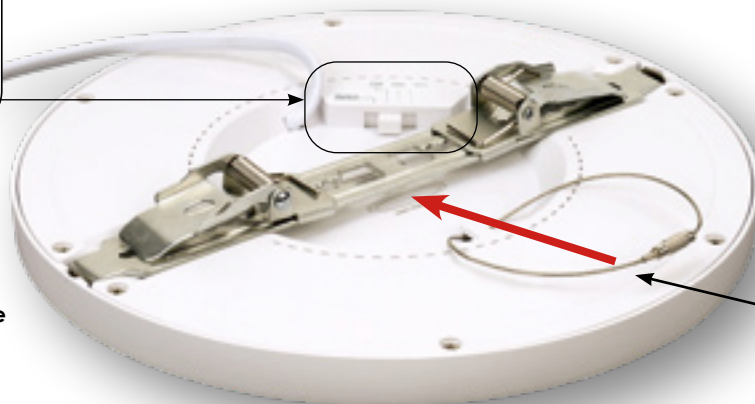

Filin de sécurité prémonté, à lier au support

Fonction mémoire

Collerette décorative aimantée  
(en option)

## RANDY S



680 lm

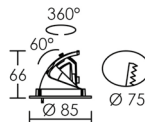

Corps et réflecteur aluminium. Basculant. Blanc.  
Alimentation 350mA, classe 2, IP20. Spot classe 3.

◀ 36° 40 000 h

| P (w) | Lumens | Teinte   | Code         | € HT         |
|-------|--------|----------|--------------|--------------|
| 7,5   | 635    | ● 3000 K | <b>50453</b> | <b>63,20</b> |
| 7,5   | 680    | ○ 4000 K | <b>50443</b> | <b>63,20</b> |

| 50453 | 3000K                 | 10,5W | 30° |
|-------|-----------------------|-------|-----|
| h (m) | E <sub>max</sub> (lx) | d (m) |     |
| 1     | <b>2416</b>           | 0,54  |     |
| 2     | <b>604</b>            | 1,1   |     |
| 3     | <b>268</b>            | 1,6   |     |

| 50443 | 4000K                 | 10,5W | 30° |
|-------|-----------------------|-------|-----|
| h (m) | E <sub>max</sub> (lx) | d (m) |     |
| 1     | <b>2416</b>           | 0,54  |     |
| 2     | <b>604</b>            | 1,1   |     |
| 3     | <b>268</b>            | 1,6   |     |

## RANDY 1



1300 lm

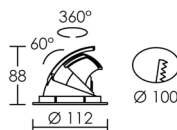

Corps et réflecteur aluminium. Basculant. Blanc.  
Alimentation séparée fournie.

◀ 50° 40 000 h

| P (w) | Lumens | Teinte   | Code         | € HT         |
|-------|--------|----------|--------------|--------------|
| 13    | 1200   | ● 3000 K | <b>50778</b> | <b>93,80</b> |
| 13    | 1300   | ○ 4000 K | <b>50123</b> | <b>93,80</b> |

| 50778 | 3000K                 | 13 W  | 50° |
|-------|-----------------------|-------|-----|
| h (m) | E <sub>max</sub> (lx) | d (m) |     |
| 1     | <b>1864</b>           | 0,93  |     |
| 2     | <b>466</b>            | 1,9   |     |
| 3     | <b>207</b>            | 2,8   |     |

| 50123 | 4000K                 | 13W   | 50° |
|-------|-----------------------|-------|-----|
| h (m) | E <sub>max</sub> (lx) | d (m) |     |
| 1     | <b>1957</b>           | 0,93  |     |
| 2     | <b>489</b>            | 1,9   |     |
| 3     | <b>217</b>            | 2,8   |     |

## RANDY 2



3000 lm

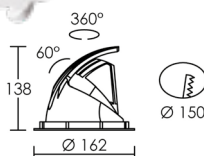

Corps et réflecteur aluminium. Basculant. Blanc.  
Alimentation séparée fournie.

◀ 70° 40 000 h

| P (w) | Lumens | Teinte   | Code         | € HT          |
|-------|--------|----------|--------------|---------------|
| 25,5  | 3000   | ● 3000 K | <b>50191</b> | <b>143,80</b> |
| 25,5  | 3000   | ○ 4000 K | <b>50124</b> | <b>143,80</b> |

| 50191 | 3000K                 | 25,5 W | 70° |
|-------|-----------------------|--------|-----|
| h (m) | E <sub>max</sub> (lx) | d (m)  |     |
| 1     | <b>2667</b>           | 1,40   |     |
| 2     | <b>667</b>            | 2,8    |     |
| 3     | <b>296</b>            | 4,2    |     |

| 50124 | 4000K                 | 25,5 W | 70° |
|-------|-----------------------|--------|-----|
| h (m) | E <sub>max</sub> (lx) | d (m)  |     |
| 1     | <b>2667</b>           | 1,40   |     |
| 2     | <b>667</b>            | 2,8    |     |
| 3     | <b>296</b>            | 4,2    |     |

## RANDY 3



3800 lm

Corps et réflecteur aluminium. Basculant. Blanc.  
Alimentation séparée fournie.



| 70°   |        | 35 000 h |       |        |
|-------|--------|----------|-------|--------|
| P (w) | Lumens | Teinte   | Code  | € HT   |
| 34    | 3600   | 3000 K   | 50192 | 163,20 |
| 34    | 3800   | 4000 K   | 50125 | 163,20 |

| 50192 | 3000K                 | 34 W  | 70° |
|-------|-----------------------|-------|-----|
| h (m) | E <sub>max</sub> (lx) | d (m) |     |
| 1     | 2187                  | 1,40  |     |
| 2     | 547                   | 2,8   |     |
| 3     | 243                   | 4,2   |     |

| 50125 | 4000K                 | 34 W  | 70° |
|-------|-----------------------|-------|-----|
| h (m) | E <sub>max</sub> (lx) | d (m) |     |
| 1     | 2309                  | 1,40  |     |
| 2     | 577                   | 2,8   |     |
| 3     | 257                   | 4,2   |     |

## RANDY 4



4000 lm

Corps et réflecteur aluminium. Basculant. Blanc.  
Alimentation séparée fournie.



| 70°   |        | 30 000 h |       |        |
|-------|--------|----------|-------|--------|
| P (w) | Lumens | Teinte   | Code  | € HT   |
| 38    | 3900   | 3000 K   | 50194 | 180,50 |
| 38    | 4000   | 4000 K   | 50193 | 180,50 |

| 50194 | 3000 K                | 38 W  | 70° |
|-------|-----------------------|-------|-----|
| h (m) | E <sub>max</sub> (lx) | d (m) |     |
| 1     | 3062                  | 1,40  |     |
| 2     | 766                   | 2,8   |     |
| 3     | 340                   | 4,2   |     |

| 50193 | 4000 K                | 38 W  | 70° |
|-------|-----------------------|-------|-----|
| h (m) | E <sub>max</sub> (lx) | d (m) |     |
| 1     | 3141                  | 1,40  |     |
| 2     | 785                   | 2,8   |     |
| 3     | 349                   | 4,2   |     |



## Aide à la pose

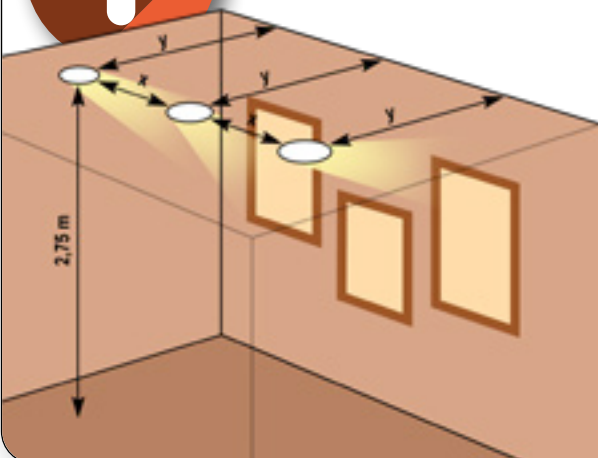

- ✓ RANDY 4 - 4000 K - réf : 50193
- ✓ Hauteur de l'encasté et du mur éclairé 2,75 m
- ✓ Implantation pour un éclairage vertical de 800 lux moyens atteints sur la hauteur totale du mur (2,75 m)

| y : Distance du mur (m) | Inclinaison* | x : Espacement (m) entre deux RANDY |
|-------------------------|--------------|-------------------------------------|
| 1                       | 45°          | 1,5                                 |
| 2                       | 50°          | 1,25                                |
| 2                       | 60°          | 1,35                                |
| 3                       | 60°          | 1                                   |
| 4                       | 60°          | 0,9                                 |

\*Inclinaison 0° de l'encasté → à l'horizontal affleurant le plafond

# MÉTHODES DE CALCUL

## Éclairage des halls, accueils - Grande hauteur > 4 m

### En fonction de :

- la puissance et l'éclairage souhaités ;
- les coefficients de réflexion des parois : 70/50/20% ;
- la hauteur 4 à 5 m.

Ces calculs ne constituent pas un engagement contractuel.

| Gammes en 4000 K  |                                  | Puissance | Page | Nbre d'appareils/m <sup>2</sup> pour 100 lux à 4 m | Nbre d'appareils/m <sup>2</sup> pour 100 lux à 5 m |
|---|----------------------------------|-----------|------|--|--|
|    | DALLE LED PREMIUM                | 40W       | 43   | 0,036  | 0,041  |
|   | DALLE LED BKL PREMIUM 600 x 600  | 40W       | 44   | 0,038  | 0,042  |
|   | DALLE LED BKL                    | 40W       | 45   | 0,042  | 0,05   |
|   | DALLE LED BKL PREMIUM 300 x 1200 | 40W       | 44   | 0,038  | 0,042  |
|  | LEDIUM                           | 30W       | 46   | 0,083  | 0,1  |
|  | IVARO                            | 34W       | 49   | 0,034  | 0,04   |
|  | RIVA                             | 28W       | 52   | 0,049  | 0,062  |
|  | START CCT 230                    | 28W       | 53   | 0,042  | 0,05   |
|  | RANDY                            | 32W       | 59   | 0,04   | 0,05   |
|   |                                  | 38W       | 59   | 0,031  | 0,04   |

**Exemple :** hall de 50 m<sup>2</sup> et de 5 m de hauteur sous plafond, avec LEDIUM 30W, 4000 K.  
Surface 50 m<sup>2</sup> x 0.1 = 5 appareils pour un niveau d'éclairage de 100 lux.

## METROPOLIS LED 45W



4100 lm



Corps et réflecteur aluminium blanc/Verre clair.  
Basculant. Circuit LED SMD. **Alimentation séparée, classe 2, IP20, fournie.**

| ◀ 80° |        | 30 000 h |              |               |
|-------|--------|----------|--------------|---------------|
| P (W) | Lumens | Teinte   | Code         | € HT          |
| 45    | 4100   | ○ 4200 K | <b>50181</b> | <b>193,80</b> |

Alimentation de rechange, code **0052**.

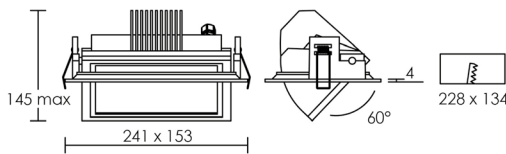

| 50181 | 4200 K                | 45 W  | 80° |
|-------|-----------------------|-------|-----|
| h (m) | E <sub>max</sub> (lx) | d (m) |     |
| 1     | <b>2429</b>           | 1,68  |     |
| 2     | <b>607</b>            | 3,4   |     |
| 3     | <b>270</b>            | 5,0   |     |

## METROPOLIS LED 30W



2500 lm



Corps et réflecteur aluminium blanc/Verre clair.  
Basculant. Circuit LED SMD. **Alimentation séparée, classe 2, IP20, fournie.**

| ◀ 70° |        | 30 000 h |              |               |
|-------|--------|----------|--------------|---------------|
| P (W) | Lumens | Teinte   | Code         | € HT          |
| 30    | 2500   | ○ 4200 K | <b>50087</b> | <b>155,00</b> |

Alimentation de rechange, code **0055**.

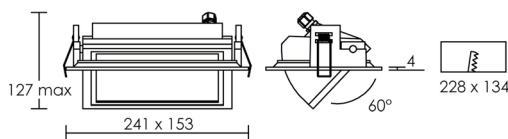

| 50087 | 4200 K                | 30 W  | 70° |
|-------|-----------------------|-------|-----|
| h (m) | E <sub>max</sub> (lx) | d (m) |     |
| 1     | <b>1765</b>           | 1,40  |     |
| 2     | <b>441</b>            | 2,8   |     |
| 3     | <b>196</b>            | 4,2   |     |

QUADRA LED



Corps et support acier/Réflecteur aluminium à facettes. Verre de protection. Double orientation.  
**Module LED avec alimentation séparée fournie.**

Kit MONO

3400 lm

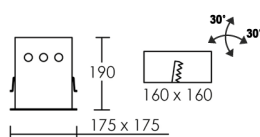

34W ◁40° 40 000 h

| Lumens | Teinte | Couleur | Code  | € HT   |
|--------|--------|---------|-------|--------|
| 3300   | 3000 K | blanc   | 50470 | 176,50 |
| 3400   | 4000 K | blanc   | 50471 | 176,50 |
| 3300   | 3000 K | gris    | 50472 | 176,50 |
| 3400   | 4000 K | gris    | 50473 | 176,50 |

Kit DUO

6800 lm

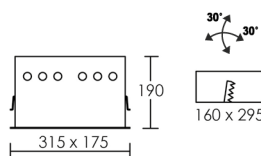

2x 34W ◁40° 40 000 h

| Lumens | Teinte | Couleur | Code  | € HT   |
|--------|--------|---------|-------|--------|
| 6600   | 3000 K | blanc   | 50474 | 330,50 |
| 6800   | 4000 K | blanc   | 50475 | 330,50 |
| 6600   | 3000 K | gris    | 50476 | 330,50 |
| 6800   | 4000 K | gris    | 50477 | 330,50 |

Kit TERTIO

10200 lm

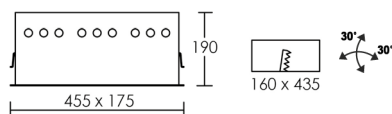

3x 34W ◁40° 40 000 h

| Lumens | Teinte | Couleur | Code  | € HT   |
|--------|--------|---------|-------|--------|
| 9900   | 3000 K | blanc   | 51178 | 496,50 |
| 10200  | 4000 K | blanc   | 51179 | 496,50 |
| 9900   | 3000 K | gris    | 51180 | 496,50 |
| 10200  | 4000 K | gris    | 51181 | 496,50 |

Kit QUATRO

13600 lm

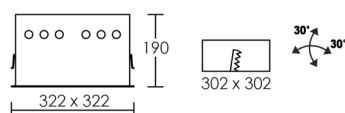

4x 34W ◁40° 40 000 h

| Lumens | Teinte | Couleur | Code  | € HT   |
|--------|--------|---------|-------|--------|
| 13200  | 3000 K | blanc   | 51182 | 664,50 |
| 13600  | 4000 K | blanc   | 51183 | 664,50 |
| 13200  | 3000 K | gris    | 51184 | 664,50 |
| 13600  | 4000 K | gris    | 51185 | 664,50 |

# QUADRA à composer



## Module LED intégrée



3400 lm



Module LED avec alimentation 900 mA séparée fournie.

| Lumens | Teinte | Couleur | Code  | € HT   |
|--------|--------|---------|-------|--------|
| 3300   | 3000 K | noir    | 50480 | 149,90 |
| 3400   | 4000 K | noir    | 50481 | 149,90 |

| QUADRA LED | 3000K                 | 34 W  | 40° |
|------------|-----------------------|-------|-----|
| h (m)      | E <sub>max</sub> (lx) | d (m) |     |
| 1          | 7632                  | 0,73  |     |
| 2          | 1908                  | 1,5   |     |
| 3          | 848                   | 2,2   |     |
| 4          | 477                   | 2,9   |     |
| 5          | 305                   | 3,6   |     |

| QUADRA LED | 4000K                 | 34 W  | 40° |
|------------|-----------------------|-------|-----|
| h (m)      | E <sub>max</sub> (lx) | d (m) |     |
| 1          | 7863                  | 0,73  |     |
| 2          | 1966                  | 1,5   |     |
| 3          | 874                   | 2,2   |     |
| 4          | 491                   | 2,9   |     |
| 5          | 315                   | 3,6   |     |

## Module à lampe séparée



Support avec réflecteur pour lampe iodures.

| P (W) | Douille | Couleur | Code sans lampe | € HT  |
|-------|---------|---------|-----------------|-------|
| 70    | G12     | blanc   | 4273            | 37,50 |
| 70    | G12     | gris    | 4274            | 37,50 |



Support pour lampe AR111.

| P (W) | Douille | Couleur | Code sans lampe | € HT  |
|-------|---------|---------|-----------------|-------|
| 50    | G53     | blanc   | 4196            | 22,30 |
| 50    | G53     | gris    | 4197            | 22,30 |

## Corps QUADRA



| Nb spot | Couleur | Code | € HT  |
|---------|---------|------|-------|
| 1       | blanc   | 4240 | 25,50 |
| 1       | gris    | 4241 | 25,50 |

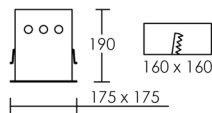

| Nb spots | Couleur | Code | € HT  |
|----------|---------|------|-------|
| 2        | blanc   | 4242 | 36,10 |
| 2        | gris    | 4243 | 36,10 |

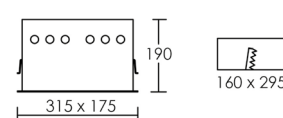

| Nb spots | Couleur | Code | € HT  |
|----------|---------|------|-------|
| 3        | blanc   | 4244 | 46,70 |
| 3        | gris    | 4245 | 46,70 |

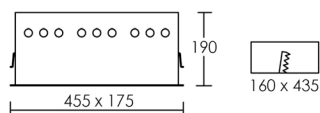

| Nb spots | Couleur | Code | € HT  |
|----------|---------|------|-------|
| 4        | blanc   | 4246 | 64,70 |
| 4        | gris    | 4247 | 64,70 |

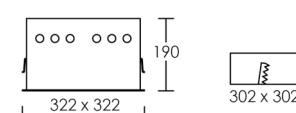













# MÉTHODES DE CALCUL

## Éclairage des circulations - 100 lux moyen au sol

### En fonction de :

- la puissance et l'éclairage souhaités ;
- les coefficients de réflexion des parois : 70/50/20% ;
- la hauteur 2,40 à 2,60 m, largeur 1,50 m.

En aucun cas ces calculs ne constituent un engagement contractuel.

| Luminaire   |               | Teinte   | Puissance                   | Interdistance maxi. entre appareils pour 100 lux moyen dépréciés au sol | Consommation en W/m <sup>2</sup> /100 lux |       |                             |      |
|---|---------------|----------|-----------------------------|---|---|-------|-----------------------------|------|
|    | START CCT 120 | p. 53    | CCT                         | 12W   | 3,1 m                                     | 2,57  |                             |      |
|    | ASPEN         | p. 81    | CCT                         | 5W  | 1,8 m                                     | 2,04  |                             |      |
|    | AIR BLOCK 2   | p. 71    | ○ 4000 K                    | 6W  | 2,1 m                                     | 2,03  |                             |      |
|    | LOKI          | p. 75    | CCT                         | 8W  | 2 m                                       | 2,63  |                             |      |
|    | FLAT CCT      | p. 55    | CCT                         | 13W   | 2,6 m                                     | 3,04  |                             |      |
|   |               |          |                             | 20W   | 3,9 m                                     | 3,75  |                             |      |
|    | GALAXY        | p. 100   | ○ 2700 K<br>○ 4000 K        | 6W  | 1,87 m                                    | 1,97  |                             |      |
|   |               |          |                             |   | ○ 2700 K<br>○ 4000 K                      | 8W    | 1,87 m                      | 1,97 |
|   |               |          | ○ 2700 K<br>○ 4000 K        | 8W  |   |       | 2,50 m                      | 2,09 |
|   |               |          |                             |   | ○ 2700 K<br>○ 4000 K                      | 8W    | 3 m                         | 1,82 |
|  | FLAT          | p. 54    | ○ 3000 K<br>○ 4000 K        | 13W   |   |       | 1,75 m                      | 4,34 |
|   |               |          |                             |   | ○ 3000 K<br>○ 4000 K                      | 20W   | 2 m                         | 3,83 |
|   |               |          | ○ 3000 K<br>○ 4000 K        | 20W   |   |       | 3,75 m                      | 3,62 |
|   |               |          |                             |   | ○ 3000 K<br>○ 4000 K                      | 20W   | 4,2 m                       | 3,31 |
|  | LEDIUM        | p. 46    | ○ 4000 K<br>○ 3000 K        | 10W   |   |       | 1,85 m                      | 3,36 |
|   |               |          |                             |   | ○ 4000 K<br>○ 3000 K                      | 15W   | 2,95 m                      | 3,44 |
|   |               |          | ○ 4000 K<br>○ 3000 K        | 20W   |   |       | 3 m                         | 3,30 |
|   |               |          |                             |   | ○ 4000 K<br>○ 3000 K                      | 20W   | 3,75 m                      | 3,34 |
|   |               |          | ○ 4000 K<br>○ 3000 K        | 20W   |   |       | 4,10 m                      | 3,2  |
|  | ELODY 2       | p. 86    |                             |   | ○ 3000 K<br>○ 4000 K                      | 6W    | 2 m                         | 2    |
|   |               |          | ○ 3000 K<br>○ 4000 K        | 10W   |   |       | 2,20 m                      | 1,82 |
|  | RIVA          | p. 52    |                             |   | ○ 3000 K<br>○ 4000 K                      | 10W   | 3,75 m                      | 1,67 |
|   |               |          | ○ 3000 K<br>○ 4000 K        | 10W   |   |       | 3,75 m                      | 1,61 |
|  | UNIVERSAL     | p. 56    |                             |   | CCT                                       | 12W   | 2,5 m                       | 3,38 |
|   |               |          | CCT                         | 18W   |   | 3,5 m | 3,63                        |      |
|  | FLAT-ISO      | p. 47    |                             |   | CCT                                       | 13W   | 2,7 m                       | 3,2  |
|   |               |          | CCT                         | 20W   |   | 4,3 m | 3,1                         |      |
|  | EF7           | p. 70    |                             |   | ○ 3000 K<br>○ 4000 K<br>CCT               | 7W    | 2,5 m                       | 1,95 |
|   |               |          | ○ 3000 K<br>○ 4000 K<br>CCT | 7W  |   |       | 2,6 m                       | 1,87 |
|   |               |          |                             |   |   |       | ○ 3000 K<br>○ 4000 K<br>CCT | 7W   |
|  | EF6           | p. 68-69 | ○ 3000 K<br>○ 4000 K<br>CCT | 6W  | 2,5 m                                     | 1,60  |                             |      |
|   |               |          |                             |   | ○ 3000 K<br>○ 4000 K<br>CCT               | 6W    | 2,55 m                      | 1,57 |
|   |               |          |                             |   |   |       | ○ 3000 K<br>○ 4000 K<br>CCT | 7W   |



















# MÉTHODES DE CALCUL

## Éclairage des bureaux - 0,80 m du sol

### En fonction de :

- la puissance et l'éclairage souhaités ;
- les coefficients de réflexion des parois : 70/50/20% ;
- la hauteur 2,5 à 2,75 m.

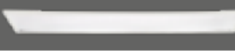
Ces calculs ne constituent pas un engagement contractuel.

| Gammes en 4000 K  | Puissance    | Page | Nbre d'appareils/m <sup>2</sup> pour 300 lux | Nbre d'appareils/m <sup>2</sup> pour 500 lux |
|---|--------------|------|--|--|
|    | 24W          | 53   | 0,14   | 0,22   |
|   | 28W          |      | 0,11   | 0,17   |
|    | 20W          | 55   | 0,2  | 0,34   |
|    | 13W          | 54   | 0,45   | 0,75   |
|   | 20W          |      | 0,24   | 0,38   |
|   | 30W          |      | 0,15   | 0,25   |
|    | 27W          | 52   | 0,13   | 0,21   |
|    | 12W          | 51   | 0,37   | 0,62   |
|   | 17W          |      | 0,25   | 0,4  |
|    | 14W          | 48   | 0,3  | 0,5  |
|   | 20W          |      | 0,2  | 0,35   |
|   | 28W          |      | 0,16   | 0,28   |
|  | 34W          | 49   | 0,08   | 0,14   |
|  | 10W          | 46   | 0,46   | 0,77   |
|   | 15W          |      | 0,3  | 0,51   |
|   | 20W          |      | 0,23   | 0,4  |
|   | 25W          |      | 0,18   | 0,31   |
|   | 30W          |      | 0,15   | 0,25   |
|  | 25W          | 58   | 0,1  | 0,15   |
|   | 32W          |      | 0,1  | 0,15   |
|   | 49W          |      | 0,075  | 0,125  |
|  | 10W          | 52   | 0,31   | 0,52   |
|   | 28W          |      | 0,11   | 0,19   |
|  | 12W          | 56   | 0,33   | 0,56   |
|   | 18W          |      | 0,23   | 0,39   |
|  | 13W          | 47   | 0,34   | 0,52   |
|   | 20W          |      | 0,2  | 0,32   |
|  | 40W - 3000 K | 43   | 0,09   | 0,16   |
|   | 40W - 4000 K |      | 0,083  | 0,14   |
|  | 40W - 4000 K | 44   | 0,10   | 0,16   |
|  | 40W - 4000 K | 44   | 0,10   | 0,16   |
|  | 40W - 4000 K | 45   | 0,11   | 0,19   |

**Exemple :** bureau de 21 m<sup>2</sup> avec modèle FLAT 20, 3000 K.

Surface 21 m<sup>2</sup> x 0,24 = 5 appareils pour un niveau d'éclairage de 300 lux.

## DLT-ISO 75

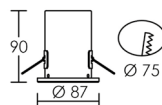

Corps aluminium. Fixe. Enveloppe isolante avec joint d'étanchéité.

| P (w) | Douille | Couleur | Code sans lampe | € HT         |
|-------|---------|---------|-----------------|--------------|
| 6     | GU10    | blanc   | <b>50733</b>    | <b>14,60</b> |
| 6     | GU10    | nickel  | <b>50734</b>    | <b>15,80</b> |



ADAPTÉ POUR LAMPES LED  
Puissance maxi. = 6W



## DLT-ISO 90

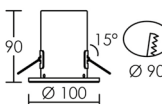

Corps aluminium. Basculant à 15°. Enveloppe isolante avec joint d'étanchéité.

| P (w) | Douille | Couleur | Code sans lampe | € HT         |
|-------|---------|---------|-----------------|--------------|
| 6     | GU10    | blanc   | <b>50735</b>    | <b>17,20</b> |
| 6     | GU10    | nickel  | <b>50736</b>    | <b>18,40</b> |



ADAPTÉ POUR LAMPES LED  
Puissance maxi. = 6W



DL-ISO IP20



840 lm



Corps en acier noir/Capôt en polycarbonate/  
Réflecteur aluminium à facettes. Basculant.  
**Alimentation 200 mA fournie, séparée (ne pas recouvrir).**

| 8W     |        | 65°     |              | 40 000 h     |  |
|--------|--------|---------|--------------|--------------|--|
| Lumens | Teinte | Couleur | Code         | € HT         |  |
| 800    | 3000 K | blanc   | <b>50631</b> | <b>50,00</b> |  |
| 840    | 4000 K | blanc   | <b>50632</b> | <b>50,00</b> |  |
| 800    | 3000 K | nickel  | <b>50633</b> | <b>53,00</b> |  |
| 840    | 4000 K | nickel  | <b>50634</b> | <b>53,00</b> |  |

Dimmable par coupure de fin de phase.

| 50631 | 3000K                 | 8W    | 65° |
|-------|-----------------------|-------|-----|
| h (m) | E <sub>max</sub> (lx) | d (m) |     |
| 1     | <b>710</b>            | 1,27  |     |
| 2     | <b>178</b>            | 2,5   |     |
| 2,5   | <b>114</b>            | 3,2   |     |

| 50632 | 4000K                 | 8W    | 65° |
|-------|-----------------------|-------|-----|
| h (m) | E <sub>max</sub> (lx) | d (m) |     |
| 1     | <b>746</b>            | 1,27  |     |
| 2     | <b>187</b>            | 2,5   |     |
| 2,5   | <b>119</b>            | 3,2   |     |





EF6 CCT



600 lm



Corps acier noir/Collerette acier blanche. Fixe. Précâblage 3x 0,75 mm<sup>2</sup>, 0,15 m. LED SMD.

○ 3000 K / ○ 4000 K 35 000 h

| P (w) | Faisceau | Lumens | Code  | € HT  |
|-------|----------|--------|-------|-------|
| N 7   | 55°      | 600    | 11005 | 29,00 |

Dimmable par coupure de phase.  
Données de la LED en 4000 K.

Réglage de la température de couleur  
○ 3000 K, ○ 4000 K par interrupteur  
sous la collerette du spot.



Faible hauteur : 57 mm

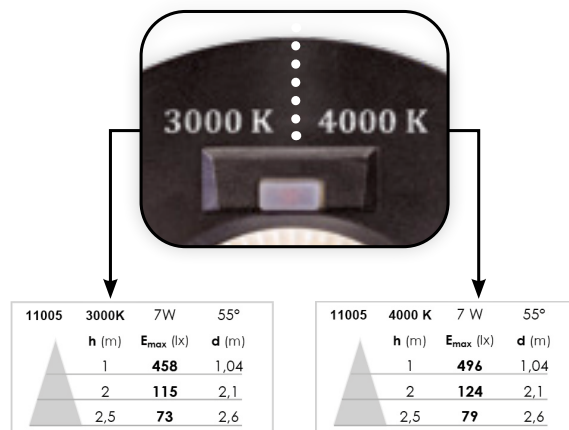
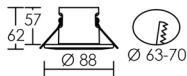

ACCESSOIRES GAMME EF6 & EF6 CCT



Collerettes rondes.

| Couleur | Code  | € HT |
|---------|-------|------|
| nickel  | 11003 | 2,60 |
| doré    | 11006 | 2,60 |
| noir    | 11004 | 2,60 |
| chromé  | 11008 | 3,60 |
| blanc   | 11007 | 2,60 |



Collerettes carrées.

| Couleur | Code  | € HT |
|---------|-------|------|
| nickel  | 11010 | 3,60 |
| doré    | 11012 | 3,60 |
| noir    | 11011 | 3,60 |
| chromé  | 11013 | 3,60 |
| blanc   | 11009 | 3,60 |

## EF7



650 lm

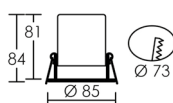

Corps et dissipateur aluminium noir/Diffuseur PMMA/ Réflecteur à facettes/Collerette acier blanc. Fixe. Boîte de connexion intégrée. LED COB. **Alimentation intégrée.**

◀ 50° 50 000 h

| P (w) | Lumens | Teinte   | Code         | € HT         |
|-------|--------|----------|--------------|--------------|
| 7     | 600    | ● 3000 K | <b>50705</b> | <b>30,60</b> |
| 7     | 650    | ○ 4000 K | <b>50706</b> | <b>30,60</b> |

Dimmable par coupure de phase.

| 50705 | 3000K                 | 7W    | 50° |
|-------|-----------------------|-------|-----|
| h (m) | E <sub>max</sub> (lx) | d (m) |     |
| 1     | <b>812</b>            | 0,93  |     |
| 2     | <b>203</b>            | 1,9   |     |
| 2,5   | <b>130</b>            | 2,3   |     |

| 50706 | 4000K                 | 7W    | 50° |
|-------|-----------------------|-------|-----|
| h (m) | E <sub>max</sub> (lx) | d (m) |     |
| 1     | <b>879</b>            | 0,93  |     |
| 2     | <b>220</b>            | 1,9   |     |
| 2,5   | <b>141</b>            | 2,3   |     |

## EF7 CCT



650 lm

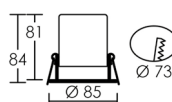

Corps et dissipateur aluminium noir/Lentille PMMA/ Collerette acier blanc. Fixe. Boîte de connexion intégrée. LED SMD. **Alimentation intégrée.**

○ 3000 K / ○ 4000 K 50 000 h

| P (w) | Faisceau | Lumens | Code         | € HT         |
|-------|----------|--------|--------------|--------------|
| 7     | 65°      | 650    | <b>50707</b> | <b>34,70</b> |

Dimmable par coupure de phase.  
Données de la LED en 4000 K.

| 50707 | 4000 K                | 7 W   | 65° |
|-------|-----------------------|-------|-----|
| h (m) | E <sub>max</sub> (lx) | d (m) |     |
| 1     | <b>457</b>            | 1,27  |     |
| 2     | <b>114</b>            | 2,5   |     |
| 2,5   | <b>73</b>             | 3,2   |     |

Réglage de la température de couleur  
● 3000 K, ○ 4000 K par interrupteur  
à l'arrière du spot.

## ACCESSOIRES GAMME EF7



| Couleur      | Code         | € HT        |
|--------------|--------------|-------------|
| nickel satin | <b>50708</b> | <b>3,30</b> |
| noir         | <b>50709</b> | <b>3,30</b> |

# AIR BLOCK 2



460 lm

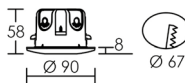

Corps aluminium blanc/Optique en PMMA/Joint d'étanchéité plafond silicone. Livré avec sa boîte d'encastrement étanche à l'air. **Alimentation intégrée.**

|          | P (W) | Lumens | Teinte | Code         | € HT         |
|----------|-------|--------|--------|--------------|--------------|
| <b>N</b> | 6     | 430    | 3000 K | <b>50880</b> | <b>40,00</b> |
| <b>N</b> | 6     | 460    | 4000 K | <b>50881</b> | <b>40,00</b> |

Dimmable par coupure de phase.

| 50880 | 3000K                 | 6W    | 36° |
|-------|-----------------------|-------|-----|
| h (m) | E <sub>max</sub> (lx) | d (m) |     |
| 1     | 958                   | 0,65  |     |
| 2     | 240                   | 1,3   |     |
| 2,5   | 153                   | 1,6   |     |

| 50881 | 4000K                 | 6W    | 36° |
|-------|-----------------------|-------|-----|
| h (m) | E <sub>max</sub> (lx) | d (m) |     |
| 1     | 1025                  | 0,65  |     |
| 2     | 256                   | 1,3   |     |
| 2,5   | 164                   | 1,6   |     |

## ACCESSOIRES GAMME AIR BLOCK 2



| Couleur      | Code         | € HT        |
|--------------|--------------|-------------|
| nickel satin | <b>50882</b> | <b>4,00</b> |
| noir         | <b>50883</b> | <b>5,00</b> |



## Gamme AIR BLOCK 2

✓ Conçue et fabriquée dans nos ateliers



1/ Amenez la gaine électrique dans la boîte étanche.



2/ Fixez la boîte étanche dans le faux plafond. Procédez à la mise en place de l'isolant.

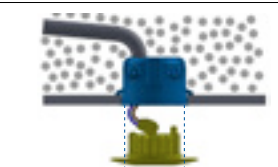

3/ Effectuez le raccordement électrique (230V direct) et vissez le AIR BLOCK sur sa boîte étanche.

**LUMINAIRE ÉTANCHE À L'AIR.**

✓ Boîte étanche à l'air

✓ Peut être recouvert d'isolant soufflé ou en rouleau

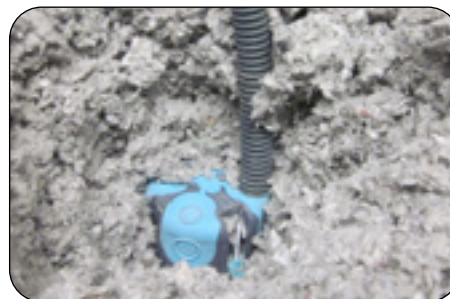

AQUAFLAT



480 lm

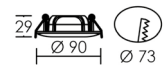

Corps aluminium/Diffuseur polycarbonate opale.  
Alimentation intégrée.

| 6W           | 110°   | 35 000 h |              |              |
|--------------|--------|----------|--------------|--------------|
| Lumens       | Teinte | Couleur  | Code         | € HT         |
| 450          | 3000 K | blanc    | <b>50516</b> | <b>19,40</b> |
| 480          | 4000 K | blanc    | <b>50517</b> | <b>19,40</b> |
| <b>N</b> 450 | 3000 K | nickel   | <b>50790</b> | <b>23,00</b> |
| <b>N</b> 480 | 4000 K | nickel   | <b>50791</b> | <b>23,00</b> |
| <b>N</b> 450 | 3000 K | noir     | <b>50792</b> | <b>19,00</b> |
| <b>N</b> 480 | 4000 K | noir     | <b>50793</b> | <b>19,00</b> |

| 50516 | 3000K                 | 6W    | 110° |
|-------|-----------------------|-------|------|
| h (m) | E <sub>max</sub> (lx) | d (m) |      |
| 1     | 161                   | 2,86  |      |
| 2     | 40                    | 5,7   |      |
| 3     | 18                    | 8,6   |      |

| 50517 | 4000K                 | 6W    | 110° |
|-------|-----------------------|-------|------|
| h (m) | E <sub>max</sub> (lx) | d (m) |      |
| 1     | 173                   | 2,86  |      |
| 2     | 43                    | 5,7   |      |
| 3     | 19                    | 8,6   |      |



AQUAPRO



800 lm



Corps aluminium/Optique à facettes aluminisées.  
Haut confort visuel. **Alimentation intégrée.**



| 8W           | 60°    |         |              |              | 35 000 h |
|--------------|--------|---------|--------------|--------------|----------|
| Lumens       | Teinte | Couleur | Code         | € HT         |          |
| 760          | 3000 K | blanc   | <b>50410</b> | <b>35,40</b> |          |
| 800          | 4000 K | blanc   | <b>50411</b> | <b>35,40</b> |          |
| <b>N</b> 760 | 3000 K | nickel  | <b>50794</b> | <b>39,00</b> |          |
| <b>N</b> 800 | 4000 K | nickel  | <b>50795</b> | <b>39,00</b> |          |
| <b>N</b> 760 | 3000 K | noir    | <b>50796</b> | <b>35,00</b> |          |
| <b>N</b> 800 | 4000 K | noir    | <b>50797</b> | <b>35,00</b> |          |

| 50410 | 3000K | 8W                    | 60°   |
|-------|-------|-----------------------|-------|
|       | h (m) | E <sub>max</sub> (lx) | d (m) |
|       | 1     | 847                   | 1,15  |
|       | 2     | 212                   | 2,3   |
|       | 2,5   | 136                   | 2,9   |

| 50411 | 4000K | 8W                    | 60°   |
|-------|-------|-----------------------|-------|
|       | h (m) | E <sub>max</sub> (lx) | d (m) |
|       | 1     | 892                   | 1,15  |
|       | 2     | 223                   | 2,3   |
|       | 2,5   | 143                   | 2,9   |

## AXEL basculant CCT



550 lm



Corps polycarbonate injecté/Colerette aluminium. Basculant. LED SMD. **Alimentation intégrée.**

◁ 60° ○ 3000 K / ○ 4000 K **35 000 h**

| P (w) | Lumens | Couleur      | Code         | € HT         |
|-------|--------|--------------|--------------|--------------|
| 6     | 550    | blanc        | <b>50724</b> | <b>38,80</b> |
| 6     | 550    | nickel satin | <b>50725</b> | <b>42,80</b> |
| 6     | 550    | noir         | <b>50726</b> | <b>38,80</b> |

Données de la LED en 4000 K.

| 50724 | 4000K                 | 6 W   | 60° |
|-------|-----------------------|-------|-----|
| h (m) | E <sub>max</sub> (lx) | d (m) |     |
| 1     | <b>544</b>            | 1,15  |     |
| 2     | <b>136</b>            | 2,3   |     |
| 2,5   | <b>87</b>             | 2,9   |     |

Réglage de la température de couleur  
○ 3000 K ou ○ 4000 K  
par interrupteur à l'arrière du spot.

## AXEL fixe



550 lm



Corps polycarbonate injecté/Colerette aluminium. Fixe, blanc. LED SMD. **Alimentation intégrée.**

◁ 60° **35 000 h**

| P (w) | Lumens | Teinte   | Code         | € HT         |
|-------|--------|----------|--------------|--------------|
| 6     | 500    | ○ 3000 K | <b>50720</b> | <b>29,60</b> |
| 6     | 550    | ○ 4000 K | <b>50721</b> | <b>29,60</b> |

| 50720 | 3000K                 | 6W    | 60° |
|-------|-----------------------|-------|-----|
| h (m) | E <sub>max</sub> (lx) | d (m) |     |
| 1     | <b>494</b>            | 1,15  |     |
| 2     | <b>124</b>            | 2,3   |     |
| 2,5   | <b>79</b>             | 2,9   |     |

| 50721 | 4000K                 | 6W    | 60° |
|-------|-----------------------|-------|-----|
| h (m) | E <sub>max</sub> (lx) | d (m) |     |
| 1     | <b>544</b>            | 1,15  |     |
| 2     | <b>136</b>            | 2,3   |     |
| 2,5   | <b>87</b>             | 2,9   |     |

## ACCESSOIRES AXEL (fixe uniquement)



| Couleur      | Code         | € HT        |
|--------------|--------------|-------------|
| nickel satin | <b>50722</b> | <b>2,70</b> |
| noir         | <b>50723</b> | <b>2,70</b> |

LOKI



Jusqu'à  
**800 lm**

Corps polycarbonate/Diffuseur opale. Alimentation intégrée.

Version 6W



|            |                     |          |              |              |
|------------|---------------------|----------|--------------|--------------|
| ◁ 100°     | ● 3000 K / ○ 4000 K | 20 000 h |              |              |
| P (W)      | Lumens              | Couleur  | Code         | € HT         |
| <b>N</b> 6 | 600                 | blanc    | <b>50951</b> | <b>23,00</b> |

**Dimmable par coupure de phase.**  
Données de la LED en 4000 K.

|       |                       |       |      |
|-------|-----------------------|-------|------|
| 50951 | 4000K                 | 6W    | 100° |
| h (m) | E <sub>max</sub> (lx) | d (m) |      |
| 1     | 233                   | 2,38  |      |
| 2     | 58                    | 4,8   |      |
| 3     | 26                    | 7,2   |      |

Réglage de la température de couleur  
● 3000 K ou ○ 4000 K  
par interrupteur à l'arrière du spot.

Version 8W



|            |                     |          |              |              |
|------------|---------------------|----------|--------------|--------------|
| ◁ 100°     | ● 3000 K / ○ 4000 K | 20 000 h |              |              |
| P (W)      | Lumens              | Couleur  | Code         | € HT         |
| <b>N</b> 8 | 800                 | blanc    | <b>50952</b> | <b>25,00</b> |

**Dimmable par coupure de phase.**  
Données de la LED en 4000 K.

|       |                       |       |      |
|-------|-----------------------|-------|------|
| 50952 | 4000K                 | 8W    | 100° |
| h (m) | E <sub>max</sub> (lx) | d (m) |      |
| 1     | 302                   | 2,38  |      |
| 2     | 76                    | 4,8   |      |
| 3     | 34                    | 7,2   |      |

Réglage de la température de couleur  
● 3000 K ou ○ 4000 K  
par interrupteur à l'arrière du spot.

## DL-ISO IP65



820 lm



Corps en acier blanc/Capot en polycarbonate/  
Réflecteur aluminium à facettes. Joint d'étanchéité.  
Fixe. **Alimentation 200 mA fournie, séparée (ne pas recouvrir).**

8W ◀ 50° 40 000 h

| Lumens | Teinte | Couleur | Code         | € HT         |
|--------|--------|---------|--------------|--------------|
| 770    | 3000 K | blanc   | <b>50652</b> | <b>47,90</b> |
| 820    | 4000 K | blanc   | <b>50653</b> | <b>47,90</b> |
| 770    | 3000 K | nickel  | <b>50654</b> | <b>50,00</b> |
| 820    | 4000 K | nickel  | <b>50655</b> | <b>50,00</b> |

Dimmable par coupure de fin de phase.

| 50652 | 3000K                 | 8W    | 50° |
|-------|-----------------------|-------|-----|
| h (m) | E <sub>max</sub> (lx) | d (m) |     |
| 1     | <b>896</b>            | 0,93  |     |
| 2     | <b>224</b>            | 1,9   |     |
| 2,5   | <b>143</b>            | 2,3   |     |

| 50653 | 4000K                 | 8W    | 50° |
|-------|-----------------------|-------|-----|
| h (m) | E <sub>max</sub> (lx) | d (m) |     |
| 1     | <b>959</b>            | 0,93  |     |
| 2     | <b>240</b>            | 1,9   |     |
| 2,5   | <b>153</b>            | 2,3   |     |

## P10



830 lm



Corps aluminium/Diffuseur opale. Fixe. **Spot classe 3.**  
**Alimentation 350 mA, classe 2, IP20 (ne pas recouvrir).**

10W ◀ 90° 35 000 h

| Lumens | Teinte | Couleur | Code         | € HT         |
|--------|--------|---------|--------------|--------------|
| 800    | 3000 K | blanc   | <b>50538</b> | <b>22,40</b> |
| 830    | 4000 K | blanc   | <b>50539</b> | <b>22,40</b> |
| 800    | 3000 K | nickel  | <b>50540</b> | <b>23,50</b> |
| 830    | 4000 K | nickel  | <b>50541</b> | <b>23,50</b> |

Dimmable par coupure de phase.

| 50538 | 3000 K                | 10W   | 90° |
|-------|-----------------------|-------|-----|
| h (m) | E <sub>max</sub> (lx) | d (m) |     |
| 1     | <b>357</b>            | 2,00  |     |
| 2     | <b>89</b>             | 4,0   |     |
| 3     | <b>40</b>             | 6,0   |     |

| 50539 | 4000 K                | 10W   | 90° |
|-------|-----------------------|-------|-----|
| h (m) | E <sub>max</sub> (lx) | d (m) |     |
| 1     | <b>370</b>            | 2,00  |     |
| 2     | <b>93</b>             | 4,0   |     |
| 3     | <b>41</b>             | 6,0   |     |

DL 084



680 lm



Corps en aluminium et polycarbonate/Réflecteur aluminium à facettes. Orientable +/- 30° sur 360°. Alimentation 200 mA fournie, séparée (ne pas recouvrir).

| 8W     |        | 47°     |       | 40 000 h |  |
|--------|--------|---------|-------|----------|--|
| Lumens | Teinte | Couleur | Code  | € HT     |  |
| 630    | 3000 K | blanc   | 50635 | 46,90    |  |
| 680    | 4000 K | blanc   | 50636 | 46,90    |  |
| 630    | 3000 K | nickel  | 50637 | 46,90    |  |
| 680    | 4000 K | nickel  | 50638 | 46,90    |  |

Dimmable par coupure de fin de phase.

| 50635 | 3000K                 | 8W    | 47° |
|-------|-----------------------|-------|-----|
| h (m) | E <sub>max</sub> (lx) | d (m) |     |
| 1     | 786                   | 0,87  |     |
| 2     | 197                   | 1,7   |     |
| 2,5   | 126                   | 2,2   |     |

| 50636 | 4000K                 | 8W    | 47° |
|-------|-----------------------|-------|-----|
| h (m) | E <sub>max</sub> (lx) | d (m) |     |
| 1     | 848                   | 0,87  |     |
| 2     | 212                   | 1,7   |     |
| 2,5   | 136                   | 2,2   |     |

KIT HIDRO 50 XL6



635 lm



Corps aluminium/Verre de protection. Joint d'étanchéité. Hauteur d'encastrement réduite : 45 mm. Spot classe 3. Alimentation 500 mA, classe 2, IP20 (ne pas recouvrir).

| 6W     |        | 40°     |       | 35 000 h |  |
|--------|--------|---------|-------|----------|--|
| Lumens | Teinte | Couleur | Code  | € HT     |  |
| 590    | 3000 K | blanc   | 51108 | 52,00    |  |
| 635    | 4000 K | blanc   | 51109 | 52,00    |  |
| 590    | 3000 K | nickel  | 51110 | 53,00    |  |
| 635    | 4000 K | nickel  | 51111 | 53,00    |  |

| XL6   | 3000K                 | 6W    | 40° |
|-------|-----------------------|-------|-----|
| h (m) | E <sub>max</sub> (lx) | d (m) |     |
| 1     | 947                   | 0,73  |     |
| 2     | 237                   | 1,5   |     |
| 2,5   | 152                   | 1,8   |     |

| XL6   | 4000K                 | 6W    | 40° |
|-------|-----------------------|-------|-----|
| h (m) | E <sub>max</sub> (lx) | d (m) |     |
| 1     | 1020                  | 0,73  |     |
| 2     | 255                   | 1,5   |     |
| 2,5   | 163                   | 1,8   |     |

GRACE



Jusqu'à  
**660 lm**

Corps polycarbonate/Dissipateur thermique en aluminium surmoulé.  
Vasque polycarbonate opale. **Alimentation intégrée.**



Version 5W

| 50330 | 3000 K                | 5 W   | 90° |
|-------|-----------------------|-------|-----|
| h (m) | E <sub>max</sub> (lx) | d (m) |     |
| 1     | 219                   | 2,00  |     |
| 2     | 55                    | 4,0   |     |
| 3     | 24                    | 6,0   |     |

| 50332 | 4000 K                | 5W    | 90° |
|-------|-----------------------|-------|-----|
| h (m) | E <sub>max</sub> (lx) | d (m) |     |
| 1     | 229                   | 2,00  |     |
| 2     | 57                    | 4,0   |     |
| 3     | 25                    | 6,0   |     |

| 90°   |        | 30 000 h |              |              |
|-------|--------|----------|--------------|--------------|
| P (W) | Lumens | Teinte   | Code         | € HT         |
| 5     | 440    | ● 3000 K | <b>50330</b> | <b>14,30</b> |
| 5     | 460    | ○ 4000 K | <b>50332</b> | <b>14,30</b> |

Version 7W

| 50331 | 3000 K                | 7 W   | 90° |
|-------|-----------------------|-------|-----|
| h (m) | E <sub>max</sub> (lx) | d (m) |     |
| 1     | 292                   | 2,00  |     |
| 2     | 73                    | 4,0   |     |
| 3     | 32                    | 6,0   |     |

| 50333 | 4000 K                | 7W    | 90° |
|-------|-----------------------|-------|-----|
| h (m) | E <sub>max</sub> (lx) | d (m) |     |
| 1     | 326                   | 2,00  |     |
| 2     | 82                    | 4,0   |     |
| 3     | 36                    | 6,0   |     |

| 90°   |        | 30 000 h |              |              |
|-------|--------|----------|--------------|--------------|
| P (W) | Lumens | Teinte   | Code         | € HT         |
| 7     | 630    | ● 3000 K | <b>50331</b> | <b>20,40</b> |
| 7     | 660    | ○ 4000 K | <b>50333</b> | <b>20,40</b> |

KIT ELITE F4



**1100 lm**

Corps aluminium. Verre de protection. Fixe, blanc.  
Kit prêt-à-poser. LED de puissance. **Alimentation 350 mA, classe 2, IP20. Spot classe 3.**

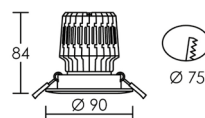

| 13W      |        | 50 000 h |              |              |
|----------|--------|----------|--------------|--------------|
| Faisceau | Lumens | Teinte   | Code         | € HT         |
| 36°      | 1100   | ● 3000 K | <b>50154</b> | <b>70,30</b> |
| 36°      | 1100   | ○ 4000 K | <b>50155</b> | <b>70,30</b> |
| 60°      | 1100   | ● 3000 K | <b>50156</b> | <b>70,30</b> |
| 60°      | 1100   | ○ 4000 K | <b>50157</b> | <b>70,30</b> |

Dimmable par coupure de phase 10 à 100% en 350mA.

| ELITE 13 |        | 13 w  | 36° |
|----------|--------|-------|-----|
| h (m)    | E (lx) | d (m) |     |
| 1        | 2424   | 0,65  |     |
| 2        | 606    | 1,3   |     |
| 3        | 269    | 2,0   |     |

| ELITE 13 |        | 13 w  | 60° |
|----------|--------|-------|-----|
| h (m)    | E (lx) | d (m) |     |
| 1        | 1393   | 1,16  |     |
| 2        | 348    | 2,3   |     |
| 3        | 155    | 3,5   |     |

**AVERY**



700 lm



Corps plastique blanc/Diffuseur polycarbonate opale/  
Dissipateur thermique aluminium. **Alimentation intégrée.**

◀ 90° 30 000 h

| P (w) | Lumens | Teinte   | Code         | € HT         |
|-------|--------|----------|--------------|--------------|
| 7     | 630    | ● 3000 K | <b>50518</b> | <b>15,10</b> |
| 7     | 700    | ○ 4000 K | <b>50519</b> | <b>15,10</b> |

| 50518 | 3000K                 | 7W    | 90° |
|-------|-----------------------|-------|-----|
| h (m) | E <sub>max</sub> (lx) | d (m) |     |
| 1     | <b>284</b>            | 2,00  |     |
| 2     | <b>71</b>             | 4,0   |     |
| 2,5   | <b>45</b>             | 5,0   |     |

| 50519 | 4000K                 | 7W    | 90° |
|-------|-----------------------|-------|-----|
| h (m) | E <sub>max</sub> (lx) | d (m) |     |
| 1     | <b>319</b>            | 2,00  |     |
| 2     | <b>80</b>             | 4,0   |     |
| 2,5   | <b>51</b>             | 5,0   |     |

**ACCESSOIRE AVERY**



| Couleur     | Code        | € HT        |
|-------------|-------------|-------------|
| alu. brossé | <b>0169</b> | <b>2,00</b> |

**BIRDY**



800 lm



Corps thermoplastique. Fixe, blanc. LED SMD.  
**Alimentation intégrée précâblée 0,15 m.**

◀ 110° 40 000 h

| P (w) | Lumens | Teinte   | Code         | € HT         |
|-------|--------|----------|--------------|--------------|
| 9     | 800    | ● 3000 K | <b>50039</b> | <b>33,00</b> |
| 9     | 800    | ○ 4000 K | <b>50040</b> | <b>33,00</b> |

Dimmable par coupure de phase.

| 50039 | 3000K                 | 9W    | 110° |
|-------|-----------------------|-------|------|
| h (m) | E <sub>max</sub> (lx) | d (m) |      |
| 1     | <b>287</b>            | 2,86  |      |
| 2     | <b>72</b>             | 5,7   |      |
| 3     | <b>32</b>             | 8,6   |      |

| 50040 | 4000K                 | 9W    | 110° |
|-------|-----------------------|-------|------|
| h (m) | E <sub>max</sub> (lx) | d (m) |      |
| 1     | <b>287</b>            | 2,86  |      |
| 2     | <b>72</b>             | 5,7   |      |
| 3     | <b>32</b>             | 8,6   |      |

**ACCESSOIRES BIRDY**



| Couleur     | Code         | € HT        |
|-------------|--------------|-------------|
| alu. brossé | <b>50059</b> | <b>8,70</b> |
| chrome      | <b>50061</b> | <b>8,70</b> |

CLASSO

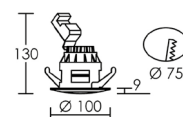

Corps aluminium/Verre sablé et joint d'étanchéité. Fixe.

Sans lampe - Douille GU5,3



| P (w) | Douille | Couleur | Code        | € HT         |
|-------|---------|---------|-------------|--------------|
| 50    | GU5,3   | blanc   | <b>4106</b> | <b>23,50</b> |

Avec lampe LED GU5,3 6W



Kit prêt-à-posser. Alimentation classe 2, IP20. Spot classe 3.

355 lm

| Code  | Température de couleur | Puissance | Angle | h (m) | E <sub>max</sub> (lx) | d (m) |
|-------|------------------------|-----------|-------|-------|-----------------------|-------|
| 50227 | 3000K                  | 7W        | 55°   | 1     | 297                   | 1,04  |
|       |                        |           |       | 2     | 74                    | 2,1   |
|       |                        |           |       | 2,5   | 48                    | 2,6   |
| 4620  | 4000K                  | 7W        | 55°   | 1     | 310                   | 1,04  |
|       |                        |           |       | 2     | 78                    | 2,1   |
|       |                        |           |       | 2,5   | 50                    | 2,6   |

| 6W     | 55°    | 15 000 h |              |              |
|--------|--------|----------|--------------|--------------|
| Lumens | Teinte | Couleur  | Code         | € HT         |
| 340    | 3000 K | blanc    | <b>50227</b> | <b>39,80</b> |
| 355    | 4000 K | blanc    | <b>4620</b>  | <b>39,80</b> |

Avec lampe LED GU5,3 8W



Kit prêt-à-posser. Alimentation classe 2, IP20. Spot classe 3.

520 lm

| Code  | Température de couleur | Puissance | Angle | h (m) | E <sub>max</sub> (lx) | d (m) |
|-------|------------------------|-----------|-------|-------|-----------------------|-------|
| 50211 | 2700K                  | 8W        | 55°   | 1     | 440                   | 1,04  |
|       |                        |           |       | 2     | 110                   | 2,1   |
|       |                        |           |       | 2,5   | 70                    | 2,6   |
| 50212 | 4000K                  | 8W        | 55°   | 1     | 458                   | 1,04  |
|       |                        |           |       | 2     | 115                   | 2,1   |
|       |                        |           |       | 2,5   | 73                    | 2,6   |

| 8W     | 55°    | 15 000 h |              |              |
|--------|--------|----------|--------------|--------------|
| Lumens | Teinte | Couleur  | Code         | € HT         |
| 500    | 2700 K | blanc    | <b>50211</b> | <b>41,80</b> |
| 520    | 4000 K | blanc    | <b>50212</b> | <b>41,80</b> |



## ASPEN



450 lm



Corps en fonderie d'aluminium. Alimentation intégrée.

|          | 36°   | 3000 K / 4000 K |         | 25 000 h     |              |
|----------|-------|-----------------|---------|--------------|--------------|
|          | P (W) | Lumens          | Couleur | Code         | € HT         |
| <b>N</b> | 5     | 450             | blanc   | <b>50747</b> | <b>16,00</b> |
| <b>N</b> | 5     | 450             | nickel  | <b>50748</b> | <b>18,00</b> |
| <b>N</b> | 5     | 450             | noir    | <b>50749</b> | <b>16,60</b> |

Dimmable par coupure de fin de phase.  
Données de la LED en 4000 K.

| ASPEN | 4000K | 5W                    | 36°   |
|-------|-------|-----------------------|-------|
|       | h (m) | E <sub>max</sub> (lx) | d (m) |
|       | 1     | 709                   | 0,65  |
|       | 2     | 177                   | 1,3   |
|       | 3     | 79                    | 1,9   |

Réglage de la température de couleur  
 3000 K ou  4000 K  
 par interrupteur à l'arrière du spot.

## KIT LUCIA XL6



635 lm



Corps aluminium/Colletette polycarbonate. Fixe.  
Kit prêt-à-posier. Précâblage 0,35 m avec connecteur.  
Alimentation 500mA, classe 2, IP20. Spot classe 3.

|  | 6W     | 40°                          |           | 35 000 h        |              |
|--|--------|------------------------------|-----------|-----------------|--------------|
|  | Lumens | Teinte                       | Couleur   | Code avec lampe | € HT         |
|  | 590    | <input type="radio"/> 3000 K | gris alu. | <b>51085</b>    | <b>49,00</b> |
|  | 635    | <input type="radio"/> 4000 K | gris alu. | <b>51086</b>    | <b>49,00</b> |



| XL6 | 3000K | 6W                    | 40°   |
|-----|-------|-----------------------|-------|
|     | h (m) | E <sub>max</sub> (lx) | d (m) |
|     | 1     | 947                   | 0,73  |
|     | 2     | 237                   | 1,5   |
|     | 2,5   | 152                   | 1,8   |

| XL6 | 4000K | 6W                    | 40°   |
|-----|-------|-----------------------|-------|
|     | h (m) | E <sub>max</sub> (lx) | d (m) |
|     | 1     | 1020                  | 0,73  |
|     | 2     | 255                   | 1,5   |
|     | 2,5   | 163                   | 1,8   |

HIDRO



Blanc



Chrome



Nickel

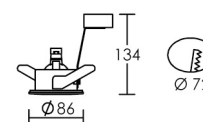

Corps aluminium/ Verre de protection et joint d'étanchéité. Fixe.

Sans lampe - Douille GU10



| P (w) | Douille | Couleur | Code | € HT  |
|-------|---------|---------|------|-------|
| 50    | GU10    | blanc   | 4076 | 12,80 |
| 50    | GU10    | nickel  | 4077 | 12,80 |

Avec lampe LED XL6



Précâblage 0,35 m avec connecteur. Alimentation 500mA, classe 2, IP20. Spot classe 3.

635 lm

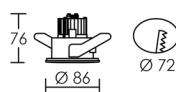

| XL6   | 3000K                 | 6W    | 40° |
|-------|-----------------------|-------|-----|
| h (m) | E <sub>max</sub> (lx) | d (m) |     |
| 1     | 947                   | 0,73  |     |
| 2     | 237                   | 1,5   |     |
| 2,5   | 152                   | 1,8   |     |

| XL6   | 4000K                 | 6W    | 40° |
|-------|-----------------------|-------|-----|
| h (m) | E <sub>max</sub> (lx) | d (m) |     |
| 1     | 1020                  | 0,73  |     |
| 2     | 255                   | 1,5   |     |
| 2,5   | 163                   | 1,8   |     |

Données de la lampe seule.

| 6W     | 40°    | 35 000 h |       |       |
|--------|--------|----------|-------|-------|
| Lumens | Teinte | Couleur  | Code  | € HT  |
| 590    | 3000 K | blanc    | 51078 | 53,50 |
| 635    | 4000 K | blanc    | 51072 | 53,50 |
| 590    | 3000 K | nickel   | 51174 | 66,20 |
| 635    | 4000 K | nickel   | 51175 | 66,20 |
| 590    | 3000 K | chrome   | 51079 | 65,80 |
| 635    | 4000 K | chrome   | 51073 | 65,80 |

### Sans lampe - Douille GU5,3



| P (w) | Douille | Couleur | Code         | € HT         |
|-------|---------|---------|--------------|--------------|
| 50    | GU5,3   | blanc   | <b>4075*</b> | <b>14,20</b> |
| 50    | GU5,3   | chrome  | <b>4066*</b> | <b>15,70</b> |
| 50    | GU5,3   | nickel  | <b>4069*</b> | <b>14,60</b> |

### Avec lampe LED GU5,3 6W



385 lm

Alimentation, classe 2, IP20. Spot classe 3.

| 6W     | 36°    |         |              | 15 000 h     |
|--------|--------|---------|--------------|--------------|
| Lumens | Teinte | Couleur | Code         | € HT         |
| 370    | 3000 K | blanc   | <b>51044</b> | <b>34,40</b> |
| 385    | 4000 K | blanc   | <b>51045</b> | <b>34,40</b> |
| 370    | 3000 K | nickel  | <b>51026</b> | <b>35,40</b> |
| 385    | 4000 K | nickel  | <b>51027</b> | <b>35,40</b> |
| 370    | 3000 K | chrome  | <b>51028</b> | <b>35,40</b> |
| 385    | 4000 K | chrome  | <b>51029</b> | <b>35,40</b> |

| HIDRO | 3000K | 6W                    | 36°   |  |
|-------|-------|-----------------------|-------|--|
|       | h (m) | E <sub>max</sub> (lx) | d (m) |  |
|       | 1     | <b>860</b>            | 0,65  |  |
|       | 2     | <b>215</b>            | 1,3   |  |
|       | 2,5   | <b>138</b>            | 1,6   |  |

| HIDRO | 4000K | 6W                    | 36°   |  |
|-------|-------|-----------------------|-------|--|
|       | h (m) | E <sub>max</sub> (lx) | d (m) |  |
|       | 1     | <b>872</b>            | 0,65  |  |
|       | 2     | <b>218</b>            | 1,3   |  |
|       | 2,5   | <b>140</b>            | 1,6   |  |

### Avec lampe LED GU5,3 8W



560 lm

Alimentation, classe 2, IP20. Spot classe 3.

| 8W     | 36°    |         |              | 15 000 h     |
|--------|--------|---------|--------------|--------------|
| Lumens | Teinte | Couleur | Code         | € HT         |
| 540    | 2700 K | blanc   | <b>50210</b> | <b>36,70</b> |
| 560    | 4000 K | blanc   | <b>50207</b> | <b>36,70</b> |
| 540    | 2700 K | nickel  | <b>51058</b> | <b>37,70</b> |
| 560    | 4000 K | nickel  | <b>50208</b> | <b>37,70</b> |
| 540    | 2700 K | chrome  | <b>51059</b> | <b>37,70</b> |
| 560    | 4000 K | chrome  | <b>50209</b> | <b>37,70</b> |

| 50210 | 2700K | 8W                    | 36°   |  |
|-------|-------|-----------------------|-------|--|
|       | h (m) | E <sub>max</sub> (lx) | d (m) |  |
|       | 1     | <b>958</b>            | 0,65  |  |
|       | 2     | <b>239</b>            | 1,3   |  |
|       | 2,5   | <b>153</b>            | 1,6   |  |

| 50207 | 4000K | 8W                    | 36°   |  |
|-------|-------|-----------------------|-------|--|
|       | h (m) | E <sub>max</sub> (lx) | d (m) |  |
|       | 1     | <b>986</b>            | 0,65  |  |
|       | 2     | <b>246</b>            | 1,3   |  |
|       | 2,5   | <b>158</b>            | 1,6   |  |

### Avec lampe halogène GU5,3 50W



Alimentation électronique classe 2 IP20. Spot IP20/65, classe 3.

| 50W     | 36°     |         |             | 3 000 h      |
|---------|---------|---------|-------------|--------------|
| Candéla | Douille | Couleur | Code        | € HT         |
| 1450    | GU5,3   | blanc   | <b>4095</b> | <b>28,20</b> |

La lampe incluse dans ce kit répond aux exigences d'éco-conception de l'étape 3 du règlement européen 1194/2012.

ZETA

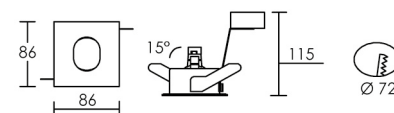
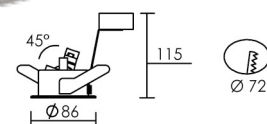
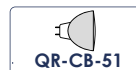

Corps acier et joint d'étanchéité. Orientable.

Sans lampe - Douille GU5,3 - IP20

Pas de verre de protection.



| P (w) | Douille | Couleur | Code ROND | € HT  | Code CARRÉ | € HT |
|-------|---------|---------|-----------|-------|------------|------|
| 50    | GU5,3   | blanc   | 4087      | 11,20 | -          | -    |

Sans lampe - Douille GU5,3 - IP65

Verre de protection.



| P (w) | Douille | Couleur       | Code ROND | € HT  | Code CARRÉ | € HT  |
|-------|---------|---------------|-----------|-------|------------|-------|
| 50    | GU5,3   | blanc         | 4805      | 14,30 | 4843       | 15,30 |
| 50    | GU5,3   | nickel brossé | 4807      | 15,30 | 4873       | 16,30 |

### Avec lampe LED GU5,3 6W - IP65



Verre de protection. Alimentation classe 2, IP20. Spot classe 3.

480 lm

|       |                       |       |     |       |                       |       |     |
|-------|-----------------------|-------|-----|-------|-----------------------|-------|-----|
| 2975  | 3000K                 | 6w    | 36° | 2976  | 4000K                 | 6w    | 36° |
| h (m) | E <sub>max</sub> (lx) | d (m) |     | h (m) | E <sub>max</sub> (lx) | d (m) |     |
| 1     | 1075                  | 0,65  |     | 1     | 1090                  | 0,65  |     |
| 2     | 269                   | 1,3   |     | 2     | 273                   | 1,3   |     |
| 2,5   | 172                   | 1,6   |     | 2,5   | 174                   | 1,6   |     |

Données de la lampe.

| 6W     |        | ◁ 36°         |           | 15 000 h |            |       |  |
|--------|--------|---------------|-----------|----------|------------|-------|--|
| Lumens | Teinte | Couleur       | Code ROND | € HT     | Code CARRÉ | € HT  |  |
| 460    | 3000 K | blanc         | 51164     | 32,60    | 51160      | 32,60 |  |
| 480    | 4000 K | blanc         | 51165     | 32,60    | 51161      | 32,60 |  |
| 460    | 3000 K | nickel brossé | 51166     | 31,60    | 51162      | 31,60 |  |
| 480    | 4000 K | nickel brossé | 51167     | 31,60    | 51163      | 31,60 |  |

### Avec lampe LED GU5,3 8W - IP65



Verre de protection. Alimentation classe 2, IP20. Spot classe 3.

700 lm

|       |                       |       |     |       |                       |       |     |
|-------|-----------------------|-------|-----|-------|-----------------------|-------|-----|
| 20050 | 2700 K                | 8W    | 36° | 20051 | 4000 K                | 8W    | 36° |
| h (m) | E <sub>max</sub> (lx) | d (m) |     | h (m) | E <sub>max</sub> (lx) | d (m) |     |
| 1     | 1197                  | 0,65  |     | 1     | 1232                  | 0,65  |     |
| 2     | 299                   | 1,3   |     | 2     | 308                   | 1,3   |     |
| 2,5   | 192                   | 1,6   |     | 2,5   | 197                   | 1,6   |     |

Données de la lampe.

| 8W     |        | ◁ 36°         |           | 15 000 h |            |       |  |
|--------|--------|---------------|-----------|----------|------------|-------|--|
| Lumens | Teinte | Couleur       | Code ROND | € HT     | Code CARRÉ | € HT  |  |
| 680    | 2700 K | blanc         | 51156     | 33,70    | 51158      | 33,70 |  |
| 700    | 4000 K | blanc         | 50213     | 33,70    | 50215      | 33,70 |  |
| 680    | 2700 K | nickel brossé | 51157     | 34,70    | 51159      | 34,70 |  |
| 700    | 4000 K | nickel brossé | 50214     | 34,70    | 50216      | 34,70 |  |

## SPEED 50 IP65

Fixe



Corps aluminium/Verre de protection. Fixe.

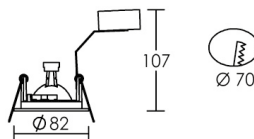

|   | P (w) | Douille | Couleur      | Code sans lampe | € HT  |
|---|-------|---------|--------------|-----------------|-------|
| N | 50    | GU10    | blanc        | 4067            | 11,00 |
| N | 50    | GU10    | nickel satin | 4068            | 14,00 |

## ELODY 2 - 6W



600 lm

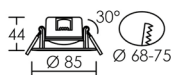

Corps et diffuseur polycarbonate blanc/Dissipateur aluminium. Orientable. **Alimentation intégrée.**

| 40°   |        |          |              | 30 000 h     |
|-------|--------|----------|--------------|--------------|
| P (w) | Lumens | Teinte   | Code         | € HT         |
| 6     | 550    | ● 3000 K | <b>50745</b> | <b>17,90</b> |
| 6     | 600    | ○ 4000 K | <b>50746</b> | <b>17,90</b> |

| 50745 | 3000K                 | 6W    | 40° |
|-------|-----------------------|-------|-----|
| h (m) | E <sub>max</sub> (lx) | d (m) |     |
| 1     | <b>602</b>            | 0,73  |     |
| 2     | <b>151</b>            | 1,5   |     |
| 3     | <b>67</b>             | 2,2   |     |

| 50746 | 4000K                 | 6W    | 40° |
|-------|-----------------------|-------|-----|
| h (m) | E <sub>max</sub> (lx) | d (m) |     |
| 1     | <b>652</b>            | 0,73  |     |
| 2     | <b>163</b>            | 1,5   |     |
| 3     | <b>72</b>             | 2,2   |     |

## ELODY 10W



1000 lm

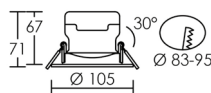

Corps et diffuseur polycarbonate blanc/Dissipateur aluminium. Orientable. **Alimentation intégrée.**

| 36°   |        |          |              | 30 000 h     |
|-------|--------|----------|--------------|--------------|
| P (w) | Lumens | Teinte   | Code         | € HT         |
| 10    | 950    | ● 3000 K | <b>50403</b> | <b>25,50</b> |
| 10    | 1000   | ○ 4000 K | <b>50404</b> | <b>25,50</b> |

| 50403 | 3000 K                | 10 W  | 36° |
|-------|-----------------------|-------|-----|
| h (m) | E <sub>max</sub> (lx) | d (m) |     |
| 1     | <b>1728</b>           | 0,65  |     |
| 2     | <b>432</b>            | 1,3   |     |
| 3     | <b>192</b>            | 1,9   |     |

| 50404 | 4000 K                | 10 W  | 36° |
|-------|-----------------------|-------|-----|
| h (m) | E <sub>max</sub> (lx) | d (m) |     |
| 1     | <b>1873</b>           | 0,65  |     |
| 2     | <b>468</b>            | 1,3   |     |
| 3     | <b>208</b>            | 1,9   |     |

MI 6



470 lm

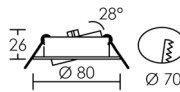

Corps aluminium. Optique en retrait pour un bon confort visuel. Basculant. **Alimentation intégrée.** Profondeur d'encastrement minimale (seulement 26 mm).

5,5W ◀ 40° 25 000 h

| Lumens | Teinte | Couleur | Code         | € HT         |
|--------|--------|---------|--------------|--------------|
| 450    | 3000 K | blanc   | <b>50619</b> | <b>13,30</b> |
| 470    | 4000 K | blanc   | <b>50620</b> | <b>13,30</b> |
| 450    | 3000 K | nickel  | <b>50621</b> | <b>13,30</b> |
| 470    | 4000 K | nickel  | <b>50622</b> | <b>13,30</b> |

| 50619 | 3000 K         | 5,5W  | 40° |
|-------|----------------|-------|-----|
| h (m) | $E_{max}$ (lx) | d (m) |     |
| 1     | <b>727</b>     | 0,73  |     |
| 2     | <b>182</b>     | 1,5   |     |
| 3     | <b>81</b>      | 2,2   |     |

| 50620 | 4000 K         | 5,5W  | 40° |
|-------|----------------|-------|-----|
| h (m) | $E_{max}$ (lx) | d (m) |     |
| 1     | <b>760</b>     | 0,73  |     |
| 2     | <b>190</b>     | 1,5   |     |
| 3     | <b>84</b>      | 2,2   |     |

EYDI



630 lm

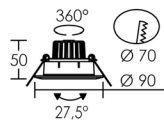

Corps et diffuseur polycarbonate blanc. Orientable. **Alimentation intégrée.**

◀ 55° 25 000 h

| P (w) | Lumens | Teinte | Code         | € HT         |
|-------|--------|--------|--------------|--------------|
| 8     | 600    | 2700 K | <b>50421</b> | <b>26,00</b> |
| 8     | 630    | 4000 K | <b>50422</b> | <b>26,00</b> |

Dimmable par coupure de phase.

| 50421 | 2700K          | 8W    | 60° |
|-------|----------------|-------|-----|
| h (m) | $E_{max}$ (lx) | d (m) |     |
| 1     | <b>395</b>     | 1,15  |     |
| 2     | <b>99</b>      | 2,31  |     |
| 2,5   | <b>63</b>      | 2,89  |     |

| 50422 | 4000K          | 8W    | 60° |
|-------|----------------|-------|-----|
| h (m) | $E_{max}$ (lx) | d (m) |     |
| 1     | <b>447</b>     | 1,15  |     |
| 2     | <b>112</b>     | 2,31  |     |
| 2,5   | <b>72</b>      | 2,89  |     |

**KIT ELITE**



1100 lm

Corps aluminium blanc. Fixe. Kit prêt-à-posers. Alimentation 350 mA, classe 2. Spot classe 3.

**Version F5 - Fixe**

IP 20



13W 50 000 h

| Faisceau | Lumens | Teinte   | Code  | € HT  |
|----------|--------|----------|-------|-------|
| 36°      | 1100   | ● 3000 K | 50130 | 64,30 |
| 36°      | 1100   | ○ 4000 K | 50131 | 64,30 |
| 60°      | 1100   | ● 3000 K | 50132 | 64,30 |
| 60°      | 1100   | ○ 4000 K | 50133 | 64,30 |

Dimmable par coupure de phase.

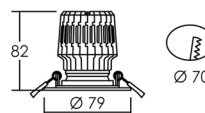

**Version S5 - Fixe**

IP 20



13W 50 000 h

| Faisceau | Lumens | Teinte   | Code  | € HT  |
|----------|--------|----------|-------|-------|
| 36°      | 1100   | ● 3000 K | 50134 | 64,30 |
| 36°      | 1100   | ○ 4000 K | 50135 | 64,30 |
| 60°      | 1100   | ● 3000 K | 50136 | 64,30 |
| 60°      | 1100   | ○ 4000 K | 50137 | 64,30 |

Dimmable par coupure de phase.

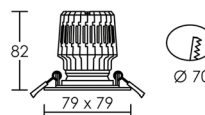

**Version F6 - Fixe**

IP 20



13W 50 000 h

| Faisceau | Lumens | Teinte   | Code  | € HT  |
|----------|--------|----------|-------|-------|
| 36°      | 1100   | ● 3000 K | 50150 | 64,90 |
| 36°      | 1100   | ○ 4000 K | 50151 | 64,90 |
| 60°      | 1100   | ● 3000 K | 50152 | 64,90 |
| 60°      | 1100   | ○ 4000 K | 50153 | 64,90 |

Dimmable par coupure de phase.

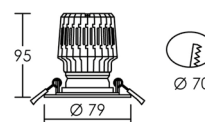



Version A5 - Orientable

IP 20



13W 50 000 h

| Faisceau | Lumens | Teinte | Code  | € HT  |
|----------|--------|--------|-------|-------|
| 36°      | 1100   | 3000 K | 50138 | 69,60 |
| 36°      | 1100   | 4000 K | 50139 | 69,60 |
| 60°      | 1100   | 3000 K | 50140 | 69,60 |
| 60°      | 1100   | 4000 K | 50141 | 69,60 |

Dimmable par coupure de phase.

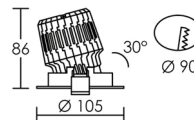

Version F4 - Fixe

IP 20  
IP 44  
VOL.2



Verre de protection.

13W 50 000 h

| Faisceau | Lumens | Teinte | Code  | € HT  |
|----------|--------|--------|-------|-------|
| 36°      | 1100   | 3000 K | 50154 | 70,30 |
| 36°      | 1100   | 4000 K | 50155 | 70,30 |
| 60°      | 1100   | 3000 K | 50156 | 70,30 |
| 60°      | 1100   | 4000 K | 50157 | 70,30 |

Dimmable par coupure de phase.

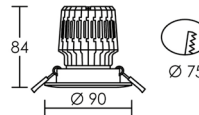

Gamme ELITE 13W



UGR < 19

DIMMABLE

✓ Radiateur alu.  
24 ailettes



✓ Durée de vie :  
50 000 h

✓ Basse luminance :  
UGR < 19



✓ Adapté lieux de  
travail

| ELITE 13 13 w 36° |        |       |  |
|-------------------|--------|-------|--|
| h (m)             | E (lx) | d (m) |  |
| 1                 | 2424   | 0,65  |  |
| 2                 | 606    | 1,3   |  |
| 3                 | 269    | 2,0   |  |

| ELITE 13 13 w 60° |        |       |  |
|-------------------|--------|-------|--|
| h (m)             | E (lx) | d (m) |  |
| 1                 | 1393   | 1,16  |  |
| 2                 | 348    | 2,3   |  |
| 3                 | 155    | 3,5   |  |

## RANDY S



680 lm

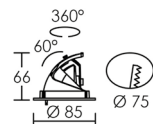

Corps et réflecteur aluminium. Basculant. Blanc.  
Alimentation 350mA, classe 2, IP20. Spot classe 3.

| 36°   |        | 40 000 h |              |              |
|-------|--------|----------|--------------|--------------|
| P (w) | Lumens | Teinte   | Code         | € HT         |
| 7,5   | 635    | ● 3000 K | <b>50453</b> | <b>63,20</b> |
| 7,5   | 680    | ○ 4000 K | <b>50443</b> | <b>63,20</b> |

| 50453 | 3000K                 | 10,5W | 30° |
|-------|-----------------------|-------|-----|
| h (m) | E <sub>max</sub> (lx) | d (m) |     |
| 1     | <b>2416</b>           | 0,54  |     |
| 2     | <b>604</b>            | 1,1   |     |
| 3     | <b>268</b>            | 1,6   |     |

| 50443 | 4000K                 | 10,5W | 30° |
|-------|-----------------------|-------|-----|
| h (m) | E <sub>max</sub> (lx) | d (m) |     |
| 1     | <b>2416</b>           | 0,54  |     |
| 2     | <b>604</b>            | 1,1   |     |
| 3     | <b>268</b>            | 1,6   |     |

## DL-ISO IP20



840 lm

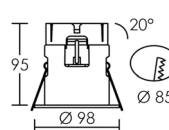

Corps en acier noir/Capot en polycarbonate/  
Réflecteur aluminium à facettes. Basculant.  
Alimentation 200 mA fournie, séparée (ne pas recouvrir).

| 8W     |          | 65°     |              |              | 40 000 h |  |
|--------|----------|---------|--------------|--------------|----------|--|
| Lumens | Teinte   | Couleur | Code         | € HT         |          |  |
| 800    | ● 3000 K | blanc   | <b>50631</b> | <b>50,00</b> |          |  |
| 840    | ○ 4000 K | blanc   | <b>50632</b> | <b>50,00</b> |          |  |
| 800    | ● 3000 K | nickel  | <b>50633</b> | <b>53,00</b> |          |  |
| 840    | ○ 4000 K | nickel  | <b>50634</b> | <b>53,00</b> |          |  |

Dimmable par coupure de fin de phase.

| 50631 | 3000K                 | 8W    | 65° |
|-------|-----------------------|-------|-----|
| h (m) | E <sub>max</sub> (lx) | d (m) |     |
| 1     | <b>710</b>            | 1,27  |     |
| 2     | <b>178</b>            | 2,5   |     |
| 2,5   | <b>114</b>            | 3,2   |     |

| 50632 | 4000K                 | 8W    | 65° |
|-------|-----------------------|-------|-----|
| h (m) | E <sub>max</sub> (lx) | d (m) |     |
| 1     | <b>746</b>            | 1,27  |     |
| 2     | <b>187</b>            | 2,5   |     |
| 2,5   | <b>119</b>            | 3,2   |     |

## RIVA 10W



950 lm

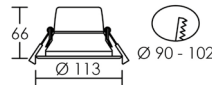

Corps et réflecteur aluminium. Fixe. Précâblage 0,25 m. Alimentation 350mA séparée pré-câblée, classe 2, IP20.

| ◀ 50° |        | 35 000 h |              |              |
|-------|--------|----------|--------------|--------------|
| P (w) | Lumens | Teinte   | Code         | € HT         |
| 10    | 900    | ● 3000 K | <b>50600</b> | <b>39,80</b> |
| 10    | 950    | ○ 4000 K | <b>50601</b> | <b>39,80</b> |

Dimmable par coupure de phase.

| 50600 | 3000K                 | 10 W  | 50° |
|-------|-----------------------|-------|-----|
| h (m) | E <sub>max</sub> (lx) | d (m) |     |
| 1     | <b>1284</b>           | 0,93  |     |
| 2     | <b>321</b>            | 1,9   |     |
| 3     | <b>143</b>            | 2,8   |     |

| 50601 | 4000K                 | 10 W  | 50° |
|-------|-----------------------|-------|-----|
| h (m) | E <sub>max</sub> (lx) | d (m) |     |
| 1     | <b>1377</b>           | 0,93  |     |
| 2     | <b>344</b>            | 1,9   |     |
| 3     | <b>153</b>            | 2,8   |     |

## K8



730 lm

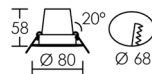

Corps aluminium. Optique en retrait pour un bon confort visuel. Orientable. Alimentation intégrée. Précâblé H03VVH2-F, long. 20 cm.

| ◀ 55°  |          | 25 000 h |              |              |
|--------|----------|----------|--------------|--------------|
| Lumens | Teinte   | Couleur  | Code         | € HT         |
| 680    | ● 3000 K | blanc    | <b>50534</b> | <b>15,30</b> |
| 730    | ○ 4000 K | blanc    | <b>50535</b> | <b>15,30</b> |
| 680    | ● 3000 K | nickel   | <b>50536</b> | <b>19,40</b> |
| 730    | ○ 4000 K | nickel   | <b>50537</b> | <b>19,40</b> |

Dimmable par coupure de phase.

| 50534 | 3000 K                | 8W    | 45° |
|-------|-----------------------|-------|-----|
| h (m) | E <sub>max</sub> (lx) | d (m) |     |
| 1     | <b>1034</b>           | 0,83  |     |
| 2     | <b>259</b>            | 1,7   |     |
| 3     | <b>115</b>            | 2,5   |     |

| 50535 | 4000 K                | 8W    | 45° |
|-------|-----------------------|-------|-----|
| h (m) | E <sub>max</sub> (lx) | d (m) |     |
| 1     | <b>1083</b>           | 0,83  |     |
| 2     | <b>271</b>            | 1,7   |     |
| 3     | <b>120</b>            | 2,5   |     |

## FLAT 5W



450 lm



Corps aluminium/Diffuseur PMMA opale. Fixe.  
Alimentation séparée pré-câblée, classe 2, IP20.

5W ◀ 110° 35 000 h

| Lumens | Teinte   | Couleur | Code  | € HT  |
|--------|----------|---------|-------|-------|
| 400    | ● 3000 K | blanc   | 50459 | 17,50 |
| 450    | ○ 4000 K | blanc   | 50359 | 17,50 |

| 50459 | 3000K                 | 5 W   | 110° |
|-------|-----------------------|-------|------|
| h (m) | E <sub>max</sub> (lx) | d (m) |      |
| 1     | 139                   | 2,86  |      |
| 2     | 35                    | 5,7   |      |
| 2,5   | 22                    | 7,1   |      |

| 50359 | 4000K                 | 5 W   | 110° |
|-------|-----------------------|-------|------|
| h (m) | E <sub>max</sub> (lx) | d (m) |      |
| 1     | 156                   | 2,86  |      |
| 2     | 39                    | 5,7   |      |
| 2,5   | 25                    | 7,1   |      |

## MI 5



520 lm

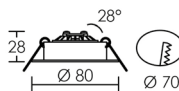

Corps aluminium/Diffuseur polycarbonate cristal.  
Basculant. Alimentation 128 mA, classe 2, IP20.

5,5W ◀ 36° 25 000 h

| Lumens | Teinte   | Couleur | Code  | € HT  |
|--------|----------|---------|-------|-------|
| 480    | ● 3000 K | blanc   | 50431 | 18,10 |
| 520    | ○ 4000 K | blanc   | 50432 | 18,10 |
| 480    | ● 3000 K | nickel  | 50478 | 18,10 |
| 520    | ○ 4000 K | nickel  | 50479 | 18,10 |

| 50431 | 3000 K                | 5,5 W | 36° |
|-------|-----------------------|-------|-----|
| h (m) | E <sub>max</sub> (lx) | d (m) |     |
| 1     | 910                   | 0,65  |     |
| 2     | 228                   | 1,3   |     |
| 2,5   | 146                   | 1,6   |     |

| 50432 | 4000 K                | 5,5 W | 36° |
|-------|-----------------------|-------|-----|
| h (m) | E <sub>max</sub> (lx) | d (m) |     |
| 1     | 986                   | 0,65  |     |
| 2     | 247                   | 1,3   |     |
| 2,5   | 158                   | 1,6   |     |



**SPEED 50**

Fixe

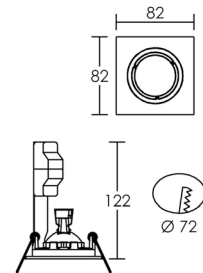
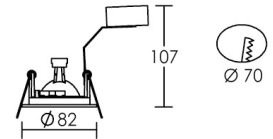

Corps aluminium. Fixe.

**Sans lampe - Douille GU5,3**



| P (w) | Douille | Couleur       | Code ROND   | € HT         |
|-------|---------|---------------|-------------|--------------|
| 50    | GU5,3   | blanc         | <b>4856</b> | <b>8,00</b>  |
| 50    | GU5,3   | nickel satiné | <b>4802</b> | <b>11,90</b> |

**Sans lampe - Douille GU10**



| P (w) | Douille | Couleur       | Code ROND   | € HT         | Code CARRÉ   | € HT         |
|-------|---------|---------------|-------------|--------------|--------------|--------------|
| 50    | GU10    | blanc         | <b>4893</b> | <b>9,70</b>  | <b>4970</b>  | <b>15,30</b> |
| 50    | GU10    | nickel satiné | <b>4894</b> | <b>13,60</b> | <b>4971*</b> | <b>15,30</b> |

EXISTE EN VERSION IP65 (voir p. 85)

\*ATTENTION : peinture grise.

**Avec lampe LED GU10 6W**



**500 lm**

| 6W     | 36°    | GU10    | 15 000 h     |              |  |
|--------|--------|---------|--------------|--------------|--|
| Lumens | Teinte | Couleur | Code ROND    | € HT         |  |
| 470    | 3000 K | blanc   | <b>51168</b> | <b>11,20</b> |  |
| 500    | 4000 K | blanc   | <b>51169</b> | <b>11,20</b> |  |

| LED 6E | 3000K | 6W | 36° |       |                       |
|--------|-------|----|-----|-------|-----------------------|
|        |       |    |     | h (m) | E <sub>max</sub> (lx) |
|        |       |    |     | 1     | 972                   |
|        |       |    |     | 2     | 243                   |
|        |       |    |     | 2,5   | 156                   |
|        |       |    |     | d (m) |                       |
|        |       |    |     |       | 0,65                  |
|        |       |    |     |       | 1,3                   |
|        |       |    |     |       | 1,6                   |

**SPEED 70**

Orientable

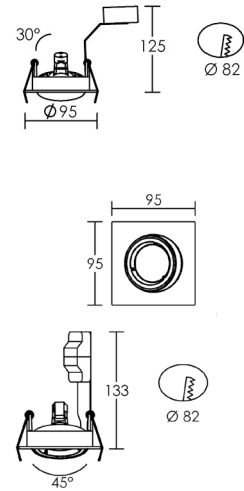

Corps aluminium. Orientable.

**Sans lampe - Douille GU5,3**



| P (w) | Douille | Couleur       | Code ROND   | € HT         | Code CARRÉ  | € HT         |
|-------|---------|---------------|-------------|--------------|-------------|--------------|
| 50    | GU5,3   | blanc         | <b>4899</b> | <b>11,90</b> | <b>4852</b> | <b>20,90</b> |
| 50    | GU5,3   | nickel satiné | <b>4836</b> | <b>15,50</b> | -           | -            |

**Sans lampe - Douille GU10**



| P (w) | Douille | Couleur       | Code ROND   | € HT         | Code CARRÉ   | € HT         |
|-------|---------|---------------|-------------|--------------|--------------|--------------|
| 50    | GU10    | blanc         | <b>4895</b> | <b>12,80</b> | <b>4972</b>  | <b>21,70</b> |
| 50    | GU10    | nickel satiné | <b>4896</b> | <b>16,30</b> | <b>4973*</b> | <b>21,70</b> |

\*ATTENTION : peinture grise.

**Avec lampe LED GU10 6W**



| 6W     | 36°    | GU10    | 15 000 h     |              |  |
|--------|--------|---------|--------------|--------------|--|
| Lumens | Teinte | Couleur | Code ROND    | € HT         |  |
| 470    | 3000 K | blanc   | <b>51170</b> | <b>16,10</b> |  |
| 500    | 4000 K | blanc   | <b>51171</b> | <b>16,10</b> |  |

**500 lm**

| LED 6E | 3000K                 | 6W    | 36° | LED 6E | 4000K                 | 6W    | 36° |
|--------|-----------------------|-------|-----|--------|-----------------------|-------|-----|
| h (m)  | E <sub>max</sub> (lx) | d (m) |     | h (m)  | E <sub>max</sub> (lx) | d (m) |     |
| 1      | <b>972</b>            | 0,65  |     | 1      | <b>1035</b>           | 0,65  |     |
| 2      | <b>243</b>            | 1,3   |     | 2      | <b>259</b>            | 1,3   |     |
| 2,5    | <b>156</b>            | 1,6   |     | 2,5    | <b>166</b>            | 1,6   |     |

**SPEED 90**

Orientable

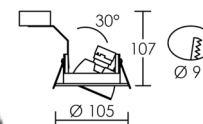

Corps aluminium. Orientable.

**Sans lampe - Douille GU10**

| P (w) | Douille | Couleur      | Code        | € HT         |
|-------|---------|--------------|-------------|--------------|
| 50    | GU10    | blanc        | <b>4897</b> | <b>15,50</b> |
| 50    | GU10    | nickel satin | <b>4898</b> | <b>18,40</b> |

**Avec lampe LED GU10 6W**



500 lm

| LED 6E | 3000K | 6W                    | 36°   |
|--------|-------|-----------------------|-------|
|        | h (m) | E <sub>max</sub> (lx) | d (m) |
|        | 1     | <b>972</b>            | 0,65  |
|        | 2     | <b>243</b>            | 1,3   |
|        | 2,5   | <b>156</b>            | 1,6   |

| LED 6E | 4000K | 6W                    | 36°   |
|--------|-------|-----------------------|-------|
|        | h (m) | E <sub>max</sub> (lx) | d (m) |
|        | 1     | <b>1035</b>           | 0,65  |
|        | 2     | <b>259</b>            | 1,3   |
|        | 2,5   | <b>166</b>            | 1,6   |

6W ◁ 36° GU10 15 000 h

| Lumens | Teinte | Couleur | Code         | € HT         |
|--------|--------|---------|--------------|--------------|
| 470    | 3000 K | blanc   | <b>51172</b> | <b>18,80</b> |
| 500    | 4000 K | blanc   | <b>51173</b> | <b>18,80</b> |

**SPEED 110**

Basculant

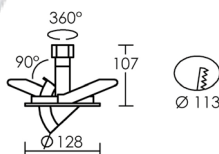
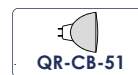

Corps aluminium. Basculant.

| P (w) | Douille | Couleur | Code sans lampe | € HT         |
|-------|---------|---------|-----------------|--------------|
| 50    | GU5,3   | blanc   | <b>4845</b>     | <b>30,40</b> |



## SPOTISOL

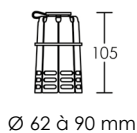

Accessoire de pose pour encastré de plafond.

SPOTISOL permet de **séparer les spots des isolants rouleau** tout en maintenant le boîtier de connexion du spot.

- Diamètres compris entre 62 et 90 mm ;
- Hauteur : 105 mm ;
- Utilisable de -20°C à +110°C en continu ;
- Puissance maximum : 50W avec isolation en rouleau ;
- Résistance au feu : auto-extinguible UL94 V2.

Code € HT

3670 6,00



## Séparateur d'isolant rouleau



- ✓ Compatibilité tous types d'isolant rouleau de classe MO incombustible
- ✓ Compatible avec les spots halogènes et LED
- ✓ Montage sans outil
- ✓ Plus besoin d'accéder aux combles

- ① Fixation possible du boîtier de connexion sur le haut du pot
- ② Sa conception permet son maintien dans les faux plafonds : impossible de le perdre

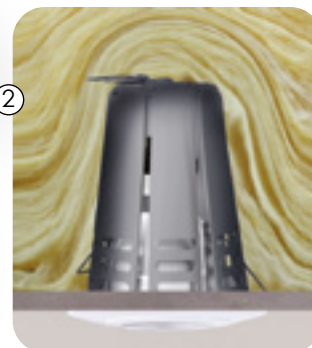

TIPO

Orientable et basculant

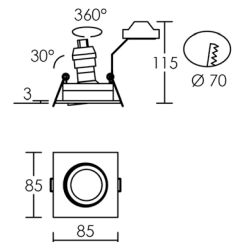
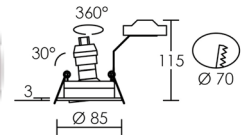

Corps aluminium. Orientable et basculant

Sans lampe - Douille GU5,3



| P (w) | Douille | Couleur     | Code ROND | € HT  | Code CARRÉ | € HT  |
|-------|---------|-------------|-----------|-------|------------|-------|
| 50    | G5,3    | blanc       | 4131      | 22,30 | 4133       | 23,40 |
| 50    | G5,3    | alu. brossé | 4132      | 22,30 | 4134       | 23,40 |

Avec lampe LED XL6



Alimentation 500 mA, classe 2, IP20. Spot classe 3. Précâblage 0,35 m avec connecteur.

590 lm

| 51071 | 3000K                 | 6W    | 40° |
|-------|-----------------------|-------|-----|
| h (m) | E <sub>max</sub> (lx) | d (m) |     |
| 1     | 947                   | 0,73  |     |
| 2     | 237                   | 1,5   |     |
| 2,5   | 152                   | 1,8   |     |

| 6W     | 40°    |             |           |       | 35 000 h   |       |
|--------|--------|-------------|-----------|-------|------------|-------|
| Lumens | Teinte | Couleur     | Code ROND | € HT  | Code CARRÉ | € HT  |
| 590    | 3000 K | blanc       | 51096     | 66,20 | 51098      | 67,20 |
| 590    | 3000 K | alu. brossé | 51097     | 66,20 | 51099      | 67,20 |

## Sans lampe - Douille GU10



| P (w) | Douille | Couleur     | Code ROND | € HT  | Code, CARRÉ | € HT  |
|-------|---------|-------------|-----------|-------|-------------|-------|
| 50    | GU10    | blanc       | 4144      | 19,40 | 4146        | 21,40 |
| 50    | GU10    | alu. brossé | 4145      | 19,40 | 4147        | 21,40 |

## Avec lampe LED GU10 STEP DIM 4,5W



390 lm

| 20030 | 2700K                 | 4,5W  | 40° | 20031 | 4000K                 | 4,5W  | 40° |
|-------|-----------------------|-------|-----|-------|-----------------------|-------|-----|
| h (m) | E <sub>max</sub> (lx) | d (m) |     | h (m) | E <sub>max</sub> (lx) | d (m) |     |
| 1     | 700                   | 0,73  |     | 1     | 700                   | 0,73  |     |
| 2     | 175                   | 1,5   |     | 2     | 175                   | 1,5   |     |
| 2,5   | 112                   | 1,8   |     | 2,5   | 112                   | 1,8   |     |

Voir détails de la variation STEP DIM p. 19.

4,5W ◀ 40° GU10 25 000 h

| Lumens | Teinte | Couleur     | Code ROND | € HT  | Code, CARRÉ | € HT  |
|--------|--------|-------------|-----------|-------|-------------|-------|
| 390    | 2700 K | blanc       | 51144     | 21,40 | 51148       | 23,50 |
| 390    | 4000 K | blanc       | 51145     | 21,40 | 51149       | 23,50 |
| 390    | 2700 K | alu. brossé | 51146     | 21,40 | 51150       | 23,50 |
| 390    | 4000 K | alu. brossé | 51147     | 21,40 | 51151       | 23,50 |

Dimmable par interrupteur : ne pas utiliser sur variateur.

## Avec lampe LED GU10 6W



500 lm

| LED 6E | 3000K                 | 6W    | 36° | LED 6E | 4000K                 | 6W    | 36° |
|--------|-----------------------|-------|-----|--------|-----------------------|-------|-----|
| h (m)  | E <sub>max</sub> (lx) | d (m) |     | h (m)  | E <sub>max</sub> (lx) | d (m) |     |
| 1      | 972                   | 0,65  |     | 1      | 1035                  | 0,65  |     |
| 2      | 243                   | 1,3   |     | 2      | 259                   | 1,3   |     |
| 2,5    | 156                   | 1,6   |     | 2,5    | 166                   | 1,6   |     |

6W ◀ 36° GU10 15 000 h

| Lumens | Teinte | Couleur     | Code ROND | € HT  | Code, CARRÉ | € HT  |
|--------|--------|-------------|-----------|-------|-------------|-------|
| 470    | 3000 K | blanc       | 51122     | 20,40 | 51126       | 22,40 |
| 500    | 4000 K | blanc       | 51123     | 20,40 | 51127       | 22,40 |
| 470    | 3000 K | alu. brossé | 51124     | 20,40 | 51128       | 22,40 |
| 500    | 4000 K | alu. brossé | 51125     | 20,40 | 51129       | 22,40 |

## Avec lampe LED GU10 7W



670 lm

| 2997  | 3000K                 | 7W    | 36° | 2998  | 4000K                 | 7W    | 36° |
|-------|-----------------------|-------|-----|-------|-----------------------|-------|-----|
| h (m) | E <sub>max</sub> (lx) | d (m) |     | h (m) | E <sub>max</sub> (lx) | d (m) |     |
| 1     | 1295                  | 0,65  |     | 1     | 1335                  | 0,65  |     |
| 2     | 324                   | 1,3   |     | 2     | 334                   | 1,3   |     |
| 2,5   | 207                   | 1,6   |     | 2,5   | 214                   | 1,6   |     |

7W ◀ 36° GU10 15 000 h

| Lumens | Teinte | Couleur     | Code ROND | € HT  | Code, CARRÉ | € HT  |
|--------|--------|-------------|-----------|-------|-------------|-------|
| 650    | 3000 K | blanc       | 51005     | 21,40 | 51046       | 23,50 |
| 670    | 4000 K | blanc       | 51006     | 21,40 | 51047       | 23,50 |
| 650    | 3000 K | alu. brossé | 51007     | 21,40 | 51048       | 23,50 |
| 670    | 4000 K | alu. brossé | 51008     | 21,40 | 51049       | 23,50 |



Blanc



Nickel

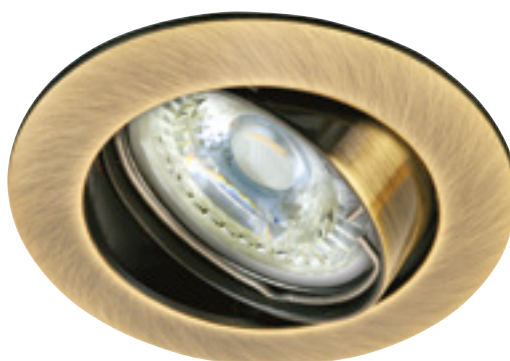
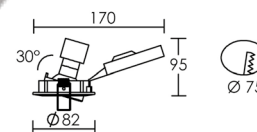

Vieux bronze



Doré

Corps aluminium. Basculant.

Sans lampe - Douille GU10



| P (w) | Douille | Couleur       | Code | € HT  |
|-------|---------|---------------|------|-------|
| 50    | GU10    | blanc         | 4890 | 12,00 |
| 50    | GU10    | doré          | 4892 | 14,70 |
| 50    | GU10    | nickel brossé | 4891 | 13,70 |
| 50    | GU10    | vieux bronze  | 4902 | 14,70 |

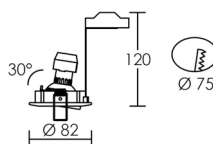

Avec lampe LED GU10 4W



260 lm

| LED 4 | 2700 K                | 4 W   | 45° |
|-------|-----------------------|-------|-----|
| h (m) | E <sub>max</sub> (lx) | d (m) |     |
| 1     | 367                   | 0,83  |     |
| 2     | 92                    | 1,7   |     |
| 2,5   | 59                    | 2,1   |     |

| 45°   | GU10   |          | 35 000 h       |      |
|-------|--------|----------|----------------|------|
| P (w) | Lumens | Teinte   | Code           | € HT |
| 4     | 260    | ● 2700 K | BLANC<br>51020 | 8,20 |

### Avec lampe LED GU10 STEP DIM 4,5W



390 lm

| 20030 | 2700K                 | 4,5W  | 40° | 20031 | 4000K                 | 4,5W  | 40° |
|-------|-----------------------|-------|-----|-------|-----------------------|-------|-----|
| h (m) | E <sub>max</sub> (lx) | d (m) |     | h (m) | E <sub>max</sub> (lx) | d (m) |     |
| 1     | 700                   | 0,73  |     | 1     | 700                   | 0,73  |     |
| 2     | 175                   | 1,5   |     | 2     | 175                   | 1,5   |     |
| 2,5   | 112                   | 1,8   |     | 2,5   | 112                   | 1,8   |     |

Voir détails de la variation STEP DIM p. 19.

#### 40° GU10 25 000 h

| P (w) | Lumens | Teinte | Code BLANC | € HT  | Code NICKEL | € HT  |
|-------|--------|--------|------------|-------|-------------|-------|
| 4,5   | 390    | 2700 K | 51152      | 16,30 | 51154       | 18,00 |
| 4,5   | 390    | 4000 K | 51153      | 16,30 | 51155       | 18,00 |

Dimmable par interrupteur : ne pas utiliser sur variateur.

### Avec lampe LED GU10 6W



480 lm



| LED 6 | 2700 K                | 6 W   | 50° | LED 6 | 4000 K                | 6 W   | 50° |
|-------|-----------------------|-------|-----|-------|-----------------------|-------|-----|
| h (m) | E <sub>max</sub> (lx) | d (m) |     | h (m) | E <sub>max</sub> (lx) | d (m) |     |
| 1     | 620                   | 0,93  |     | 1     | 632                   | 0,93  |     |
| 2     | 155                   | 1,9   |     | 2     | 158                   | 1,9   |     |
| 2,5   | 99                    | 2,3   |     | 2,5   | 101                   | 2,3   |     |

#### 50° GU10 20 000 h

| P (w) | Lumens | Teinte | Code BLANC | € HT  | Code NICKEL | € HT  |
|-------|--------|--------|------------|-------|-------------|-------|
| 6     | 460    | 2700 K | 5205       | 16,30 | 5238        | 16,30 |
| 6     | 480    | 4000 K | 5204       | 16,30 | 5239        | 16,30 |

### Avec lampe LED GU10 6-E



500 lm

| LED 6E | 3000K                 | 6W    | 36° | LED 6E | 4000K                 | 6W    | 36° |
|--------|-----------------------|-------|-----|--------|-----------------------|-------|-----|
| h (m)  | E <sub>max</sub> (lx) | d (m) |     | h (m)  | E <sub>max</sub> (lx) | d (m) |     |
| 1      | 972                   | 0,65  |     | 1      | 1035                  | 0,65  |     |
| 2      | 243                   | 1,3   |     | 2      | 259                   | 1,3   |     |
| 2,5    | 156                   | 1,6   |     | 2,5    | 166                   | 1,6   |     |

#### 36° GU10 15 000 h

| P (w) | Lumens | Teinte | Code BLANC | € HT  | Code NICKEL | € HT  |
|-------|--------|--------|------------|-------|-------------|-------|
| 6     | 470    | 3000 K | 51054      | 12,20 | 51176       | 13,90 |
| 6     | 500    | 4000 K | 51055      | 12,20 | 51177       | 13,90 |

### Avec lampe LED GU10 7W



670 lm

| 2997  | 3000K                 | 7 W   | 36° | 2998  | 4000K                 | 7 W   | 36° |
|-------|-----------------------|-------|-----|-------|-----------------------|-------|-----|
| h (m) | E <sub>max</sub> (lx) | d (m) |     | h (m) | E <sub>max</sub> (lx) | d (m) |     |
| 1     | 1295                  | 0,65  |     | 1     | 1335                  | 0,65  |     |
| 2     | 324                   | 1,3   |     | 2     | 334                   | 1,3   |     |
| 2,5   | 207                   | 1,6   |     | 2,5   | 214                   | 1,6   |     |

#### 36° GU10 20 000 h

| P (w) | Lumens | Teinte | Code BLANC | € HT  | Code NICKEL | € HT  |
|-------|--------|--------|------------|-------|-------------|-------|
| 7     | 650    | 3000 K | 51040      | 14,30 | 51042       | 15,90 |
| 7     | 670    | 4000 K | 51041      | 14,30 | 51043       | 15,90 |



Nickel



Noir



Blanc



Doré



Vieux bronze

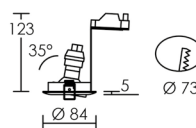

Corps aluminium. Basculant.

Sans lampe - Douille GU5,3

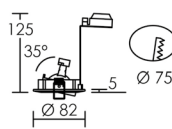

4875

| P (w) | Douille | Couleur | Code  | € HT  |
|-------|---------|---------|-------|-------|
| 50    | GU5,3   | blanc   | 4874  | 5,50  |
| 50    | GU5,3   | doré    | 4875* | 11,70 |
| 50    | GU5,3   | nickel  | 4887  | 7,60  |
| 50    | GU5,3   | bronze  | 4885  | 11,70 |
| 50    | GU5,3   | noir    | 4786  | 5,50  |

\* Dimensions différentes.

## Sans lampe - Douille GU10



| P (w) | Douille | Couleur      | Code SANS OUTIL | € HT  | Code BORNIER À VIS | € HT  |
|-------|---------|--------------|-----------------|-------|--------------------|-------|
| 50    | GU10    | blanc        | 4559*           | 9,30  | 4877               | 8,80  |
| 50    | GU10    | nickel       | 4560*           | 11,90 | 4550               | 9,80  |
| 50    | GU10    | vieux bronze | 4565*           | 13,00 | 4579               | 10,80 |
| 50    | GU10    | noir         | 4566*           | 9,30  | 4580               | 8,80  |

## Avec lampe LED GU10 GLASS LED 6W



500 lm

| GLASS | 3000K | 6W | 36° | h (m) | E <sub>max</sub> (lx) | d (m) |
|-------|-------|----|-----|-------|-----------------------|-------|
|       |       |    |     | 1     | 888                   | 0,65  |
|       |       |    |     | 2     | 222                   | 1,3   |
|       |       |    |     | 3     | 99                    | 1,9   |

| GLASS | 4000K | 6W | 36° | h (m) | E <sub>max</sub> (lx) | d (m) |
|-------|-------|----|-----|-------|-----------------------|-------|
|       |       |    |     | 1     | 888                   | 0,65  |
|       |       |    |     | 2     | 222                   | 1,3   |
|       |       |    |     | 3     | 99                    | 1,9   |

| 36° GU10 |        |        | 15 000 h   |       |             |       |
|----------|--------|--------|------------|-------|-------------|-------|
| P (w)    | Lumens | Teinte | Code BLANC | € HT  | Code NICKEL | € HT  |
| 6        | 500    | 3000 K | 51117      | 12,20 | 51119       | 14,30 |
| 6        | 500    | 4000 K | 51118      | 12,20 | 51120       | 14,30 |

## Avec lampe LED GU10 DIMMABLE 5,5W



410 lm

| GLASS | 3000K | 5,5 W | 36° | h (m) | E <sub>max</sub> (lx) | d (m) |
|-------|-------|-------|-----|-------|-----------------------|-------|
|       |       |       |     | 1     | 692                   | 0,65  |
|       |       |       |     | 2     | 173                   | 1,3   |
|       |       |       |     | 2,5   | 111                   | 1,6   |

| GLASS | 4000K | 5,5 W | 36° | h (m) | E <sub>max</sub> (lx) | d (m) |
|-------|-------|-------|-----|-------|-----------------------|-------|
|       |       |       |     | 1     | 692                   | 0,65  |
|       |       |       |     | 2     | 173                   | 1,3   |
|       |       |       |     | 2,5   | 111                   | 1,6   |

| 36° GU10 |        |        | 15 000 h   |       |             |       |
|----------|--------|--------|------------|-------|-------------|-------|
| P (w)    | Lumens | Teinte | Code BLANC | € HT  | Code NICKEL | € HT  |
| 5,5      | 410    | 3000 K | 51066      | 16,30 | 51136       | 17,30 |
| 5,5      | 410    | 4000 K | 51067      | 16,30 | 51137       | 17,30 |

Dimmable avec variateur universel.

## Avec lampe LED GU10 STEP DIM 4,5W



390 lm

| 20030 | 2700K | 4,5W | 40° | h (m) | E <sub>max</sub> (lx) | d (m) |
|-------|-------|------|-----|-------|-----------------------|-------|
|       |       |      |     | 1     | 700                   | 0,73  |
|       |       |      |     | 2     | 175                   | 1,5   |
|       |       |      |     | 2,5   | 112                   | 1,8   |

| 20031 | 4000K | 4,5W | 40° | h (m) | E <sub>max</sub> (lx) | d (m) |
|-------|-------|------|-----|-------|-----------------------|-------|
|       |       |      |     | 1     | 700                   | 0,73  |
|       |       |      |     | 2     | 175                   | 1,5   |
|       |       |      |     | 2,5   | 112                   | 1,8   |

| 40° GU10 |        |        | 25 000 h   |       |             |       |
|----------|--------|--------|------------|-------|-------------|-------|
| P (w)    | Lumens | Teinte | Code BLANC | € HT  | Code NICKEL | € HT  |
| 4,5      | 390    | 2700 K | 51138      | 13,30 | 51140       | 15,30 |
| 4,5      | 390    | 4000 K | 51139      | 13,30 | 51141       | 15,30 |

Dimmable par interrupteur : ne pas utiliser sur variateur.

Voir détails de la variation STEP DIM p. 19.



Blanc



Noir



Nickel



Doré



Vieux bronze

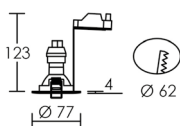

Corps aluminium. Fixe.

Sans lampe - Douille GU5,3



| P (w) | Douille | Couleur | Code        | € HT        |
|-------|---------|---------|-------------|-------------|
| 50    | GU5,3   | blanc   | <b>4854</b> | <b>4,30</b> |
| 50    | GU5,3   | doré    | <b>4855</b> | <b>9,70</b> |
| 50    | GU5,3   | nickel  | <b>4857</b> | <b>5,80</b> |
| 50    | GU5,3   | bronze  | <b>4884</b> | <b>9,70</b> |
| 50    | GU5,3   | noir    | <b>4785</b> | <b>4,30</b> |

Sans lampe - Douille GU10



| P (w) | Douille | Couleur      | Code SANS OUTIL | € HT        | Code BORNIER A VIS | € HT        |
|-------|---------|--------------|-----------------|-------------|--------------------|-------------|
| 50    | GU10    | blanc        | <b>4557*</b>    | <b>7,90</b> | <b>4872</b>        | <b>7,60</b> |
| 50    | GU10    | nickel       | <b>4558*</b>    | <b>8,90</b> | <b>4549</b>        | <b>8,60</b> |
| 50    | GU10    | vieux bronze | <b>4563*</b>    | <b>9,90</b> | <b>4571</b>        | <b>9,60</b> |
| 50    | GU10    | noir         | <b>4564*</b>    | <b>7,90</b> | <b>4572</b>        | <b>7,60</b> |



**DISK**

Fixe



Corps aluminium. Fixe.

| P (w) | Douille | Couleur       | Code sans lampe | € HT         |
|-------|---------|---------------|-----------------|--------------|
| 50    | GU10    | blanc         | <b>4880</b>     | <b>10,80</b> |
| 50    | GU10    | doré          | <b>4881</b>     | <b>13,60</b> |
| 50    | GU10    | nickel brossé | <b>4882</b>     | <b>12,30</b> |
| 50    | GU10    | vieux bronze  | <b>4883</b>     | <b>13,60</b> |

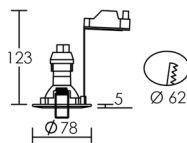

**SATURNE**

Fixe



Corps acier. Fixe.

| P (w) | Douille | Couleur       | Code sans lampe | € HT        |
|-------|---------|---------------|-----------------|-------------|
| 50    | GU5,3   | nickel brossé | <b>4605</b>     | <b>8,30</b> |
| 50    | GU5,3   | noir          | <b>4600</b>     | <b>6,40</b> |

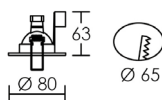

SQUARE

Basculant double orientation



SQUARE 50

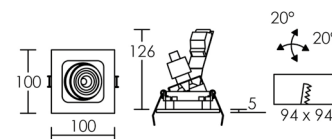

SQUARE 100

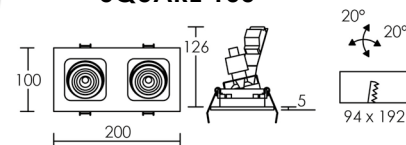

Corps aluminium/Finition aluminium brossé. Double orientation.

Sans lampe - Douille GU10

| P (w) | Douille | Couleur     | Code SQUARE 50 | € HT  | Code SQUARE 100 | € HT  |
|-------|---------|-------------|----------------|-------|-----------------|-------|
| 50    | GU10    | alu. brossé | 4725           | 28,40 | 4726            | 53,00 |

Avec lampe LED GU10 6W



500 lm

| LED 6E | 3000K | 6W | 36° | h (m) | E <sub>max</sub> (lx) | d (m) |
|--------|-------|----|-----|-------|-----------------------|-------|
| ▲      |       |    |     | 1     | 972                   | 0,65  |
|        |       |    |     | 2     | 243                   | 1,3   |
|        |       |    |     | 2,5   | 156                   | 1,6   |

| LED 6E | 4000K | 6W | 36° | h (m) | E <sub>max</sub> (lx) | d (m) |
|--------|-------|----|-----|-------|-----------------------|-------|
| ▲      |       |    |     | 1     | 1035                  | 0,65  |
|        |       |    |     | 2     | 259                   | 1,3   |
|        |       |    |     | 2,5   | 166                   | 1,6   |

36° GU10

| P (w) | Lumens | Teinte   | Code SQUARE 50 | € HT  | Code SQUARE 100 | € HT  |
|-------|--------|----------|----------------|-------|-----------------|-------|
| 6     | 470    | ● 3000 K | 51060          | 33,70 | 51186           | 61,20 |
| 6     | 500    | ○ 4000 K | 51061          | 33,70 | 51187           | 61,20 |

Avec lampe LED GU10 7W



670 lm

| 2997 | 3000K | 7 W | 36° | h (m) | E <sub>max</sub> (lx) | d (m) |
|------|-------|-----|-----|-------|-----------------------|-------|
| ▲    |       |     |     | 1     | 1295                  | 0,65  |
|      |       |     |     | 2     | 324                   | 1,3   |
|      |       |     |     | 2,5   | 207                   | 1,6   |

| 2998 | 4000K | 7 W | 36° | h (m) | E <sub>max</sub> (lx) | d (m) |
|------|-------|-----|-----|-------|-----------------------|-------|
| ▲    |       |     |     | 1     | 1335                  | 0,65  |
|      |       |     |     | 2     | 334                   | 1,3   |
|      |       |     |     | 2,5   | 214                   | 1,6   |

36° GU10

| P (w) | Lumens | Teinte   | Code SQUARE 50 | € HT  | Code SQUARE 100 | € HT  |
|-------|--------|----------|----------------|-------|-----------------|-------|
| 7     | 650    | ● 3000 K | 51062          | 40,30 | 51188           | 65,30 |
| 7     | 670    | ○ 4000 K | 51063          | 40,30 | 51189           | 65,30 |

# QUADRA 110

Basculant double orientation



QUADRA 110

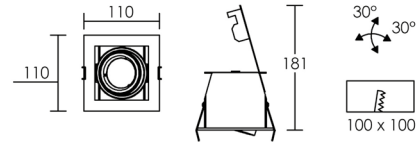

QUADRA 110\_2

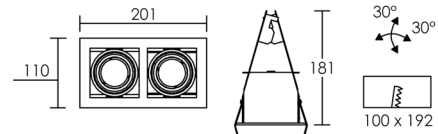

Corps aluminium. Double orientation.

## Sans lampe - Douille GU5,3

| P (w) | Douille | Couleur | Code<br>QUADRA<br>110 | € HT  | Code<br>QUADRA<br>110-2 | € HT  |
|-------|---------|---------|-----------------------|-------|-------------------------|-------|
| 50    | GU5,3   | blanc   | 4170                  | 34,40 | 4171                    | 66,30 |
| 50    | GU5,3   | gris    | 4180                  | 34,40 | 4181                    | 66,30 |

# TOP 0

Basculant

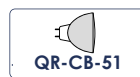

Corps aluminium. Basculant.



| P (w) | Douille | Couleur | Code<br>sans lampe | € HT  |
|-------|---------|---------|--------------------|-------|
| 50    | GU5,3   | gris    | 4311               | 15,30 |

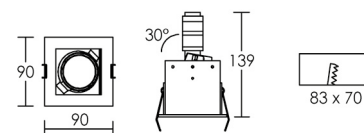

EN 63

Fixe

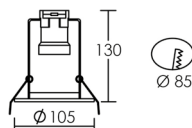

Corps acier. Fixe.

| P (w) | Douille | Couleur | Code sans lampe | € HT  |
|-------|---------|---------|-----------------|-------|
| 60    | E27     | blanc   | 0612            | 12,10 |



MINI SAT

Fixe

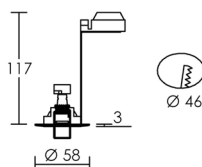

Corps aluminium. Fixe.

| P (w) | Douille | Couleur | Code sans lampe | € HT  |
|-------|---------|---------|-----------------|-------|
| 35    | G4      | blanc   | 4656            | 10,70 |

LUNAR 35

Basculant

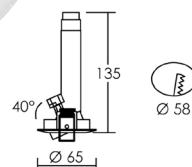

Corps aluminium. Basculant.

| P (w) | Douille | Couleur | Code sans lampe | € HT  |
|-------|---------|---------|-----------------|-------|
| 35    | G4      | blanc   | 4870            | 12,20 |

## LUCIA 1



70 lm

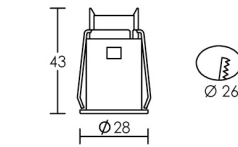

| 5076  | 3000 K         | 1 W   | 25° |
|-------|----------------|-------|-----|
| h (m) | $E_{max}$ (lx) | d (m) |     |
| 0,5   | 1474           | 0,22  |     |
| 1     | 369            | 0,44  |     |
| 2     | 92             | 0,9   |     |

Polycarbonate/Colerette cristal/Dissipateur aluminium. Fixe.

25° 30 000 h

| P (w) | Lumens | Teinte   | Code | € HT  |
|-------|--------|----------|------|-------|
| 1     | 70     | ● 3000 K | 5076 | 38,80 |
| 1     | -      | ● bleu   | 5077 | 38,80 |

### RACCORDEMENT

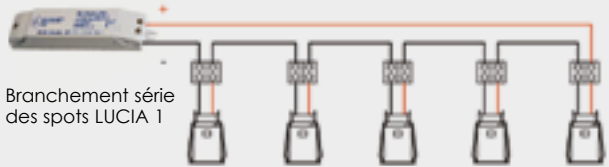

Branchement série des spots LUCIA 1

### ALIMENTATIONS 350 mA

Alimentation courant constant. Bornier à vis.



| P (w) | IP | Code  | € HT  |
|-------|----|-------|-------|
| 4,9   | 20 | 0607  | 28,70 |
| 7,2   | 20 | 52003 | 22,30 |

## LUCIA 2



85 lm

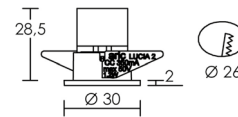

Spot pour vitrine. Polycarbonate gris/Dissipateur aluminium. Fixe. Précâblage 1 m, avec connecteur.

1W 25° 30 000 h

| Faisceau | Lumens | Teinte   | Code | € HT  |
|----------|--------|----------|------|-------|
| 15°      | 85     | ● 3000 K | 5180 | 38,80 |
| 15°      | 85     | ● 5000 K | 5181 | 38,80 |
| 15°      | -      | ● bleu   | 5182 | 38,80 |
| 40°      | 85     | ● 3000 K | 5183 | 38,80 |
| 40°      | 85     | ● 5000 K | 5184 | 38,80 |
| 40°      | -      | ● bleu   | 5185 | 38,80 |



| 5180  | 3000 K         | 1 W   | 15° |
|-------|----------------|-------|-----|
| h (m) | $E_{max}$ (lx) | d (m) |     |
| 1     | 823            | 0,26  |     |
| 2     | 206            | 0,5   |     |
| 2,5   | 132            | 0,7   |     |

| 5181  | 5000 K         | 1 W   | 15° |
|-------|----------------|-------|-----|
| h (m) | $E_{max}$ (lx) | d (m) |     |
| 1     | 823            | 0,26  |     |
| 2     | 206            | 0,5   |     |
| 2,5   | 132            | 0,7   |     |

| 5183  | 3000 K         | 1 W   | 40° |
|-------|----------------|-------|-----|
| h (m) | $E_{max}$ (lx) | d (m) |     |
| 1     | 165            | 0,73  |     |
| 2     | 41             | 1,5   |     |
| 2,5   | 26             | 1,8   |     |

| 5184  | 5000 K         | 1 W   | 40° |
|-------|----------------|-------|-----|
| h (m) | $E_{max}$ (lx) | d (m) |     |
| 1     | 165            | 0,73  |     |
| 2     | 41             | 1,5   |     |
| 2,5   | 26             | 1,8   |     |

### RACCORDEMENT

Alimentation et connexions p. 430

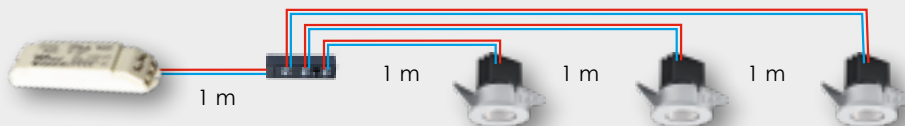

## FLAT 5W



450 lm

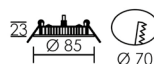

Corps aluminium/Diffuseur PMMA opale. Fixe.  
Alimentation séparée pré-câblée, classe 2, IP20.

5W <math>\triangleleft 110^\circ</math> 35 000 h

| Lumens | Teinte | Couleur | Code  | € HT  |
|--------|--------|---------|-------|-------|
| 400    | 3000 K | blanc   | 50459 | 17,50 |
| 450    | 4000 K | blanc   | 50359 | 17,50 |

| 50459 | 3000K          | 5 W   | 110° |
|-------|----------------|-------|------|
| h (m) | $E_{max}$ (lx) | d (m) |      |
| 1     | 139            | 2,86  |      |
| 2     | 35             | 5,7   |      |
| 2,5   | 22             | 7,1   |      |

| 50359 | 4000K          | 5 W   | 110° |
|-------|----------------|-------|------|
| h (m) | $E_{max}$ (lx) | d (m) |      |
| 1     | 156            | 2,86  |      |
| 2     | 39             | 5,7   |      |
| 2,5   | 25             | 7,1   |      |

## MI 5



520 lm

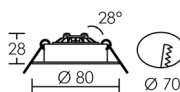

Corps aluminium/Diffuseur polycarbonate cristal. Basculant. Alimentation 128 mA, classe 2, IP20.

5,5W <math>\triangleleft 36^\circ</math> 25 000 h

| Lumens | Teinte | Couleur | Code  | € HT  |
|--------|--------|---------|-------|-------|
| 480    | 3000 K | blanc   | 50431 | 18,10 |
| 520    | 4000 K | blanc   | 50432 | 18,10 |
| 480    | 3000 K | nickel  | 50478 | 18,10 |
| 520    | 4000 K | nickel  | 50479 | 18,10 |

| 50431 | 3000 K         | 5,5 W | 36° |
|-------|----------------|-------|-----|
| h (m) | $E_{max}$ (lx) | d (m) |     |
| 1     | 910            | 0,65  |     |
| 2     | 228            | 1,3   |     |
| 2,5   | 146            | 1,6   |     |

| 50432 | 4000 K         | 5,5 W | 36° |
|-------|----------------|-------|-----|
| h (m) | $E_{max}$ (lx) | d (m) |     |
| 1     | 986            | 0,65  |     |
| 2     | 247            | 1,3   |     |
| 2,5   | 158            | 1,6   |     |

## MI 6



470 lm

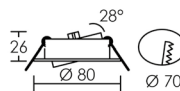

Corps aluminium. Optique en retrait pour un bon confort visuel. Basculant. Alimentation intégrée.

5,5W <math>\triangleleft 40^\circ</math> 25 000 h

| Lumens | Teinte | Couleur | Code  | € HT  |
|--------|--------|---------|-------|-------|
| 450    | 3000 K | blanc   | 50619 | 13,30 |
| 470    | 4000 K | blanc   | 50620 | 13,30 |
| 450    | 3000 K | nickel  | 50621 | 13,30 |
| 470    | 4000 K | nickel  | 50622 | 13,30 |

| 50619 | 3000 K         | 5,5W  | 40° |
|-------|----------------|-------|-----|
| h (m) | $E_{max}$ (lx) | d (m) |     |
| 1     | 727            | 0,73  |     |
| 2     | 182            | 1,5   |     |
| 3     | 81             | 2,2   |     |

| 50620 | 4000 K         | 5,5W  | 40° |
|-------|----------------|-------|-----|
| h (m) | $E_{max}$ (lx) | d (m) |     |
| 1     | 760            | 0,73  |     |
| 2     | 190            | 1,5   |     |
| 3     | 84             | 2,2   |     |

## MICRO LEM



180 lm



Corps aluminium. Fixe. **Raccordement direct en 230V sans alimentation.**

2,5W <math>\angle 40^\circ</math> 30 000 h

| Lumens | Teinte   | Couleur   | Code        | € HT         |
|--------|----------|-----------|-------------|--------------|
| 180    | ○ 4000 K | blanc     | <b>5380</b> | <b>70,40</b> |
| 180    | ○ 4000 K | aluminium | <b>5381</b> | <b>70,40</b> |

| MIC.LEM | 4000k | 2,5W                  | 40°   |
|---------|-------|-----------------------|-------|
|         | h (m) | E <sub>max</sub> (lx) | d (m) |
|         | 1     | <b>352</b>            | 0,73  |
|         | 2     | <b>88</b>             | 1,5   |
|         | 2,5   | <b>56</b>             | 1,8   |

## ACCESSOIRE - DÉTECTEURS (p. 425)



| Code | € HT         |
|------|--------------|
| 1954 | <b>41,40</b> |

## PEARL 2



210 lm



Spot pour vitrine, caisson lumineux. Corps aluminium. Orientable. Précâblage 1,5 m avec connecteur.

2W <math>\angle 18^\circ</math> 30 000 h

| Lumens | Teinte   | Couleur   | Code        | € HT         |
|--------|----------|-----------|-------------|--------------|
| 210    | ● 3000 K | gris alu. | <b>5442</b> | <b>49,00</b> |

| PEARL 2 | 2 w   | 18°         |       |
|---------|-------|-------------|-------|
|         | h (m) | E (lx)      | d (m) |
|         | 0,25  | <b>4166</b> | 0,08  |
|         | 0,5   | <b>1250</b> | 0,16  |
|         | 1     | <b>375</b>  | 0,32  |

## RACCORDEMENT

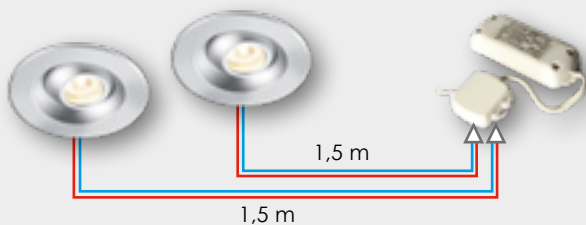

Alimentation Courant Constant 500mA avec connexion 4 départs. Précâblage 1,5 m et connexion sans outil.

| TBT   | P (w) | IP | Code        | € HT         |
|-------|-------|----|-------------|--------------|
| 500mA | 12    | 20 | <b>0984</b> | <b>35,60</b> |

L x l x h : 120 x 40 x 20 mm.

SPARK



Corps aluminium/Diffuseur transparent. Fixe.

Kit 3 spots

300 lm



Kit prêt-à-poser. Précâblage 2,5 m avec connecteur. Précâblage 1,5 m avec connecteur + fiche 2P 6A. Dérivation 4 départs. **Alimentation 350mA, classe 2, IP20, 6W.**

◀ 30° 35 000 h

| P (w) | Lumens | Teinte | Code  | € HT  |
|-------|--------|--------|-------|-------|
| 3     | 3x 100 | 3000 K | 50598 | 82,60 |

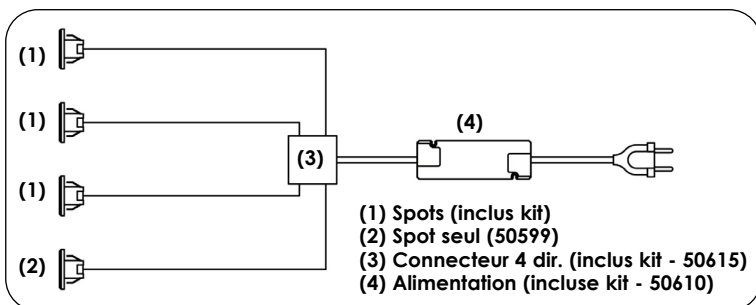

Spot seul

100 lm



A utiliser en complément du kit code 50598. **Spot classe 3, 350mA.**

◀ 30° 35 000 h

| P (w) | Lumens | Teinte | Code  | € HT  |
|-------|--------|--------|-------|-------|
| 1     | 100    | 3000 K | 50599 | 22,40 |

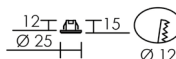

| 50599 | 3000K                 | 1W    | 30° |
|-------|-----------------------|-------|-----|
| h (m) | E <sub>max</sub> (lx) | d (m) |     |
| 0,25  | 5568                  | 0,13  |     |
| 0,5   | 1392                  | 0,3   |     |
| 1     | 348                   | 0,5   |     |

ACCESSOIRES SPARK

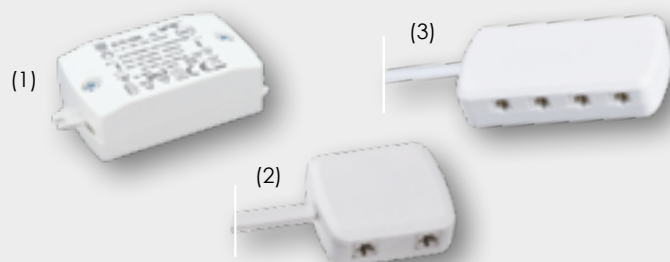

| Désignation                                 | Code  | € HT  |
|---|-------|-------|
| (1) Alimentation du kit 6W 350 mA           | 50610 | 17,30 |
| (2) Connecteur 4 dir. 350 mA                | 50615 | 5,10  |
| (3) Connecteur 8 dir. 350 mA (6 spots max.) | 50639 | 8,20  |



SENSO LED



Corps polycarbonate/Diffuseur opale. Extra plat (7 mm). Fixe.

Kit 2 appliques

600 lm



Kit prêt à poser : 2 spots (1 Maître / 1 Esclave).  
Précâblage 1,5 m avec connecteur. **Alimentation 24V, classe 2, IP20, 15W, précâblée 1,5 m avec connecteur et fiche 2P 6A.**

| ◀ 100° |        | 35 000 h |              |              |
|--------|--------|----------|--------------|--------------|
| P (W)  | Lumens | Teinte   | Code         | € HT         |
| 2x 3,5 | 2x 300 | ☉ 3000 K | <b>50623</b> | <b>80,60</b> |

Dimmer sensible intégré. Fonction mémoire.



Applique seule

300 lm



Spot seul esclave (en complément du kit SENSO LED).  
Spot dimmable uniquement si raccordé au kit **50623**.  
Livré avec câble de jonction 1 Maître / 2 Esclaves (code **50683**).

| ◀ 100° |        | 35 000 h |              |              |
|--------|--------|----------|--------------|--------------|
| P (W)  | Lumens | Teinte   | Code         | € HT         |
| 3,5    | 300    | ☉ 3000 K | <b>50624</b> | <b>30,60</b> |

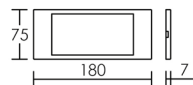
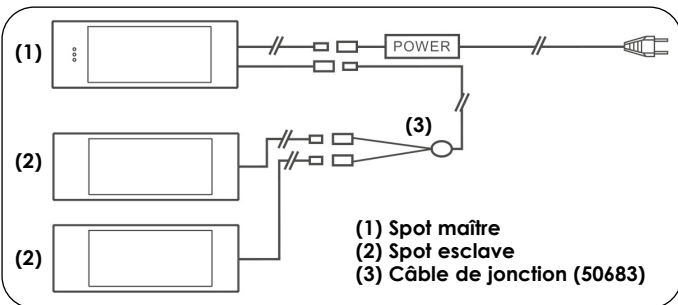

| SENSO | 3000K                 | 3,5 W | 100° |
|-------|-----------------------|-------|------|
| h (m) | E <sub>max</sub> (lx) | d (m) |      |
| 1     | 116                   | 2,38  |      |
| 2     | 29                    | 4,8   |      |
| 3     | 13                    | 7,2   |      |

ACCESSOIRES SENSO LED



| Désignation   | Code         | € HT         |
|---|--------------|--------------|
| (1) Câble d'alimentation                                    | <b>50684</b> | <b>1,20</b>  |
| (2) Alimentation 15W 24V sans connexion                     | <b>52007</b> | <b>26,50</b> |
| (3) Câble de jonction 1 Maître / 2 Esclaves. Longueur 15 cm | <b>50683</b> | <b>2,50</b>  |

MEUBLED 2



Corps polycarbonate/Colerette aluminium/Diffuseur opale. Fixe.

Kit 4 spots

300 lm



Kit prêt-à-poser, 4 spots. Précâblage 2,5 m avec connecteur. Précâblage 1,5 m avec connecteur + fiche 2P 6A. Dérivation 4 départs. **Alimentation 24V, classe 2, IP20, 7,2W.**

4x 1,7W ◀ 110° 35 000 h

| P (w) | Lumens | Teinte   | Code | € HT  |
|-------|--------|----------|------|-------|
| 6,8   | 4x 65  | ● 3000 K | 5365 | 94,90 |
| 6,8   | 4x 75  | ○ 4000 K | 5337 | 94,90 |

Spot seul

75 lm



Précâblage 2,5 m avec connecteur. Spot **Classe 3.**

1,7W ◀ 110° 35 000 h

| IP  | Lumens | Teinte   | Code | € HT  |
|-----|--------|----------|------|-------|
| 20  | 65     | ● 3000 K | 5364 | 19,40 |
| 20  | 75     | ○ 4000 K | 5334 | 19,40 |
| 44* | 65     | ● 3000 K | 5332 | 20,40 |
| 44* | 75     | ○ 4000 K | 5333 | 20,40 |

| MEUBLED 2 | 3000K          | 1,7 W | 110° |
|-----------|----------------|-------|------|
| h (m)     | $E_{max}$ (lx) | d (m) |      |
| 0,25      | 368            | 0,71  |      |
| 0,5       | 92             | 1,4   |      |
| 1         | 23             | 2,9   |      |

| MEUBLED 2 | 4000K          | 1,7 W | 110° |
|-----------|----------------|-------|------|
| h (m)     | $E_{max}$ (lx) | d (m) |      |
| 0,25      | 432            | 0,71  |      |
| 0,5       | 108            | 1,4   |      |
| 1         | 27             | 2,9   |      |

ACCESSOIRES MEUBLED 1 & 2

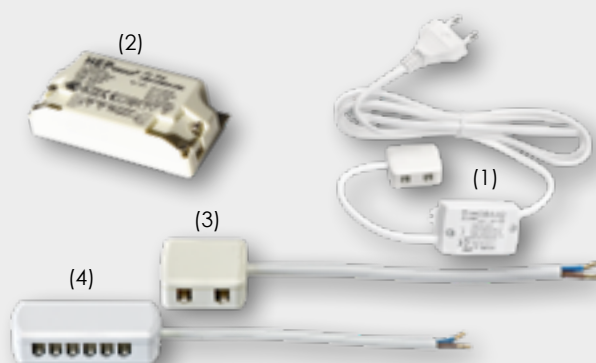

| Désignation  | Code | € HT  |
|--|------|-------|
| (1) Alimentation du kit 7,2W 24V avec connexion MEUBLED* | 0881 | 21,40 |
| (2) Alimentation 12W 24V sans connexion                  | 0697 | 25,10 |
| (3) Connecteur* 4 dir. 24V                               | 0988 | 3,50  |
| (4) Connecteur* 6 dir. 24V                               | 0989 | 4,70  |

\* Connectique identique pour MEUBLED 1 et 2

MEUBLED IP65



Corps polycarbonate/Diffuseur opale. Fixe.

Kit 3 spots

960 lm



Kit prêt à poser : 3 spots, précâblés avec connecteur.  
Alimentation 350mA, classe 2, IP20, 10,5-14W,  
précâblée 1,5 m avec connecteurs (convient pour  
installation 3 ou 4 spots).

◀ 100° 35 000 h

|          | P (w)  | Lumens | Teinte   | Code         | € HT         |
|----------|--------|--------|----------|--------------|--------------|
| <b>N</b> | 3x 3,5 | 3x 320 | ● 3000 K | <b>50843</b> | <b>94,00</b> |
| <b>N</b> | 3x 3,5 | 3x 320 | ○ 4000 K | <b>50844</b> | <b>94,00</b> |

Dimmable par coupure de phase.

Spot seul

320 lm



Spot **Classe 3**.

◀ 100° 35 000 h

|          | P (w) | Lumens | Teinte   | Code         | € HT         |
|----------|-------|--------|----------|--------------|--------------|
| <b>N</b> | 3,5   | 320    | ● 3000 K | <b>50846</b> | <b>22,00</b> |
| <b>N</b> | 3,5   | 320    | ○ 4000 K | <b>50847</b> | <b>22,00</b> |

Dimmable par coupure de phase.

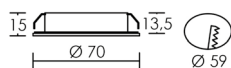

| 50846 | 4000K                 | 3,5W  | 100° |
|-------|-----------------------|-------|------|
| h (m) | E <sub>max</sub> (lx) | d (m) |      |
| 1     | 126                   | 2,38  |      |
| 2     | 32                    | 4,8   |      |
| 3     | 14                    | 7,2   |      |

| 50847 | 4000K                 | 3,5W  | 100° |
|-------|-----------------------|-------|------|
| h (m) | E <sub>max</sub> (lx) | d (m) |      |
| 1     | 126                   | 2,38  |      |
| 2     | 32                    | 4,8   |      |
| 3     | 14                    | 7,2   |      |

ACCESSOIRES MEUBLED IP65

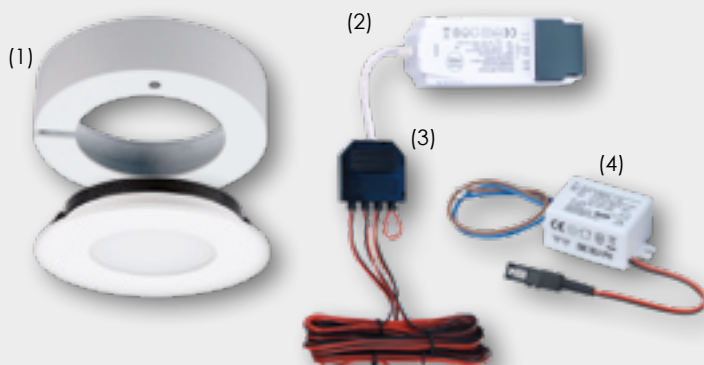

|          | Désignation                                 | Code         | € HT         |
|----------|---|--------------|--------------|
| <b>N</b> | (1) Accessoire montage en saillie blanc     | <b>50845</b> | <b>6,00</b>  |
| <b>N</b> | (2) Driver de remplacement pour kit 3 spots | <b>50848</b> | <b>18,00</b> |
| <b>N</b> | (3) Connectique avec dérivation 4 départs   | <b>50849</b> | <b>7,00</b>  |
| <b>N</b> | (4) Driver pour utilisation spot seul       | <b>52031</b> | <b>12,20</b> |

## S 1200 LED



Corps thermoplastique/Face thermoplastique/Verre de protection. Fixe.



### Kit 3 spots

450 lm



Kit prêt-à-poser, 3 spots.

3x 1,8W  $\angle 70^\circ$  G4 25 000 h

| Lumens | Teinte | Couleur | Code avec lampe | € HT  |
|--------|--------|---------|-----------------|-------|
| 3x 150 | 3000 K | blanc   | 50775           | 67,00 |
| 3x 150 | 3000 K | doré    | 50776           | 73,00 |
| 3x 150 | 3000 K | chromé  | 50777           | 73,00 |

Verre de rechange, code 1661.

### Spot seul

150 lm

| S1200 | 3000K                 | 1,8   | 70° |
|-------|-----------------------|-------|-----|
| h (m) | E <sub>max</sub> (lx) | d (m) |     |
| 1     | 75                    | 1,40  |     |
| 2     | 19                    | 2,8   |     |
| 2,5   | 12                    | 3,5   |     |

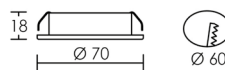

Spot Classe 3.

1,8W  $\angle 70^\circ$  G4 25 000 h

| Lumens | Teinte | Couleur | Code avec lampe | € HT  |
|--------|--------|---------|-----------------|-------|
| 150    | 3000 K | blanc   | 50770           | 16,50 |
| 150    | 3000 K | doré    | 50771           | 18,80 |
| 150    | 3000 K | chromé  | 50772           | 17,80 |

Verre de rechange, code 1661.

## S 307 LED



150 lm



Corps thermoplastique/Face zamak/  
Verre de protection. Fixe.

1,8W  $\angle 70^\circ$  G4 25 000 h

| Lumens | Teinte | Couleur | Code avec lampe | € HT  |
|--------|--------|---------|-----------------|-------|
| 150    | 3000 K | blanc   | 50773           | 20,60 |
| 150    | 3000 K | chromé  | 50774           | 23,50 |

Verre de rechange, code 1661.

| S307  | 3000K                 | 1,8   | 70° |
|-------|-----------------------|-------|-----|
| h (m) | E <sub>max</sub> (lx) | d (m) |     |
| 1     | 75                    | 1,40  |     |
| 2     | 19                    | 2,8   |     |
| 2,5   | 12                    | 3,5   |     |

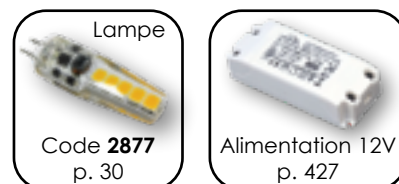
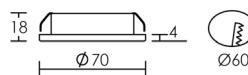

## ACCESSOIRES POUR MEUBLE

## CAPOT



Capot thermoplastique à fixer au-dessus du spot permettant d'obtenir un indice de protection IP23. Installation volumes 2 et 3.

| Couleur | Code | € HT |
|---------|------|------|
| blanc   | 0935 | 2,70 |

Pour panneaux de 15 à 22 mm.



## PRISE MEUBLE



Ø extérieur 80 mm  
Profondeur 50 mm

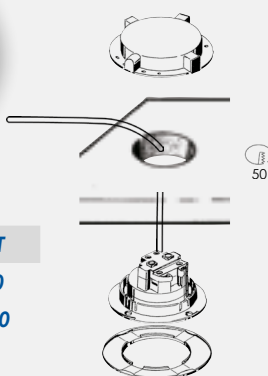

Prise 2x 10/16 A+T

| Couleur | Code | € HT  |
|---------|------|-------|
| blanc   | 1393 | 8,70  |
| chromé  | 1395 | 13,20 |

## INTERRUPTEUR

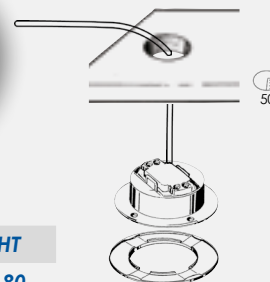

| Couleur | Code | € HT  |
|---------|------|-------|
| blanc   | 1390 | 10,80 |
| chromé  | 1392 | 12,10 |

## INTER SENSITIF



Interrupteur miniature sensible.  
**Fonctionne au passage de la main.**  
Alimentation 230V.

| Référence | Code | € HT  |
|-----------|------|-------|
| HZK-218 C | 1956 | 37,80 |

Installation dans des parois d'épaisseur minimum de 19 mm. Interrupteur de sécurité. Capteur déporté. Câble 1,5 m et connexion sans outil.

## SENSOR PORTE



Boîtier de commande :  
L x l x h : 83 x 35 x 19 mm.



Détecteur d'ouverture de porte.  
**Fonctionne en ouverture ou fermeture de porte.** Alimentation 230V.

| Référence | Code | € HT  |
|-----------|------|-------|
| HZK-218 B | 1955 | 37,80 |

Installation dans des parois d'épaisseur minimum de 19 mm. Capteur déporté. Câble 1,5 m et connexion sans outil.

RUSSEL



52 lm

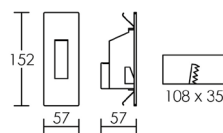

Corps aluminium. Eclairage dirigé vers le sol.  
Alimentation intégrée. **Livré sans boîte d'encastrement.**

1,2W  $\sphericalangle$  100° 25 000 h

| Lumens | Teinte   | Couleur | Code         | € HT         |
|--------|----------|---------|--------------|--------------|
| 52     | ● 3000 K | blanc   | <b>50234</b> | <b>47,90</b> |
| 52     | ○ 4000 K | blanc   | <b>50236</b> | <b>47,90</b> |
| 52     | ● 3000 K | gris    | <b>50235</b> | <b>47,90</b> |
| 52     | ○ 4000 K | gris    | <b>50237</b> | <b>47,90</b> |

| RUSSEL 3-4000K 1,2W 100° |                       |       |  |
|--------------------------|-----------------------|-------|--|
| h (m)                    | E <sub>max</sub> (lx) | d (m) |  |
| 1                        | <b>102</b>            | 0,58  |  |
| 2                        | <b>26</b>             | 1,2   |  |
| 2,5                      | <b>11</b>             | 1,7   |  |

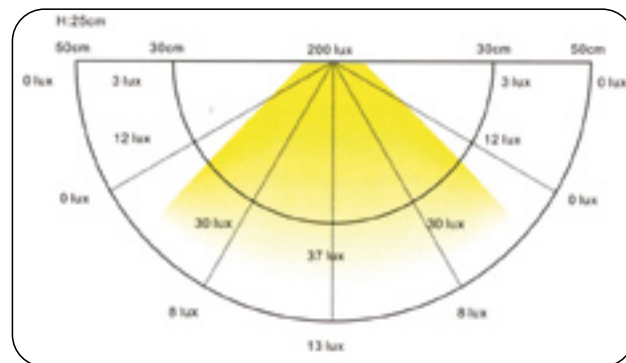
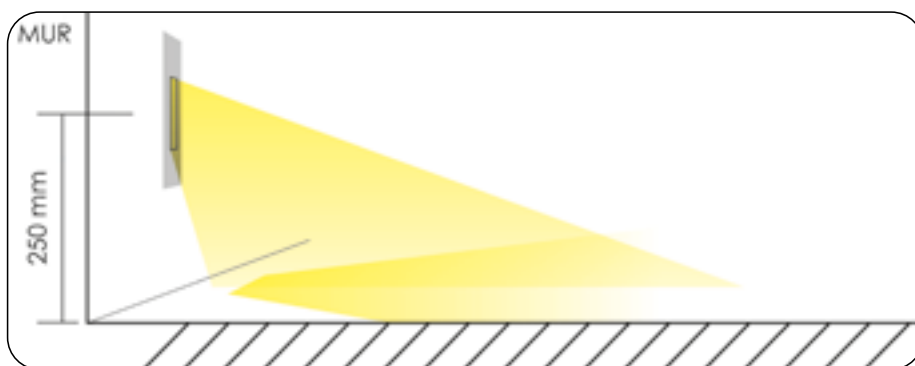

BOÎTE D'ENCASTREMENT RUSSEL

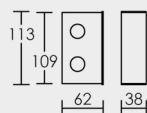

Code **50238** € HT **14,30**

## BALIZ 2



46 lm



Corps métal/Diffuseur polycarbonate. Alimentation intégrée. **Boîte d'encastrement spécifique fournie.**

**0,92W** **30 000 h**

| Lumens | Teinte          | Couleur | Code         | € HT         |
|--------|-----------------|---------|--------------|--------------|
| 32     | ● 2400 K        | blanc   | <b>50261</b> | <b>64,30</b> |
| 46     | ○ 4200 K        | blanc   | <b>50262</b> | <b>64,30</b> |
| -      | ● bleu (465 nm) | blanc   | <b>50381</b> | <b>64,30</b> |

| Lumens | Teinte          | Couleur | Code         | € HT         |
|--------|-----------------|---------|--------------|--------------|
| 32     | ● 2400 K        | gris    | <b>50263</b> | <b>57,10</b> |
| 46     | ○ 4200 K        | gris    | <b>50264</b> | <b>57,10</b> |
| -      | ● bleu (465 nm) | gris    | <b>50382</b> | <b>57,10</b> |

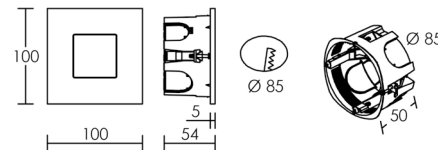

## BALIZ 3



170 lm

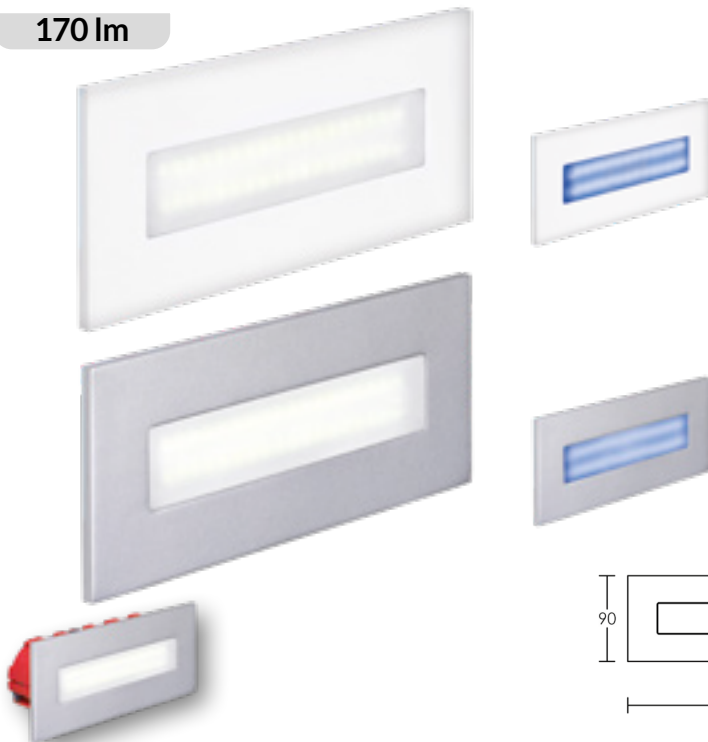

Corps métal/Diffuseur polycarbonate. Alimentation intégrée. **Boîte d'encastrement spécifique fournie.**

**2,76W** **30 000 h**

| Lumens | Teinte          | Couleur | Code         | € HT         |
|--------|-----------------|---------|--------------|--------------|
| 120    | ● 2400 K        | blanc   | <b>50265</b> | <b>79,60</b> |
| 170    | ○ 4200 K        | blanc   | <b>50266</b> | <b>79,60</b> |
| -      | ● bleu (465 nm) | blanc   | <b>50383</b> | <b>79,60</b> |

| Lumens | Teinte          | Couleur | Code         | € HT         |
|--------|-----------------|---------|--------------|--------------|
| 120    | ● 2400 K        | gris    | <b>50267</b> | <b>70,40</b> |
| 170    | ○ 4200 K        | gris    | <b>50268</b> | <b>70,40</b> |
| -      | ● bleu (465 nm) | gris    | <b>50384</b> | <b>70,40</b> |

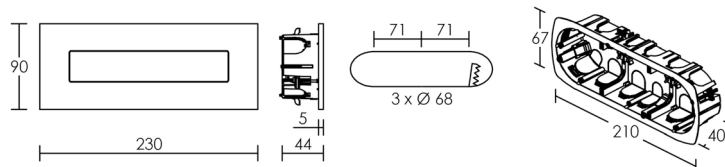

## BALIZ 1



### BALISAGE

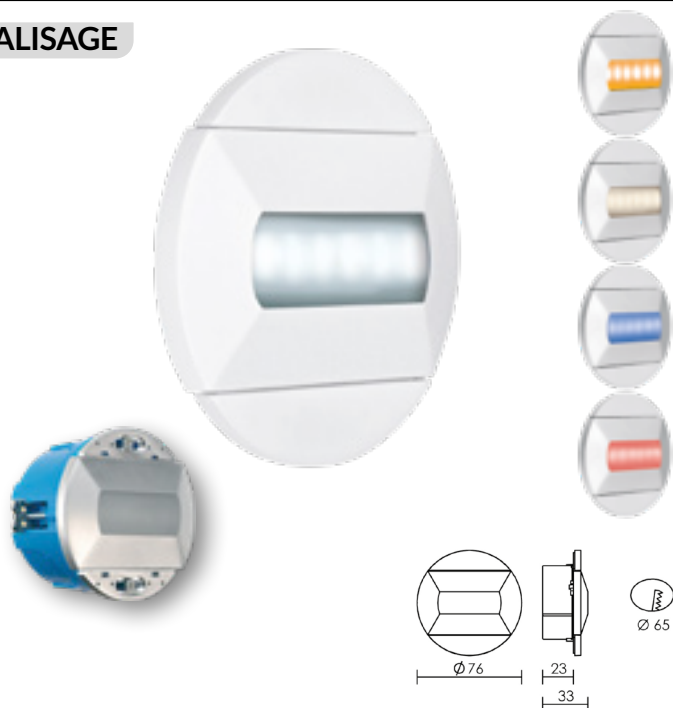

Corps thermoplastique. Alimentation intégrée.  
Boîte d'encastrement spécifique Ø65 mm fournie.

| 30 000 h |                  |         |              |              |
|----------|------------------|---------|--------------|--------------|
| P (w)    | Teinte           | Couleur | Code         | € HT         |
| 0,46     | ● 2400 K         | blanc   | <b>5262</b>  | <b>40,80</b> |
| 0,46     | ○ 3000 K         | blanc   | <b>5242</b>  | <b>40,80</b> |
| 0,46     | ○ 4200 K         | blanc   | <b>5243</b>  | <b>40,80</b> |
| 0,46     | ● bleu (465 nm)  | blanc   | <b>50412</b> | <b>40,80</b> |
| 0,46     | ● rouge (630 nm) | blanc   | <b>50413</b> | <b>40,80</b> |
| 0,46     | ● 2400 K         | gris    | <b>5263</b>  | <b>40,80</b> |
| 0,46     | ○ 3000 K         | gris    | <b>5244</b>  | <b>40,80</b> |
| 0,46     | ○ 4200 K         | gris    | <b>1714</b>  | <b>40,80</b> |
| 0,46     | ● bleu (465 nm)  | gris    | <b>50414</b> | <b>40,80</b> |
| 0,46     | ● rouge (630 nm) | gris    | <b>50415</b> | <b>40,80</b> |

## MURO 1



### BALISAGE



Corps et diffuseur polycarbonate. Précâblage 0,3 m.  
Alimentation intégrée. **Ne nécessite pas de boîte d'encastrement. Installation cloison sèche.**

| 35 000 h |                 |         |             |              |
|----------|-----------------|---------|-------------|--------------|
| P (w)    | Teinte          | Couleur | Code carton | € HT         |
| 0,3      | ○ 5000 K        | chromé  | <b>1764</b> | <b>22,60</b> |
| P (w)    | Teinte          | Couleur | Code V.Pack | € HT         |
| 0,3      | ○ 5000 K        | chromé  | <b>1223</b> | <b>26,10</b> |
| 0,3      | ● bleu (465 nm) | chromé  | <b>1713</b> | <b>26,10</b> |

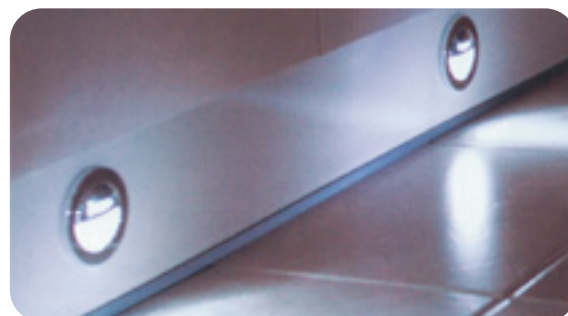



ISO 60



BALISAGE

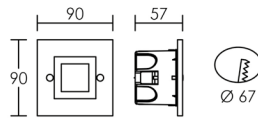

Corps aluminium/Diffuseur polycarbonate.  
Alimentation intégrée. **Boîte d'encastrement Ø60 mm/**  
**Profondeur 50 mm, fournie.**

|       |        |         |             | 75°   | 15 000 h |
|-------|--------|---------|-------------|-------|----------|
| P (w) | Teinte | Couleur | Code carton | € HT  |          |
| 1     | 6500 K | blanc   | 0540        | 30,60 |          |
| 1     | 6500 K | gris    | 0560        | 30,60 |          |

ISO 80



BALISAGE

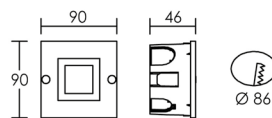

Corps aluminium/Diffuseur polycarbonate.  
Alimentation intégrée. **Boîte d'encastrement Ø80 mm/**  
**Profondeur 40 mm, fournie.**

|       |               |         |             | 75°   | 15 000 h |
|-------|---------------|---------|-------------|-------|----------|
| P (w) | Teinte        | Couleur | Code V.Pack | € HT  |          |
| 1     | 6500 K        | blanc   | 3925        | 38,80 |          |
| 1     | bleu (465 nm) | blanc   | 3926        | 38,80 |          |
| 1     | 6500 K        | gris    | 3928        | 38,80 |          |
| 1     | bleu (465 nm) | gris    | 3929        | 38,80 |          |





## SOMMAIRE | RAIL PROJECTEUR SPOTERIE

### RAILS ET ACCESSOIRES

RAILS 3 ALLUMAGES 230V .....p. 124



RAILS 1 ALLUMAGE 230V .....p. 125



### PROJECTEUR SUR RAIL

IKAR .....p. 126



NINETY .....p. 128



TEK .....p. 130



MENDY .....p. 134



WINDOW .....p. 135



LUMI .....p. 136



ELMA .....p. 138



EVOLI .....p. 140



# SOMMAIRE | RAIL PROJECTEUR SPOTERIE

## SPOTERIE

MICRO LEM...p. 141



JUDY...p. 142



NOLAN...p. 146



RUBIS...p. 148



DIAM...p. 149



COMETE...p. 150



ZAO...p. 152



YEO...p. 153



COSMOS...p. 154



PYXIS...p. 156



ECCO...p. 158



MANTA...p. 160



REMORA...p. 161



TURBO...p. 162



CASA...p. 163



RYBA...p. 163



# RAIL 3 ALLUMAGES 230V (modèle 023)

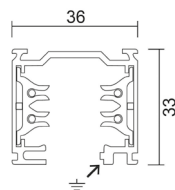
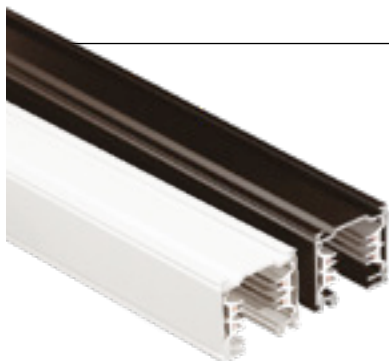

Corps aluminium/4 conducteurs/1 neutre 3 phases + terre - 16A, 3,7 kW.

| L (m) | Code BLANC | € HT   | Code NOIR | € HT   |
|-------|------------|--------|-----------|--------|
| 1     | 16114      | 35,90  | 16113     | 35,90  |
| 2     | 16124      | 71,00  | 16123     | 71,00  |
| 3     | 16134      | 105,30 | 16133     | 105,30 |

### Alimentation droite

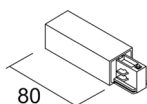

| Coul. | Code  | € HT  |
|-------|-------|-------|
| blanc | 16347 | 14,70 |
| noir  | 16346 | 14,70 |

### Alimentation gauche

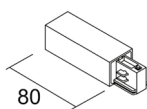

| Coul. | Code  | € HT  |
|-------|-------|-------|
| blanc | 16349 | 14,70 |
| noir  | 16348 | 14,70 |

### Adaptateur

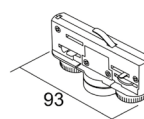

| Coul. | Code  | € HT  |
|-------|-------|-------|
| blanc | 16341 | 17,10 |
| noir  | 16340 | 17,10 |

### Embout de fermeture

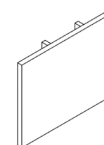

| Coul. | Code  | € HT |
|-------|-------|------|
| blanc | 16355 | 1,60 |
| noir  | 16354 | 1,60 |

### Coude à 90° terre intérieure

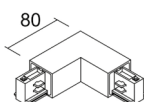

| Coul. | Code  | € HT  |
|-------|-------|-------|
| blanc | 16351 | 31,00 |
| noir  | 16350 | 31,00 |

### Coude à 90° terre extérieure

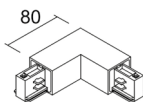

| Coul. | Code  | € HT  |
|-------|-------|-------|
| blanc | 16353 | 31,00 |
| noir  | 16352 | 31,00 |

### Jonction linéaire

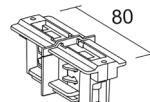

| Coul. | Code  | € HT  |
|-------|-------|-------|
| blanc | 16343 | 10,60 |
| noir  | 16342 | 10,60 |

### Kit suspension

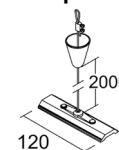

| Coul. | Code  | € HT |
|-------|-------|------|
| blanc | 16345 | 9,00 |
| noir  | 16344 | 9,00 |

### Connexion en T terre droite

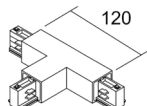

| Coul. | Code  | € HT  |
|-------|-------|-------|
| blanc | 16358 | 48,10 |
| noir  | 16357 | 48,10 |

### Connexion en T terre gauche

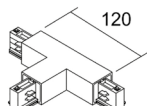

| Coul. | Code  | € HT  |
|-------|-------|-------|
| blanc | 16360 | 48,10 |
| noir  | 16359 | 48,10 |

### Fixation plafond

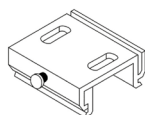

| Code  | € HT |
|-------|------|
| 16356 | 7,30 |

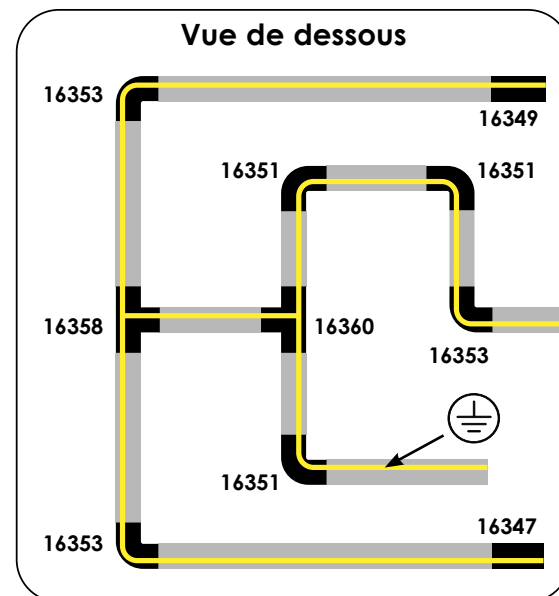

**RAIL 1 ALLUMAGE 230V (modèle 029)**

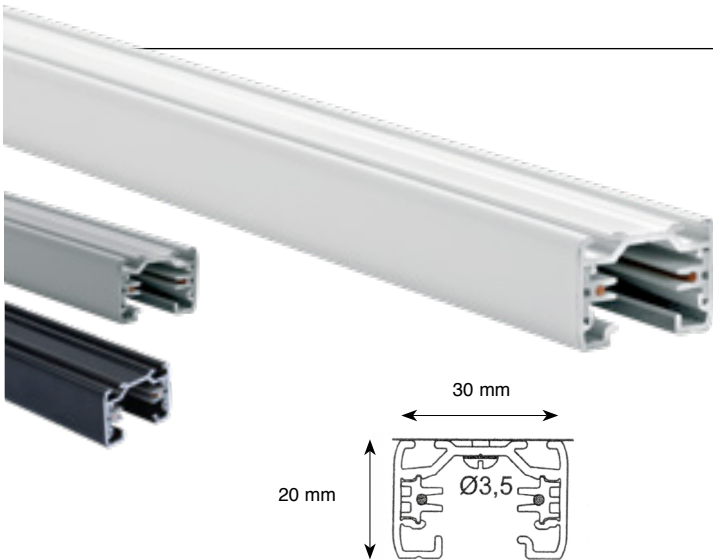

**NOKIA-1 029**

Aluminium. 2 conducteurs 4 mm<sup>2</sup>. 1 neutre/1 phase + terre - 16A, 3,7kW.

| Référence | Long. | Couleur | Code        | € HT         |
|-----------|-------|---------|-------------|--------------|
| GB 2100   | 1 m   | blanc   | <b>1645</b> | <b>36,30</b> |
| GB 2200   | 2 m   | blanc   | <b>1646</b> | <b>72,60</b> |
| GB 2100   | 1 m   | gris    | <b>1613</b> | <b>36,30</b> |
| GB 2200   | 2 m   | gris    | <b>1614</b> | <b>72,60</b> |
| GB 2100   | 1 m   | noir    | <b>1631</b> | <b>36,30</b> |
| GB 2200   | 2 m   | noir    | <b>1632</b> | <b>72,60</b> |

**Alimentation droite**



| Coul. | Code        | € HT         |
|-------|-------------|--------------|
| blanc | <b>1647</b> | <b>12,90</b> |
| noir  | <b>1615</b> | <b>12,90</b> |

**Alimentation gauche**



| Coul. | Code        | € HT         |
|-------|-------------|--------------|
| blanc | <b>1648</b> | <b>12,90</b> |

**Alimentation centrale**



| Coul. | Code        | € HT         |
|-------|-------------|--------------|
| blanc | <b>1649</b> | <b>32,20</b> |
| noir  | <b>1616</b> | <b>32,20</b> |

**Raccord en ligne**



| Coul. | Code        | € HT        |
|-------|-------------|-------------|
| blanc | <b>1650</b> | <b>8,90</b> |
| noir  | <b>1617</b> | <b>8,90</b> |

**Embout fermeture**



| Coul. | Code        | € HT        |
|-------|-------------|-------------|
| blanc | <b>1657</b> | <b>3,20</b> |
| noir  | <b>1620</b> | <b>3,20</b> |

**Raccord orientable**



| Coul. | Code        | € HT         |
|-------|-------------|--------------|
| blanc | <b>1651</b> | <b>51,70</b> |
| noir  | <b>1618</b> | <b>51,70</b> |

**Coude 90° GB 34**



| Coul. | Code        | € HT         |
|-------|-------------|--------------|
| blanc | <b>1652</b> | <b>43,60</b> |

**Raccord en T**



| Réf. | Code        | € HT         |
|------|-------------|--------------|
| GB37 | <b>1653</b> | <b>59,40</b> |
| GB40 | <b>1654</b> | <b>59,40</b> |

**Croix GB 38**



| Coul. | Code        | € HT         |
|-------|-------------|--------------|
| blanc | <b>1655</b> | <b>77,40</b> |

**Suspension**



| Code        | € HT         |
|-------------|--------------|
| <b>1658</b> | <b>29,10</b> |

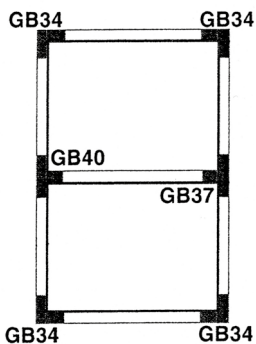

**Raccord fileté**



| Code        | € HT        |
|-------------|-------------|
| <b>1660</b> | <b>4,10</b> |

M 10 pas de 1 mm.

**Adaptateur (> 10 kg)**



| Coul. | Code        | € HT         |
|-------|-------------|--------------|
| blanc | <b>1656</b> | <b>19,40</b> |
| gris  | <b>1619</b> | <b>19,40</b> |
| noir  | <b>1633</b> | <b>19,40</b> |

**Adaptateur (< 10 kg)**



| Coul. | Code        | € HT         |
|-------|-------------|--------------|
| blanc | <b>1606</b> | <b>16,30</b> |
| gris  | <b>1604</b> | <b>16,30</b> |
| noir  | <b>1605</b> | <b>16,30</b> |

**Adaptateur compact (> 10 kg)**



| Coul. | Code         | € HT         |
|-------|--------------|--------------|
| blanc | <b>16100</b> | <b>14,00</b> |
| noir  | <b>16101</b> | <b>14,00</b> |

IKAR



4000 lm

Corps aluminium/Réflecteur à facettes. Alimentation intégrée.

Version 01 - Sur patère

Fixation au plafond uniquement.



40W 4000 lm 50 000 h

| Faisceau | Teinte   | Couleur | Code  | € HT   |
|----------|----------|---------|-------|--------|
| 36°      | ● 3000 K | noir    | 50364 | 199,90 |
| 36°      | ○ 4000 K | noir    | 50365 | 199,90 |
| 60°      | ● 3000 K | noir    | 50366 | 199,90 |
| 60°      | ○ 4000 K | noir    | 50367 | 199,90 |
| 36°      | ● 3000 K | blanc   | 50188 | 199,90 |
| 36°      | ○ 4000 K | blanc   | 50187 | 199,90 |
| 60°      | ● 3000 K | blanc   | 50189 | 199,90 |
| 60°      | ○ 4000 K | blanc   | 50190 | 199,90 |

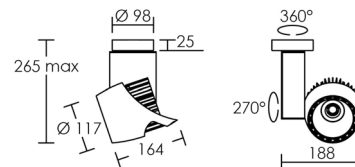

Version 029 - Pour rail 1 allumage (p. 125)

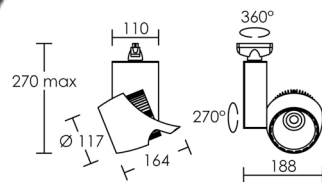

| 40W 4000 lm |        | 50 000 h |              |               |
|-------------|--------|----------|--------------|---------------|
| Faisceau    | Teinte | Couleur  | Code         | € HT          |
| 36°         | 3000 K | blanc    | <b>50176</b> | <b>199,90</b> |
| 36°         | 4000 K | blanc    | <b>50177</b> | <b>199,90</b> |
| 60°         | 3000 K | blanc    | <b>50172</b> | <b>199,90</b> |
| 60°         | 4000 K | blanc    | <b>50173</b> | <b>199,90</b> |
| 36°         | 3000 K | noir     | <b>50326</b> | <b>199,90</b> |
| 36°         | 4000 K | noir     | <b>50327</b> | <b>199,90</b> |
| 60°         | 3000 K | noir     | <b>50322</b> | <b>199,90</b> |
| 60°         | 4000 K | noir     | <b>50323</b> | <b>199,90</b> |

Version 023 - Pour rail 3 allumages (p. 124)

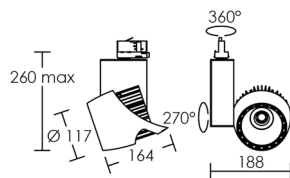

| 40W 4000 lm |        | 50 000 h |              |               |
|-------------|--------|----------|--------------|---------------|
| Faisceau    | Teinte | Couleur  | Code         | € HT          |
| 36°         | 3000 K | blanc    | <b>50178</b> | <b>199,90</b> |
| 36°         | 4000 K | blanc    | <b>50179</b> | <b>199,90</b> |
| 60°         | 3000 K | blanc    | <b>50174</b> | <b>199,90</b> |
| 60°         | 4000 K | blanc    | <b>50175</b> | <b>199,90</b> |
| 36°         | 3000 K | noir     | <b>50328</b> | <b>199,90</b> |
| 36°         | 4000 K | noir     | <b>50329</b> | <b>199,90</b> |
| 60°         | 3000 K | noir     | <b>50324</b> | <b>199,90</b> |
| 60°         | 4000 K | noir     | <b>50325</b> | <b>199,90</b> |

CÔNES GAMME IKAR

| IKAR | 3-4000 K | 40 W                  | 36°   |
|------|----------|-----------------------|-------|
|      | h (m)    | E <sub>max</sub> (lx) | d (m) |
|      | 1        | <b>9111</b>           | 0,65  |
|      | 2        | <b>2278</b>           | 1,3   |
|      | 3        | <b>1012</b>           | 1,9   |
|      | 4        | <b>569</b>            | 2,6   |
|      | 5        | <b>364</b>            | 3,2   |

| IKAR | 3-4000 K | 40 W                  | 60°   |
|------|----------|-----------------------|-------|
|      | h (m)    | E <sub>max</sub> (lx) | d (m) |
|      | 1        | <b>4580</b>           | 1,15  |
|      | 2        | <b>1145</b>           | 2,3   |
|      | 3        | <b>509</b>            | 3,5   |
|      | 4        | <b>286</b>            | 4,6   |
|      | 5        | <b>183</b>            | 5,8   |

NINETY



3000 lm

Corps aluminium noir/Réflecteur à facettes. Alimentation intégrée.

Version 01 - Sur patère



| 30W      | 3000 lm  |         |              | 50 000 h      |
|----------|----------|---------|--------------|---------------|
| Faisceau | Teinte   | Couleur | Code         | € HT          |
| 30°      | ● 3000 K | blanc   | <b>50570</b> | <b>168,30</b> |
| 30°      | ○ 4000 K | blanc   | <b>50571</b> | <b>168,30</b> |
| 70°      | ● 3000 K | blanc   | <b>50572</b> | <b>168,30</b> |
| 70°      | ○ 4000 K | blanc   | <b>50573</b> | <b>168,30</b> |
| 30°      | ● 3000 K | noir    | <b>50574</b> | <b>168,30</b> |
| 30°      | ○ 4000 K | noir    | <b>50575</b> | <b>168,30</b> |
| 70°      | ● 3000 K | noir    | <b>50576</b> | <b>168,30</b> |
| 70°      | ○ 4000 K | noir    | <b>50577</b> | <b>168,30</b> |

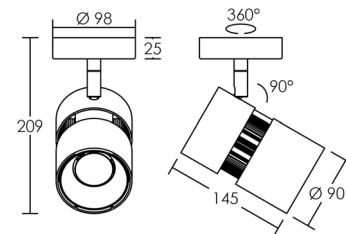

Optique 30°



Optique 70°





Version 029 - Pour rail 1 allumage (p. 125)



| 30W      |        | 3000 lm |              | 50 000 h      |  |
|----------|--------|---------|--------------|---------------|--|
| Faisceau | Teinte | Couleur | Code         | € HT          |  |
| 30°      | 3000 K | blanc   | <b>50578</b> | <b>168,30</b> |  |
| 30°      | 4000 K | blanc   | <b>50579</b> | <b>168,30</b> |  |
| 70°      | 3000 K | blanc   | <b>50580</b> | <b>168,30</b> |  |
| 70°      | 4000 K | blanc   | <b>50581</b> | <b>168,30</b> |  |
| 30°      | 3000 K | noir    | <b>50582</b> | <b>168,30</b> |  |
| 30°      | 4000 K | noir    | <b>50583</b> | <b>168,30</b> |  |
| 70°      | 3000 K | noir    | <b>50584</b> | <b>168,30</b> |  |
| 70°      | 4000 K | noir    | <b>50585</b> | <b>168,30</b> |  |

Version 023 - Pour rail 3 allumages (p. 124)



| 30W      |        | 3000 lm |              | 50 000 h      |  |
|----------|--------|---------|--------------|---------------|--|
| Faisceau | Teinte | Couleur | Code         | € HT          |  |
| 30°      | 3000 K | blanc   | <b>50586</b> | <b>168,30</b> |  |
| 30°      | 4000 K | blanc   | <b>50587</b> | <b>168,30</b> |  |
| 70°      | 3000 K | blanc   | <b>50588</b> | <b>168,30</b> |  |
| 70°      | 4000 K | blanc   | <b>50589</b> | <b>168,30</b> |  |
| 30°      | 3000 K | noir    | <b>50590</b> | <b>168,30</b> |  |
| 30°      | 4000 K | noir    | <b>50591</b> | <b>168,30</b> |  |
| 70°      | 3000 K | noir    | <b>50592</b> | <b>168,30</b> |  |
| 70°      | 4000 K | noir    | <b>50593</b> | <b>168,30</b> |  |

CÔNES GAMME NINETY

| NINETY 3/4000K 30 W 30° |                       |       |  |
|-------------------------|-----------------------|-------|--|
| h (m)                   | E <sub>max</sub> (lx) | d (m) |  |
| 1                       | <b>4763</b>           | 0,54  |  |
| 2                       | <b>1191</b>           | 1,1   |  |
| 3                       | <b>529</b>            | 1,6   |  |

| NINETY 3/4000K 30 W 70° |                       |       |  |
|-------------------------|-----------------------|-------|--|
| h (m)                   | E <sub>max</sub> (lx) | d (m) |  |
| 1                       | <b>2294</b>           | 1,40  |  |
| 2                       | <b>574</b>            | 2,8   |  |
| 3                       | <b>255</b>            | 4,2   |  |

TEK 12



1200 lm

Corps aluminium. Alimentation intégrée.

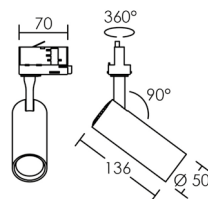
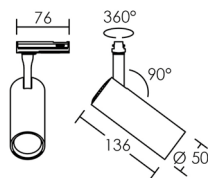

Version 029 - Pour rail 1 allumage (p. 125)



| 12W    |        | 36°     |       | 30 000 h |  |
|--------|--------|---------|-------|----------|--|
| Lumens | Teinte | Couleur | Code  | € HT     |  |
| N 1050 | 3000 K | blanc   | 50920 | 69,00    |  |
| N 1200 | 4000 K | blanc   | 50921 | 69,00    |  |
| N 1050 | 3000 K | noir    | 50922 | 69,00    |  |
| N 1200 | 4000 K | noir    | 50923 | 69,00    |  |



| 12W    |        | 36°     |       | 30 000 h |  |
|--------|--------|---------|-------|----------|--|
| Lumens | Teinte | Couleur | Code  | € HT     |  |
| N 1050 | 3000 K | blanc   | 50924 | 69,00    |  |
| N 1200 | 4000 K | blanc   | 50925 | 69,00    |  |
| N 1050 | 3000 K | noir    | 50926 | 69,00    |  |
| N 1200 | 4000 K | noir    | 50927 | 69,00    |  |

| h (m) | E <sub>max</sub> (lx) | d (m) |
|-------|-----------------------|-------|
| 1     | 2290                  | 0,65  |
| 2     | 573                   | 1,3   |
| 3     | 254                   | 1,9   |
| 4     | 143                   | 2,6   |
| 5     | 92                    | 3,2   |

| h (m) | E <sub>max</sub> (lx) | d (m) |
|-------|-----------------------|-------|
| 1     | 2617                  | 0,65  |
| 2     | 654                   | 1,3   |
| 3     | 291                   | 1,9   |
| 4     | 164                   | 2,6   |
| 5     | 105                   | 3,2   |

TEK 20



2000 lm

Corps aluminium. Alimentation intégrée.

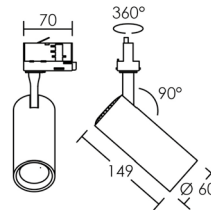
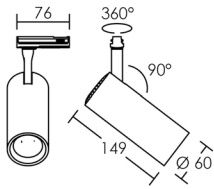

Version 029 - Pour rail 1 allumage (p. 125)

Version 023 - Pour rail 3 allumages (p. 124)



20W ◀ 36° 30 000 h

|          | Lumens | Teinte | Couleur | Code         | € HT         |
|----------|--------|--------|---------|--------------|--------------|
| <b>N</b> | 1900   | 3000 K | blanc   | <b>50928</b> | <b>77,00</b> |
| <b>N</b> | 2000   | 4000 K | blanc   | <b>50929</b> | <b>77,00</b> |
| <b>N</b> | 1900   | 3000 K | noir    | <b>50930</b> | <b>77,00</b> |
| <b>N</b> | 2000   | 4000 K | noir    | <b>50931</b> | <b>77,00</b> |



20W ◀ 36° 30 000 h

|          | Lumens | Teinte | Couleur | Code         | € HT         |
|----------|--------|--------|---------|--------------|--------------|
| <b>N</b> | 1900   | 3000 K | blanc   | <b>50932</b> | <b>77,00</b> |
| <b>N</b> | 2000   | 4000 K | blanc   | <b>50933</b> | <b>77,00</b> |
| <b>N</b> | 1900   | 3000 K | noir    | <b>50934</b> | <b>77,00</b> |
| <b>N</b> | 2000   | 4000 K | noir    | <b>50935</b> | <b>77,00</b> |

| TEK 20 | 3000K                 | 20W   | 36° |
|--------|-----------------------|-------|-----|
| h (m)  | E <sub>max</sub> (lx) | d (m) |     |
| 1      | 3824                  | 0,65  |     |
| 2      | 956                   | 1,3   |     |
| 3      | 425                   | 1,9   |     |
| 4      | 239                   | 2,6   |     |
| 5      | 153                   | 3,2   |     |

| TEK 20 | 4000K                 | 20W   | 36° |
|--------|-----------------------|-------|-----|
| h (m)  | E <sub>max</sub> (lx) | d (m) |     |
| 1      | 4025                  | 0,65  |     |
| 2      | 1006                  | 1,3   |     |
| 3      | 447                   | 1,9   |     |
| 4      | 252                   | 2,6   |     |
| 5      | 161                   | 3,2   |     |

ACCESSOIRES TEK 20W



|          | Désignation   | Couleur | Code         | € HT         |
|----------|---|---------|--------------|--------------|
| <b>N</b> | (1) Filtre "nid d'abeille" pour optimisation du confort | blanc   | <b>50944</b> | <b>11,40</b> |
| <b>N</b> | (2) Filtre "nid d'abeille" pour optimisation du confort | noir    | <b>50945</b> | <b>11,40</b> |
| <b>N</b> | (3) Rallonge (pour réduction du faisceau)               | noir    | <b>50946</b> | <b>9,60</b>  |



TEK 32



3000 lm

Corps aluminium. Alimentation intégrée.



Version 029 - Pour rail 1 allumage (p. 125)

| 1 allum. | 32W    |        | 36°   | 30 000 h |        |
|----------|--------|--------|-------|----------|--------|
|          | Lumens | Teinte |       | Couleur  | Code   |
| (N)      | 3000   | 3000 K | blanc | 50936    | 120,00 |
| (N)      | 3000   | 4000 K | blanc | 50937    | 120,00 |
| (N)      | 3000   | 3000 K | noir  | 50938    | 120,00 |
| (N)      | 3000   | 4000 K | noir  | 50939    | 120,00 |

Version 023 - Pour rail 3 allumages (p. 124)

| 3 allum. | 32W    |        | 36°   | 30 000 h |        |
|----------|--------|--------|-------|----------|--------|
|          | Lumens | Teinte |       | Couleur  | Code   |
| (N)      | 3000   | 3000 K | blanc | 50940    | 120,00 |
| (N)      | 3000   | 4000 K | blanc | 50941    | 120,00 |
| (N)      | 3000   | 3000 K | noir  | 50942    | 120,00 |
| (N)      | 3000   | 4000 K | noir  | 50943    | 120,00 |

| TEK 32 | 3000K                 | 32W   | 36° |
|--------|-----------------------|-------|-----|
| h (m)  | E <sub>max</sub> (lx) | d (m) |     |
| 1      | 6785                  | 0,65  |     |
| 2      | 1696                  | 1,3   |     |
| 3      | 754                   | 1,9   |     |
| 4      | 424                   | 2,6   |     |
| 5      | 271                   | 3,2   |     |

| TEK 32 | 4000K                 | 32W   | 36° |
|--------|-----------------------|-------|-----|
| h (m)  | E <sub>max</sub> (lx) | d (m) |     |
| 1      | 6785                  | 0,65  |     |
| 2      | 1696                  | 1,3   |     |
| 3      | 754                   | 1,9   |     |
| 4      | 424                   | 2,6   |     |
| 5      | 271                   | 3,2   |     |

ACCESSOIRES TEK 32W



|     | Désignation   | Couleur | Code  | € HT  |
|-----|---|---------|-------|-------|
| (N) | (1) Filtre "nid d'abeille" pour optimisation du confort | blanc   | 50947 | 14,60 |
| (N) | (2) Filtre "nid d'abeille" pour optimisation du confort | noir    | 50948 | 14,60 |
| (N) | (3) Rallonge (pour réduction du faisceau)               | noir    | 50949 | 14,60 |

## MENDY 25

Pour rail 3 allumages (p. 124)



2800 lm



Corps aluminium blanc/Réflecteur à facettes.  
Alimentation intégrée.

40° 40 000 h

| P (w) | Lumens | Teinte   | Code         | € HT          |
|-------|--------|----------|--------------|---------------|
| 25,5  | 2800   | ○ 4000 K | <b>50108</b> | <b>193,80</b> |

| h (m) | E <sub>max</sub> (lx) | d (m) |
|-------|-----------------------|-------|
| 1     | <b>5426</b>           | 0,73  |
| 2     | <b>1357</b>           | 1,5   |
| 3     | <b>603</b>            | 2,2   |

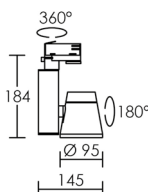

## MENDY 34

Pour rail 3 allumages (p. 124)



3400 lm



Corps aluminium blanc/Réflecteur à facettes.  
Alimentation intégrée.

60° 35 000 h

| P (w) | Lumens | Teinte   | Code         | € HT          |
|-------|--------|----------|--------------|---------------|
| 34    | 3400   | ○ 4000 K | <b>50109</b> | <b>214,20</b> |

| h (m) | E <sub>max</sub> (lx) | d (m) |
|-------|-----------------------|-------|
| 1     | <b>3609</b>           | 1,15  |
| 2     | <b>902</b>            | 2,3   |
| 3     | <b>401</b>            | 3,5   |

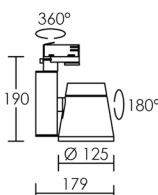

## MENDY 38

Pour rail 3 allumages (p. 124)



4000 lm



Corps aluminium blanc/Réflecteur à facettes.  
Alimentation intégrée.

60° 30 000 h

| P (w) | Lumens | Teinte   | Code         | € HT          |
|-------|--------|----------|--------------|---------------|
| 38    | 4000   | ○ 4000 K | <b>50197</b> | <b>244,80</b> |

| h (m) | E <sub>max</sub> (lx) | d (m) |
|-------|-----------------------|-------|
| 1     | <b>4178</b>           | 1,15  |
| 2     | <b>1045</b>           | 2,3   |
| 3     | <b>464</b>            | 3,5   |

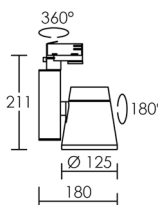

WINDOW



2800 lm

Corps aluminium blanc. Alimentation intégrée.

Version 029 - Pour rail 1 allumage (p. 125)

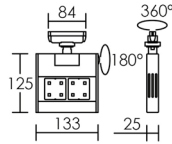

| ◀60°  |        | 30 000 h |              |               |  |
|-------|--------|----------|--------------|---------------|--|
| P (w) | Lumens | Teinte   | Code         | € HT          |  |
| 23    | 2600   | ● 3000 K | <b>50751</b> | <b>168,30</b> |  |
| 23    | 2800   | ○ 4000 K | <b>50752</b> | <b>168,30</b> |  |

Version 023 - Pour rail 3 allumages (p. 124)

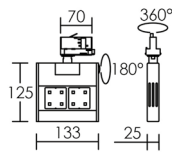

| ◀60°  |        | 30 000 h |              |               |  |
|-------|--------|----------|--------------|---------------|--|
| P (w) | Lumens | Teinte   | Code         | € HT          |  |
| 23    | 2600   | ● 3000 K | <b>50753</b> | <b>168,30</b> |  |
| 23    | 2800   | ○ 4000 K | <b>50754</b> | <b>168,30</b> |  |

| WINDOW | 3000K | 23 W                  | 60°   |
|--------|-------|-----------------------|-------|
| ▲      | h (m) | E <sub>max</sub> (lx) | d (m) |
|        | 1     | <b>2137</b>           | 1,15  |
|        | 2     | <b>534</b>            | 2,3   |
|        | 3     | <b>237</b>            | 3,5   |

| WINDOW | 4000K | 23 W                  | 60°   |
|--------|-------|-----------------------|-------|
| ▲      | h (m) | E <sub>max</sub> (lx) | d (m) |
|        | 1     | <b>2370</b>           | 1,15  |
|        | 2     | <b>593</b>            | 2,3   |
|        | 3     | <b>263</b>            | 3,5   |



LUMI



1800 lm

Corps aluminium/Réflecteur polycarbonate à facettes. Alimentation intégrée.

Version 01 - Sur patère

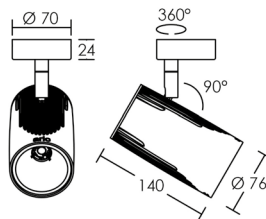

17W ◀ 32° 30 000 h

| Lumens | Teinte   | Couleur | Code         | € HT          |
|--------|----------|---------|--------------|---------------|
| 1800   | ● 3000 K | blanc   | <b>50165</b> | <b>142,80</b> |
| 1800   | ○ 4000 K | blanc   | <b>50167</b> | <b>142,80</b> |
| 1800   | ● 3000 K | noir    | <b>50166</b> | <b>142,80</b> |
| 1800   | ○ 4000 K | noir    | <b>50171</b> | <b>142,80</b> |



Version 029 - Pour rail 1 allumage (p. 125)



17W  $\angle 32^\circ$  30 000 h

| Lumens | Teinte | Couleur | Code         | € HT          |
|--------|--------|---------|--------------|---------------|
| 1800   | 3000 K | blanc   | <b>50182</b> | <b>142,80</b> |
| 1800   | 4000 K | blanc   | <b>50183</b> | <b>142,80</b> |
| 1800   | 3000 K | noir    | <b>50184</b> | <b>142,80</b> |
| 1800   | 4000 K | noir    | <b>50185</b> | <b>142,80</b> |

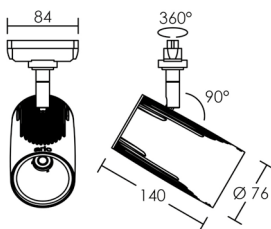

Version 023 - Pour rail 3 allumages (p. 124)



17W  $\angle 32^\circ$  30 000 h

| Lumens | Teinte | Couleur | Code         | € HT          |
|--------|--------|---------|--------------|---------------|
| 1800   | 3000 K | blanc   | <b>50195</b> | <b>142,80</b> |
| 1800   | 4000 K | blanc   | <b>50196</b> | <b>142,80</b> |
| 1800   | 3000 K | noir    | <b>50198</b> | <b>142,80</b> |
| 1800   | 4000 K | noir    | <b>50199</b> | <b>142,80</b> |

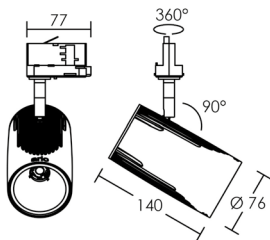

CÔNES GAMME LUMI

| LUMI | 3-4000 K     | 17 W                        | 32°          |
|------|--------------|-----------------------------|--------------|
|      | <b>h (m)</b> | <b>E<sub>max</sub> (lx)</b> | <b>d (m)</b> |
|      | 1            | <b>4518</b>                 | 0,57         |
|      | 2            | <b>1130</b>                 | 1,1          |
|      | 3            | <b>502</b>                  | 1,7          |
|      | 4            | <b>282</b>                  | 2,3          |
|      | 5            | <b>181</b>                  | 2,9          |

| LUMI | 3-4000 K     | 17 W                        | 32°          |
|------|--------------|-----------------------------|--------------|
|      | <b>h (m)</b> | <b>E<sub>max</sub> (lx)</b> | <b>d (m)</b> |
|      | 1            | <b>4518</b>                 | 0,57         |
|      | 2            | <b>1130</b>                 | 1,1          |
|      | 3            | <b>502</b>                  | 1,7          |
|      | 4            | <b>282</b>                  | 2,3          |
|      | 5            | <b>181</b>                  | 2,9          |

ELMA



850 lm

Corps aluminium/Réflecteur à facettes. Alimentation intégrée.

Version 01 - Sur patère

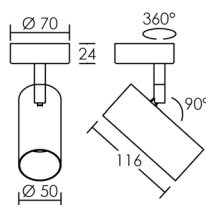

10,5W ◀ 30° 40 000 h

| Lumens | Teinte   | Couleur | Code         | € HT         |
|--------|----------|---------|--------------|--------------|
| 850    | ● 3000 K | blanc   | <b>50467</b> | <b>78,50</b> |
| 850    | ○ 4000 K | blanc   | <b>50468</b> | <b>78,50</b> |
| 850    | ● 3000 K | noir    | <b>50691</b> | <b>78,50</b> |
| 850    | ○ 4000 K | noir    | <b>50692</b> | <b>78,50</b> |

Version 029 - Pour rail 1 allumage (p. 125)



10,5W  $\triangleleft$  30° 40 000 h

| Lumens | Teinte | Couleur | Code         | € HT         |
|--------|--------|---------|--------------|--------------|
| 850    | 3000 K | blanc   | <b>50466</b> | <b>78,50</b> |
| 850    | 4000 K | blanc   | <b>50440</b> | <b>78,50</b> |
| 850    | 3000 K | noir    | <b>50687</b> | <b>78,50</b> |
| 850    | 4000 K | noir    | <b>50688</b> | <b>78,50</b> |

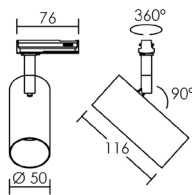

Version 023 - Pour rail 3 allumages (p. 124)



10,5W  $\triangleleft$  30° 40 000 h

| Lumens | Teinte | Couleur | Code         | € HT         |
|--------|--------|---------|--------------|--------------|
| 850    | 3000 K | blanc   | <b>50465</b> | <b>78,50</b> |
| 850    | 4000 K | blanc   | <b>50439</b> | <b>78,50</b> |
| 850    | 3000 K | noir    | <b>50689</b> | <b>78,50</b> |
| 850    | 4000 K | noir    | <b>50690</b> | <b>78,50</b> |

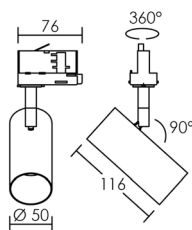

CÔNES GAMME ELMA

| 50466 | 3000K | 10,5W                 | 30°   |
|-------|-------|-----------------------|-------|
|       | h (m) | E <sub>max</sub> (lx) | d (m) |
|       | 1     | 2416                  | 0,54  |
|       | 2     | 604                   | 1,1   |
|       | 3     | 268                   | 1,6   |

| 50440 | 4000K | 10,5W                 | 30°   |
|-------|-------|-----------------------|-------|
|       | h (m) | E <sub>max</sub> (lx) | d (m) |
|       | 1     | 2416                  | 0,54  |
|       | 2     | 604                   | 1,1   |
|       | 3     | 268                   | 1,6   |



820 lm



Corps aluminium noir/Réflecteur plastique aluminisé et protection transparente. **LED COB OSRAM**. Alimentation 500 mA intégrée.

**9W**  $\triangleleft 36^\circ$  **30 000 h**

| Lumens | Teinte   | Couleur | Code         | € HT         |
|--------|----------|---------|--------------|--------------|
| 820    | ● 3000 K | blanc   | <b>50170</b> | <b>80,60</b> |
| 820    | ○ 4000 K | blanc   | <b>50186</b> | <b>80,60</b> |
| 820    | ● 3000 K | noir    | <b>50680</b> | <b>80,60</b> |
| 820    | ○ 4000 K | noir    | <b>50681</b> | <b>80,60</b> |

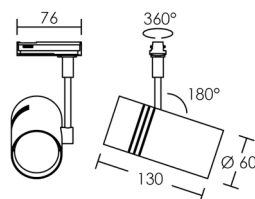

| 50170 | 3000K | 10,5W                 | 36°   |
|-------|-------|-----------------------|-------|
|       | h (m) | E <sub>max</sub> (lx) | d (m) |
|       | 1     | <b>1546</b>           | 0,65  |
|       | 2     | <b>387</b>            | 1,3   |
|       | 3     | <b>172</b>            | 1,9   |

| 50186 | 4000K | 10,5W                 | 36°   |
|-------|-------|-----------------------|-------|
|       | h (m) | E <sub>max</sub> (lx) | d (m) |
|       | 1     | <b>1546</b>           | 0,65  |
|       | 2     | <b>387</b>            | 1,3   |
|       | 3     | <b>172</b>            | 1,9   |

MICRO LEM



Version 01 - Sur patère

180 lm



Corps aluminium. Raccordement direct en 230V sans alimentation.

2,5W ◀ 40° 30 000 h

| Lumens | Teinte   | Couleur   | Code        | € HT         |
|--------|----------|-----------|-------------|--------------|
| 180    | ○ 4000 K | blanc     | <b>5382</b> | <b>90,80</b> |
| 180    | ○ 4000 K | aluminium | <b>5383</b> | <b>90,80</b> |

| MIC.LEM | 4000k                       | 2,5W         | 40° |
|---------|-----------------------------|--------------|-----|
| h (m)   | <b>E<sub>max</sub> (lx)</b> | <b>d (m)</b> |     |
| 1       | <b>352</b>                  | 0,73         |     |
| 2       | <b>88</b>                   | 1,5          |     |
| 2,5     | <b>56</b>                   | 1,8          |     |

Version 029 - Pour rail 1 allumage (p. 125)

180 lm

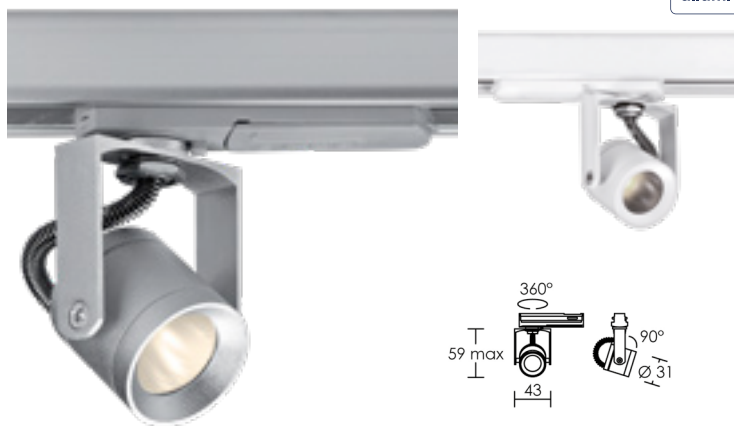

Corps aluminium, avec adaptateur.

2,5W ◀ 40° 30 000 h

| Lumens | Teinte   | Couleur   | Code        | € HT         |
|--------|----------|-----------|-------------|--------------|
| 180    | ○ 4000 K | blanc     | <b>5384</b> | <b>90,80</b> |
| 180    | ○ 4000 K | aluminium | <b>5385</b> | <b>90,80</b> |

| MIC.LEM | 4000k                       | 2,5W         | 40° |
|---------|-----------------------------|--------------|-----|
| h (m)   | <b>E<sub>max</sub> (lx)</b> | <b>d (m)</b> |     |
| 1       | <b>352</b>                  | 0,73         |     |
| 2       | <b>88</b>                   | 1,5          |     |
| 2,5     | <b>56</b>                   | 1,8          |     |

Kit 3 spots - Avec rail 1 allumage

540 lm



Kit rail prêt-à-poser. 3 spots aluminium. Rail 1 allumage monophasé **longueur 1 m.**

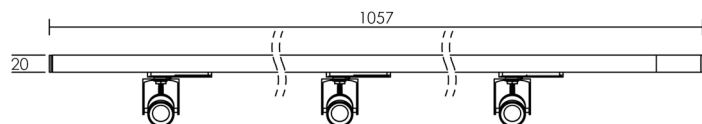

7,5W ◀ 40° 30 000 h

| Lumens | Teinte   | Couleur | Code        | € HT          |
|--------|----------|---------|-------------|---------------|
| 540    | ○ 4000 K | blanc   | <b>5387</b> | <b>300,90</b> |

JUDY - LED DIMMABLE 5,5



Corps polycarbonate. Lampes LED dimmables fournies.

Version 01 - Sur patère

410 lm

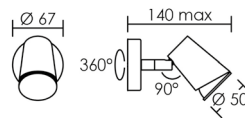

5,5W ◀ 36° GU10 15 000 h

| Lumens | Teinte | Couleur | Code | € HT  |
|--------|--------|---------|------|-------|
| 410    | 3000 K | blanc   | 4148 | 36,70 |
| 410    | 3000 K | noir    | 4159 | 36,70 |

Dimmable par coupure de fin de phase.

Version P3 - Plafonnier 3 spots

1230 lm

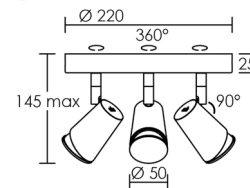

3x 5,5W ◀ 36° GU10 15 000 h

| Lumens | Teinte | Couleur | Code | € HT   |
|--------|--------|---------|------|--------|
| 3x 410 | 3000 K | blanc   | 4151 | 113,20 |
| 3x 410 | 3000 K | noir    | 4162 | 113,20 |

Dimmable par coupure de fin de phase.

Version B3 - Barre 3 spots

1230 lm

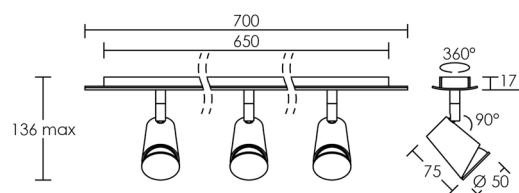

3x 5,5W ◀ 36° GU10 15 000 h

| Lumens | Teinte | Couleur | Code | € HT   |
|--------|--------|---------|------|--------|
| 3x 410 | 3000 K | blanc   | 4150 | 131,60 |
| 3x 410 | 3000 K | noir    | 4161 | 131,60 |

Dimmable par coupure de fin de phase.

## KIT JUDY rail - LED DIMMABLE 5,5



Corps polycarbonate. Lampes LED dimmables fournies.

## Kit 3 spots - Avec rail 1 allumage

1230 lm



Kit rail 1 allumage monophasé NOKIA 1 prêt-à-posers. Longueur 1 m,

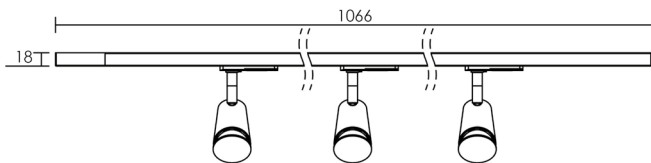

3x 5,5W  $\angle 36^\circ$  GU10 15 000 h

| Lumens | Teinte | Couleur | Code | € HT   |
|--------|--------|---------|------|--------|
| 3x 410 | 3000 K | blanc   | 4157 | 198,90 |
| 3x 410 | 3000 K | noir    | 4163 | 198,90 |

Dimmable par coupure de fin de phase.

## Kit 4 spots - Avec 2 rails 1 allumage

1640 lm



Kit 2 rails 1 allumage monophasé NOKIA 1 prêt-à-posers. Longueur 2x1 m,

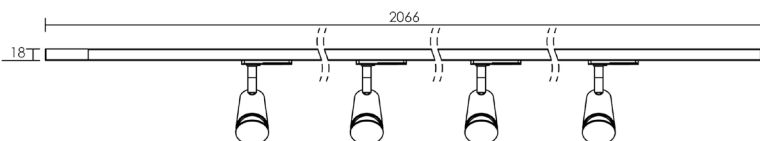

4x 5,5W  $\angle 36^\circ$  GU10 15 000 h

| Lumens | Teinte | Couleur | Code | € HT   |
|--------|--------|---------|------|--------|
| 4x 410 | 3000 K | blanc   | 4158 | 298,90 |
| 4x 410 | 3000 K | noir    | 4164 | 298,90 |

Dimmable par coupure de fin de phase.

JUDY rail - LED DIMMABLE 5,5

Pour rail 1 allumage (p. 125)



410 lm

Corps polycarbonate. Lampes LED dimmables fournies.

Version 029

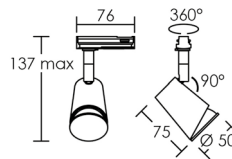

5,5W <math>\triangleleft 36^\circ</math> GU10 15 000 h

| Lumens | Teinte | Couleur | Code | € HT  |
|--------|--------|---------|------|-------|
| 410    | 3000 K | blanc   | 4149 | 49,00 |
| 410    | 3000 K | noir    | 4160 | 49,00 |

Dimmable par coupure de fin de phase.

Version 129

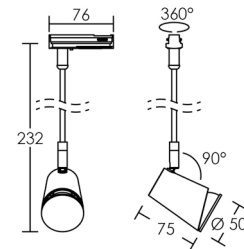

5,5W <math>\triangleleft 36^\circ</math> GU10 15 000 h

| Lumens | Teinte | Couleur | Code | € HT  |
|--------|--------|---------|------|-------|
| 410    | 3000 K | blanc   | 4385 | 55,00 |
| 410    | 3000 K | noir    | 4386 | 55,00 |

Dimmable par coupure de fin de phase.

Version 229

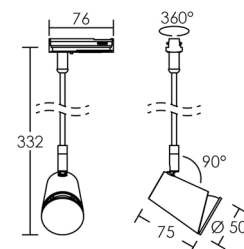
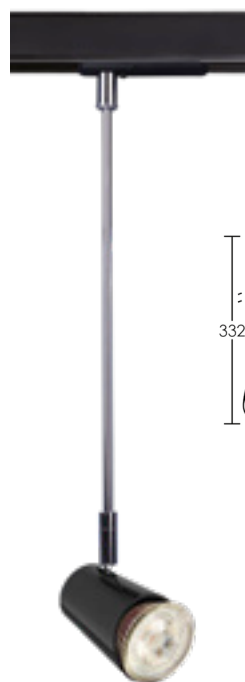

5,5W <math>\triangleleft 36^\circ</math> GU10 15 000 h

| Lumens | Teinte | Couleur | Code | € HT  |
|--------|--------|---------|------|-------|
| 410    | 3000 K | blanc   | 4387 | 65,00 |
| 410    | 3000 K | noir    | 4388 | 65,00 |

Dimmable par coupure de fin de phase.



## JUDY EXPO - LED DIMMABLE 5,5



410 lm



Corps polycarbonate. Lampes LED dimmables fournies.

5,5W  $\triangleleft$  36° GU10 15 000 h

|          | Lumens | Teinte | Couleur | Code        | € HT         |
|----------|--------|--------|---------|-------------|--------------|
| <b>N</b> | 410    | 3000 K | blanc   | <b>4389</b> | <b>76,00</b> |
| <b>N</b> | 410    | 3000 K | noir    | <b>4390</b> | <b>76,00</b> |

Dimmable par coupure de fin de phase.

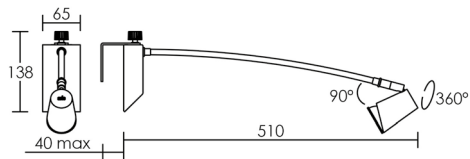

| GLASS | 3000K          | 5,5 W | 36° |
|-------|----------------|-------|-----|
| h (m) | $E_{max}$ (lx) | d (m) |     |
| 1     | <b>692</b>     | 0,65  |     |
| 2     | <b>173</b>     | 1,3   |     |
| 2,5   | <b>111</b>     | 1,6   |     |



## NOLAN - LED DIMMABLE 5,5



Corps aluminium blanc/Réflecteur polycarbonate noir. Lampes LED dimmables fournies.

## Version 01 - Sur patère

355 lm

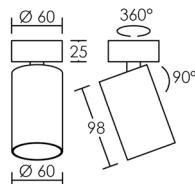

36° GU10 15 000 h

| P (w) | Lumens | Teinte | Code  | € HT  |
|-------|--------|--------|-------|-------|
| 5,5   | 355    | 3000 K | 50672 | 40,80 |
| 5,5   | 355    | 4000 K | 50673 | 40,80 |

Dimmable par coupure de fin de phase.

## Version 029 - Pour rail 1 allumage (p. 125)

355 lm

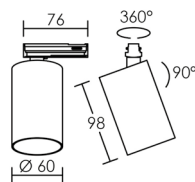

36° GU10 15 000 h

| P (w) | Lumens | Teinte | Code  | € HT  |
|-------|--------|--------|-------|-------|
| 5,5   | 355    | 3000 K | 50674 | 42,80 |
| 5,5   | 355    | 4000 K | 50675 | 42,80 |

Dimmable par coupure de fin de phase.

## Version B1 - Sur patère barre

355 lm

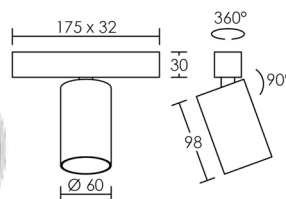

36° GU10 15 000 h

| P (w) | Lumens | Teinte | Code  | € HT  |
|-------|--------|--------|-------|-------|
| 5,5   | 355    | 3000 K | 50676 | 43,90 |
| 5,5   | 355    | 4000 K | 50677 | 43,90 |

Dimmable par coupure de fin de phase.

Version B2 - Sur patère barre 2 spots

710 lm

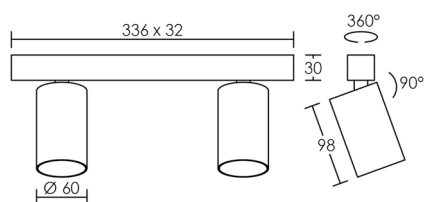
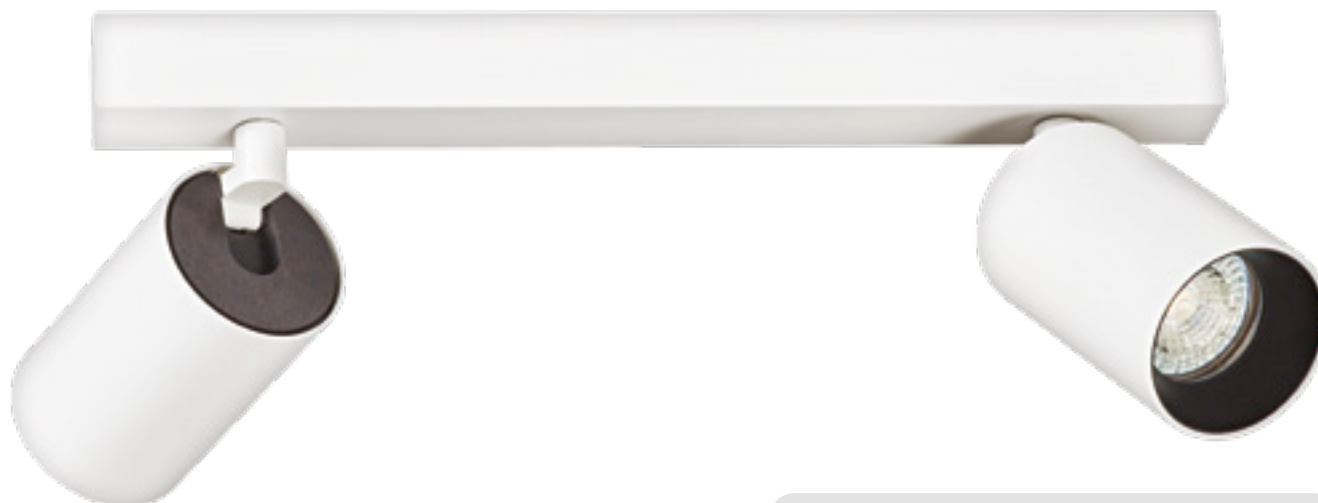

| 36° GU10 |        | 15 000 h |              |              |
|----------|--------|----------|--------------|--------------|
| P (W)    | Lumens | Teinte   | Code         | € HT         |
| 2x 5,5   | 2x 355 | ● 3000 K | <b>50678</b> | <b>81,60</b> |
| 2x 5,5   | 2x 355 | ○ 4000 K | <b>50679</b> | <b>81,60</b> |

Dimmable par coupure de fin de phase.

CÔNES GAMME NOLAN

| NOLAN | 3000K | 5,5W                  | 36°   |
|-------|-------|-----------------------|-------|
|       | h (m) | E <sub>max</sub> (lx) | d (m) |
|       | 1     | 600                   | 0,65  |
|       | 2     | 150                   | 1,3   |
|       | 3     | 67                    | 1,9   |

| NOLAN | 4000K | 5,5W                  | 36°   |
|-------|-------|-----------------------|-------|
|       | h (m) | E <sub>max</sub> (lx) | d (m) |
|       | 1     | 600                   | 0,65  |
|       | 2     | 150                   | 1,3   |
|       | 3     | 67                    | 1,9   |

Gamme NOLAN



✓ Confort visuel  
Optique en retrait



✓ Facilité d'installation  
Corps dévissable

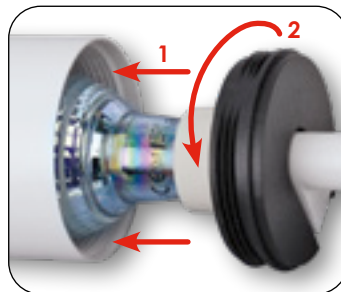

✓ Lampe LED dimmable  
fournie



RUBIS - LED 6



500 lm

Corps aluminium. Lampe LED fournie.

Version 01 - Sur patère



Patère acier.

| 6W     | 36°    | GU10    | 15 000 h |       |
|--------|--------|---------|----------|-------|
| Lumens | Teinte | Couleur | Code     | € HT  |
| 500    | 3000 K | blanc   | 1373     | 38,30 |
| 500    | 3000 K | gris    | 1300     | 38,30 |

Version 029 - Pour rail 1 allumage (p. 125)



| 6W     | 36°    | GU10    | 15 000 h |       |
|--------|--------|---------|----------|-------|
| Lumens | Teinte | Couleur | Code     | € HT  |
| 500    | 3000 K | blanc   | 0260     | 50,20 |
| 500    | 3000 K | gris    | 0324     | 49,70 |



GLASS LED GU10



✓ Cône pour lampe 3000 K

| GLASS | 3000K                 | 6W    | 36° |
|-------|-----------------------|-------|-----|
| h (m) | E <sub>max</sub> (lx) | d (m) |     |
| 1     | 888                   | 0,65  |     |
| 2     | 222                   | 1,3   |     |
| 3     | 99                    | 1,9   |     |

✓ Corps translucide  
✓ Diffuseur cristal



✓ Dimensions identiques à l'halogène

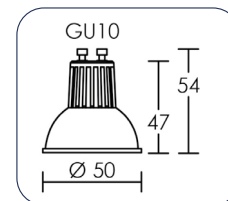

DIAM - LED 6



Corps aluminium/Verre. Lampe LED fournie.

Version 01 - Sur patère

500 lm



Patère acier.

| 6W     | 36°    | GU10    | 15 000 h |       |
|--------|--------|---------|----------|-------|
| Lumens | Teinte | Couleur | Code     | € HT  |
| 500    | 3000 K | blanc   | 1381     | 38,30 |
| 500    | 3000 K | gris    | 0451     | 38,30 |

Verre de rechange, code 1146.

Version 029 - Pour rail 1 allumage (p. 125)

500 lm



| 6W     | 36°    | GU10    | 15 000 h |       |
|--------|--------|---------|----------|-------|
| Lumens | Teinte | Couleur | Code     | € HT  |
| 500    | 3000 K | blanc   | 0261     | 50,20 |
| 500    | 3000 K | gris    | 0325     | 49,70 |

Verre de rechange, code 1146.

Kit 3 spots - Avec rail 1 allumage

1500 lm



Kit rail 1 allumage monophasé NOKIA 1 prêt-à-poser. Longueur 1 m.

| 3x 6W  | 36°    | GU10    | 15 000 h |        |
|--------|--------|---------|----------|--------|
| Lumens | Teinte | Couleur | Code     | € HT   |
| 3x 500 | 3000 K | blanc   | 1176     | 203,20 |

Verre de rechange, code 1146.

Kit 4 spots - Avec 2 rails 1 allumage

2000 lm

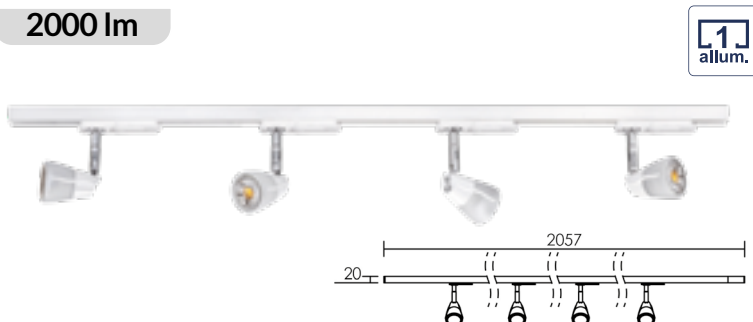

Kit 2 rails 1 allumage blanc monophasé NOKIA 1 prêt-à-poser. Longueur 2x1 m.

| 4x 6W  | 36°    | GU10    | 15 000 h |        |
|--------|--------|---------|----------|--------|
| Lumens | Teinte | Couleur | Code     | € HT   |
| 4x 500 | 3000 K | blanc   | 1197     | 304,90 |

Verre de rechange, code 1146.

COMETE patère - LED 6



Corps aluminium/Patère acier. Lampes LED fournies.

Version 01 - Sur patère

500 lm



| Lumens | Teinte | Couleur | Code | € HT  |
|--------|--------|---------|------|-------|
| 500    | 3000 K | blanc   | 0428 | 50,80 |
| 500    | 3000 K | doré    | 0429 | 78,50 |

Version B2 - Sur patère barre 2 spots

1000 lm

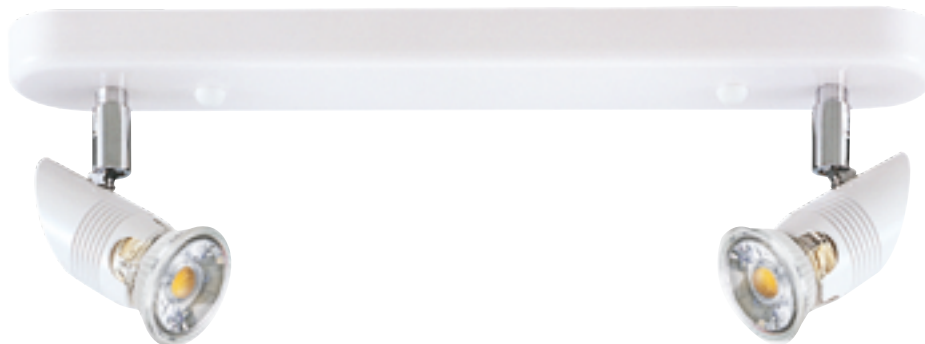

| Lumens | Teinte | Couleur | Code | € HT  |
|--------|--------|---------|------|-------|
| 2x 500 | 3000 K | blanc   | 0441 | 87,70 |

Version B3 - Sur patère barre 3 spots

1500 lm



| Lumens | Teinte | Couleur | Code | € HT   |
|--------|--------|---------|------|--------|
| 3x 500 | 3000 K | blanc   | 0442 | 125,50 |

## COMETE rail - LED 6



Corps aluminium. Lampes LED fournies.

## Version 029 - Pour rail 1 allumage (p. 125)

500 lm

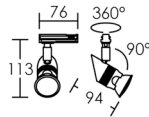
6W  $\triangleleft$  36° GU10 15 000 h

| Lumens | Teinte | Couleur | Code | € HT  |
|--------|--------|---------|------|-------|
| 500    | 3000 K | blanc   | 1277 | 61,20 |

## Version 129 - Pour rail 1 allumage (p. 125)

500 lm

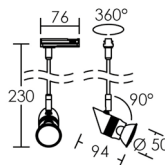
6W  $\triangleleft$  36° GU10 15 000 h

| Lumens | Teinte | Couleur | Code | € HT  |
|--------|--------|---------|------|-------|
| 500    | 3000 K | blanc   | 1278 | 66,30 |

## Kit 3 spots - Avec rail 1 allumage

1500 lm

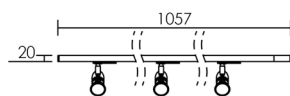

Kit rail 1 allumage monophasé NOKIA 1 prêt-à-poser. Longueur 1 m,

3x 6W  $\triangleleft$  36° GU10 15 000 h

| Lumens | Teinte | Couleur | Code | € HT   |
|--------|--------|---------|------|--------|
| 3x 500 | 3000 K | blanc   | 0326 | 217,30 |

## Kit 4 spots - Avec 2 rails 1 allumage

2000 lm

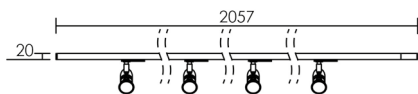

Kit 2 rails 1 allumage monophasé NOKIA 1 prêt-à-poser. Longueur 2x 1 m,

4x 6W  $\triangleleft$  36° GU10 15 000 h

| Lumens | Teinte | Couleur | Code | € HT   |
|--------|--------|---------|------|--------|
| 4x 500 | 3000 K | blanc   | 0327 | 307,00 |

ZAO - LED 6



Corps aluminium blanc. Lampes LED fournies.

Version 01 - Sur patère

500 lm

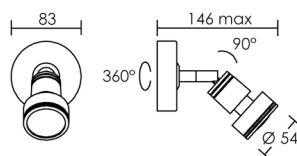

Patère acier.

|       |        |          |      |          |
|-------|--------|----------|------|----------|
|       | ◀ 36°  | GU10     |      | 15 000 h |
| P (w) | Lumens | Teinte   | Code | € HT     |
| 6     | 500    | ● 3000 K | 0221 | 39,20    |

Version 029 - Pour rail 1 allumage (p. 125)

500 lm

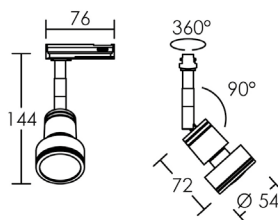

|       |        |          |      |          |
|-------|--------|----------|------|----------|
|       | ◀ 36°  | GU10     |      | 15 000 h |
| P (w) | Lumens | Teinte   | Code | € HT     |
| 6     | 500    | ● 3000 K | 0222 | 55,30    |

Kit 3 spots - Avec rail 1 allumage

1500 lm

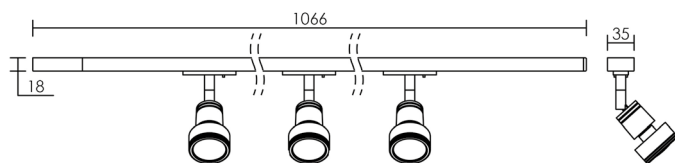

Kit rail 1 allumage monophasé spécifique prêt-à-poser. Longueur 1 m.

|       |        |          |      |          |
|-------|--------|----------|------|----------|
|       | ◀ 36°  | GU10     |      | 15 000 h |
| P (w) | Lumens | Teinte   | Code | € HT     |
| 3x 6  | 3x 500 | ● 3000 K | 0257 | 138,10   |

Spot supplémentaire, code 0258.



## YEO - LED 6



Corps aluminium blanc. Lampes LED fournies.

## Version 01 - Sur patère

500 lm

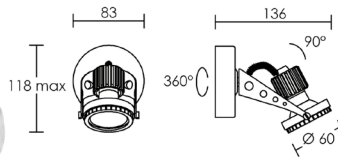

Patère acier.

| P (w) | Lumens | Teinte | Code | € HT  |
|-------|--------|--------|------|-------|
| 6     | 500    | 3000 K | 0238 | 44,20 |

## Version 029 - Pour rail 1 allumage (p. 125)

500 lm

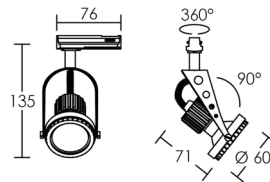

| P (w) | Lumens | Teinte | Code | € HT  |
|-------|--------|--------|------|-------|
| 6     | 500    | 3000 K | 0268 | 64,00 |

## Kit 3 spots - Avec rail 1 allumage

1500 lm

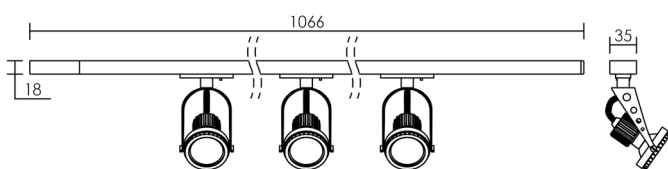

Kit rail 1 allumage monophasé spécifique prêt-à-posier. Longueur 1 m.

| P (w) | Lumens | Teinte | Code | € HT   |
|-------|--------|--------|------|--------|
| 3x 6  | 3x 500 | 3000 K | 0284 | 157,70 |

Spot supplémentaire code 0269.

**COSMOS patère - LED 6**



Corps aluminium blanc/Patère. Lampes LED fournies.

**Version 01 - Sur patère**

**500 lm**

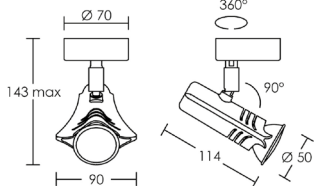

| ◀ 36° GU10 |        |        |      | 15 000 h |
|------------|--------|--------|------|----------|
| P (w)      | Lumens | Teinte | Code | € HT     |
| 6          | 500    | 3000 K | 0406 | 71,80    |

**Version B2 - Sur patère barre 2 spots**

**1000 lm**

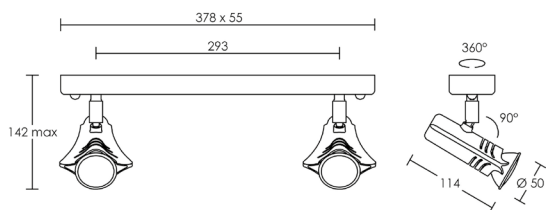

| ◀ 36° GU10 |        |        |      | 15 000 h |
|------------|--------|--------|------|----------|
| P (w)      | Lumens | Teinte | Code | € HT     |
| 2x 6       | 2x 500 | 3000 K | 0578 | 121,10   |

**Version B3 - Sur patère barre 3 spots**

**1500 lm**

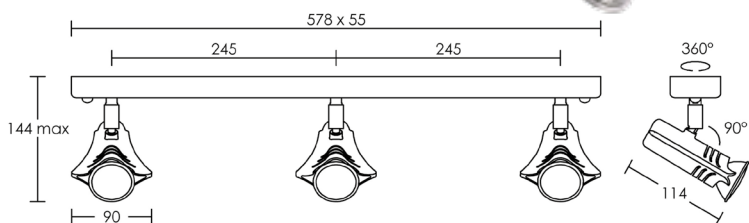

| ◀ 36° GU10 |        |        |      | 15 000 h |
|------------|--------|--------|------|----------|
| P (w)      | Lumens | Teinte | Code | € HT     |
| 3x 6       | 3x 500 | 3000 K | 0579 | 175,40   |

## COSMOS rail - LED 6



500 lm

Corps aluminium blanc. Lampes LED fournies.

## Version 029 - Pour rail 1 allumage (p. 125)



| ◀ 36° |        | GU10     | 15 000 h |       |  |
|-------|--------|----------|----------|-------|--|
| P (W) | Lumens | Teinte   | Code     | € HT  |  |
| 6     | 500    | ● 3000 K | 1276     | 88,80 |  |

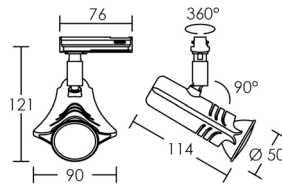

## Version 023 - Pour rail 3 allumages (p. 124)



| ◀ 36° |        | GU10     | 15 000 h |       |  |
|-------|--------|----------|----------|-------|--|
| P (W) | Lumens | Teinte   | Code     | € HT  |  |
| 6     | 500    | ● 3000 K | 0408     | 78,70 |  |

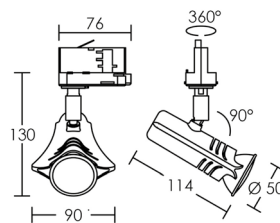

**PYXIS patère - LED 6**



Corps zamak/Patère acier. Lampe LED fournie.

**Version 01 - Sur patère**

500 lm



6W ◀ 36° GU10 15 000 h

| Lumens | Teinte | Couleur | Code | € HT   |
|--------|--------|---------|------|--------|
| 500    | 3000 K | blanc   | 1125 | 82,60  |
| 500    | 3000 K | doré    | 1126 | 101,00 |

**Version B2 - Sur patère barre 2 spots**

1000 lm

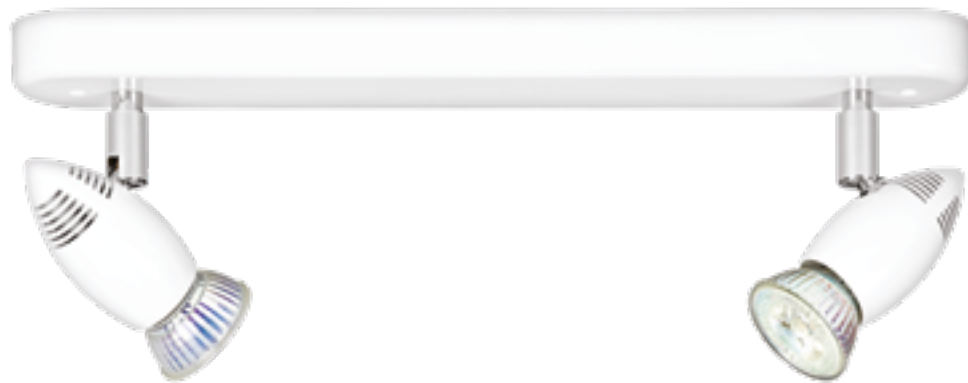

2x 6W ◀ 36° GU10 15 000 h

| Lumens | Teinte | Couleur | Code | € HT   |
|--------|--------|---------|------|--------|
| 2x 500 | 3000 K | blanc   | 0785 | 134,60 |

**Version B3 - Sur patère barre 3 spots**

1500 lm



3x 6W ◀ 36° GU10 15 000 h

| Lumens | Teinte | Couleur | Code | € HT   |
|--------|--------|---------|------|--------|
| 3x 500 | 3000 K | blanc   | 0786 | 197,90 |

## PYXIS rail - LED 6



500 lm

Corps zamak. Lampe LED fournie.

## Version 029 - Pour rail 1 allumage (p. 125)

6W  $\triangleleft$  36° GU10 15 000 h

| Lumens | Teinte | Couleur | Code | € HT  |
|--------|--------|---------|------|-------|
| 500    | 3000 K | blanc   | 1289 | 90,80 |

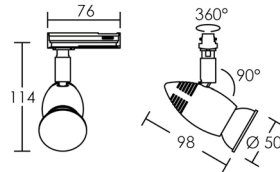

## Version 023 - Pour rail 3 allumages (p. 124)

6W  $\triangleleft$  36° GU10 15 000 h

| Lumens | Teinte | Couleur | Code | € HT  |
|--------|--------|---------|------|-------|
| 500    | 3000 K | blanc   | 0784 | 88,70 |

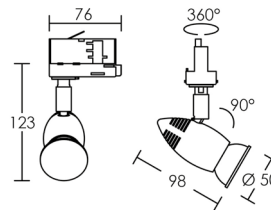

## Version 123 - Pour rail 3 allumages (p. 124)

6W  $\triangleleft$  36° GU10 15 000 h

| Lumens | Teinte | Couleur | Code | € HT   |
|--------|--------|---------|------|--------|
| 500    | 3000 K | blanc   | 0774 | 105,10 |

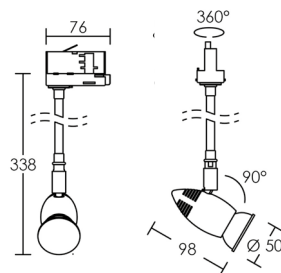

ECCO patère



Corps et patère acier blanc.

Version 01 - Sur patère

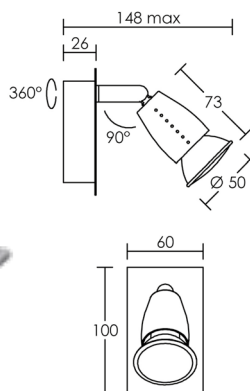

| P (w) | Douille | Couleur | Code sans lampe | € HT         |
|-------|---------|---------|-----------------|--------------|
| 50    | GU10    | blanc   | <b>4662</b>     | <b>18,80</b> |

Version P3 - Plafonnier 3 spots

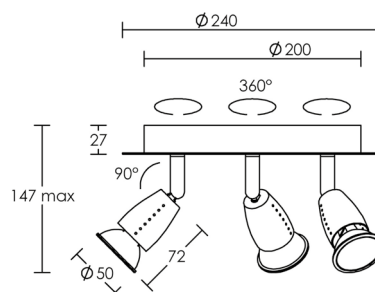
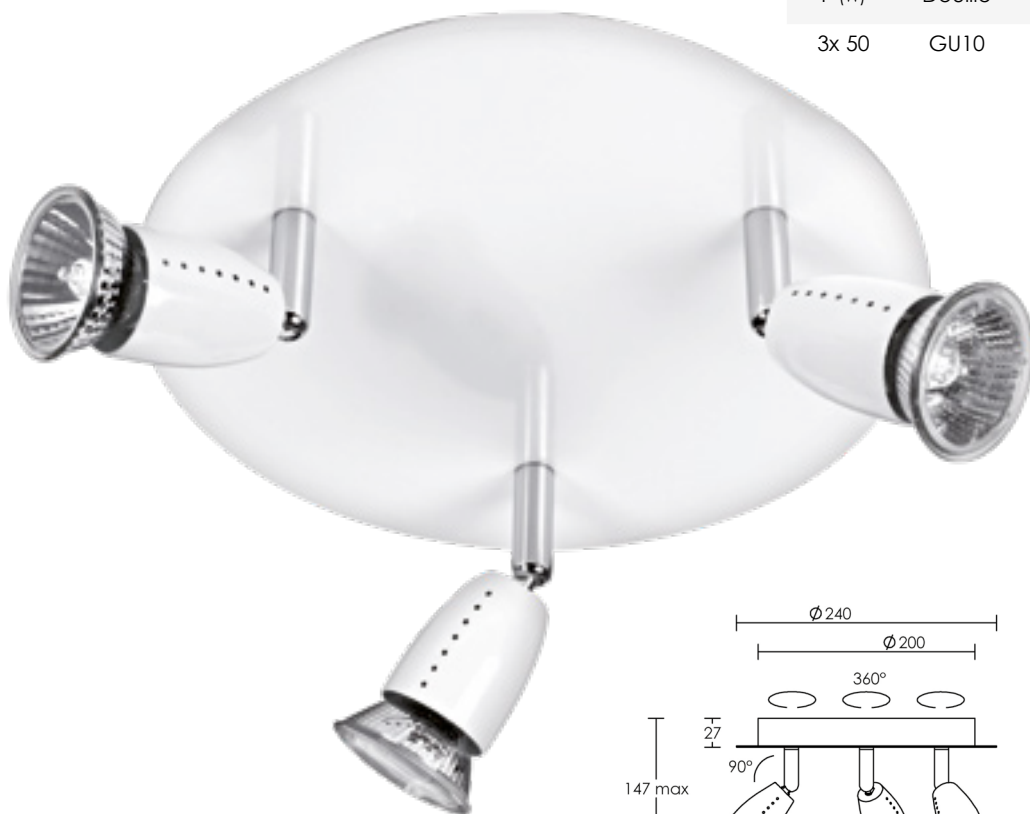

| P (w) | Douille | Couleur | Code sans lampe | € HT         |
|-------|---------|---------|-----------------|--------------|
| 3x 50 | GU10    | blanc   | <b>4665</b>     | <b>60,10</b> |



## ECCO barre



Corps et barre acier blanc.

## Version B2 - Sur barre 2 spots

| P (w) | Douille | Couleur | Code sans lampe | € HT         |
|-------|---------|---------|-----------------|--------------|
| 2x 50 | GU10    | blanc   | <b>4663</b>     | <b>40,10</b> |

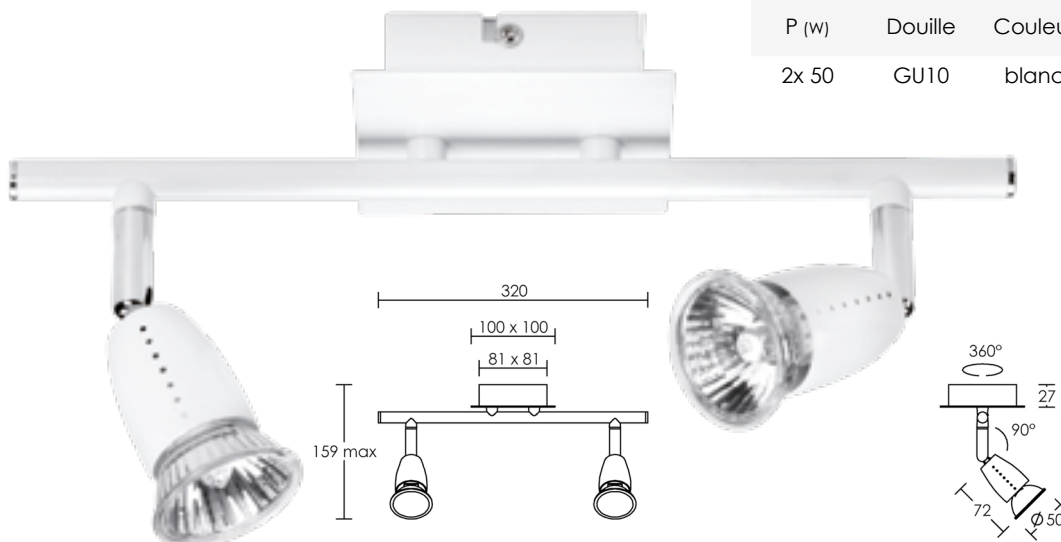

## Version B3 - Sur barre 3 spots

| P (w) | Douille | Couleur | Code sans lampe | € HT         |
|-------|---------|---------|-----------------|--------------|
| 3x 50 | GU10    | blanc   | <b>4664</b>     | <b>60,10</b> |

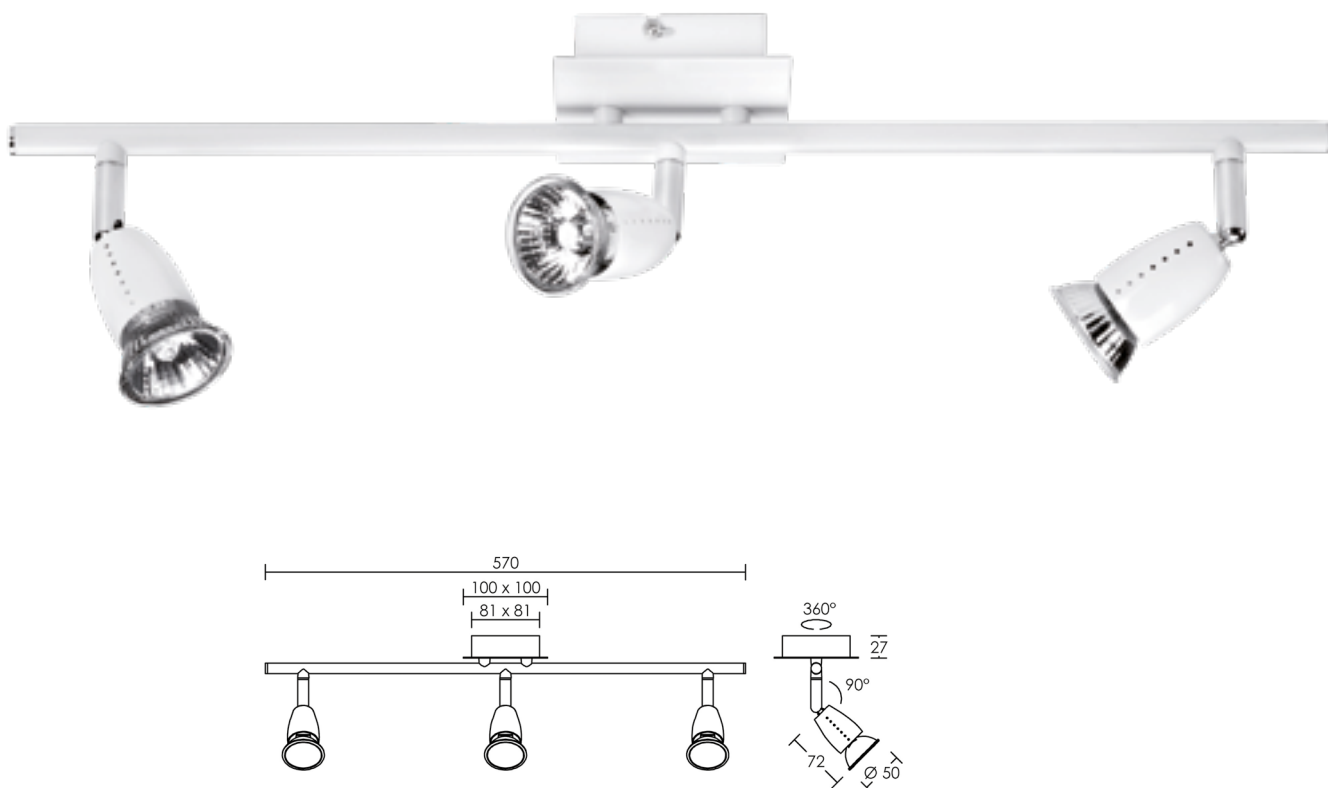

MANTA 63



Corps et patère acier.

Version 01 - Patère

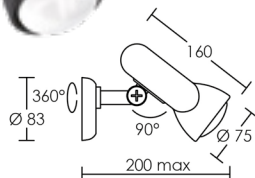

| P (w) | Douille | Couleur | Code sans lampe | € HT  |
|-------|---------|---------|-----------------|-------|
| 60    | E27     | blanc   | 0670            | 29,10 |
| 60    | E27     | noir    | 0669            | 29,10 |

Version 06 - Pince

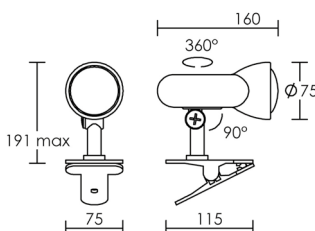

| P (w) | Douille | Couleur | Code sans lampe | € HT  |
|-------|---------|---------|-----------------|-------|
| 60    | E27     | blanc   | 0673*           | 35,30 |

\*Fil 1,40 m, fiche 6A et interrupteur.

Version B2 - Sur patère barre 2 spots

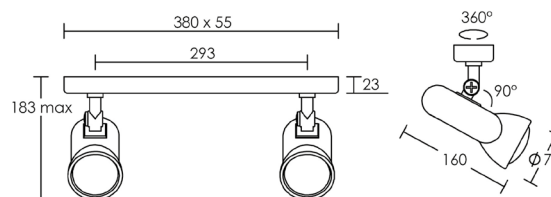
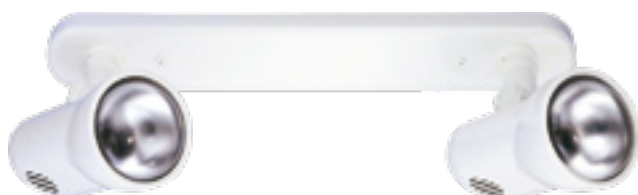

| P (w) | Douille | Couleur | Code sans lampe | € HT  |
|-------|---------|---------|-----------------|-------|
| 2x 60 | E27     | blanc   | 0676            | 62,60 |

Version P3 - Plafonnier 3 spots

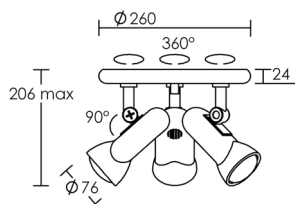

| P (w) | Douille | Couleur | Code sans lampe | € HT  |
|-------|---------|---------|-----------------|-------|
| 3x 60 | E27     | blanc   | 0679            | 84,80 |



REMORA



Corps et patère acier.

Version 01 - Patère sans inter.

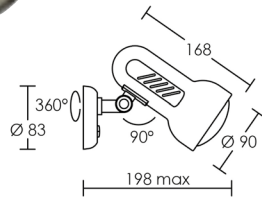

| P (w) | Douille | Couleur  | Code sans lampe | € HT         |
|-------|---------|----------|-----------------|--------------|
| 100   | E27     | blanc    | <b>0600</b>     | <b>26,50</b> |
| 100   | E27     | graphite | <b>0601</b>     | <b>26,50</b> |

Version 01 - Patère avec inter.

| P (w) | Douille | Couleur | Code sans lampe | € HT         |
|-------|---------|---------|-----------------|--------------|
| 100   | E27     | blanc   | <b>0688</b>     | <b>31,70</b> |

Version 06 - Pince

| P (w) | Douille | Couleur  | Code sans lampe | € HT         |
|-------|---------|----------|-----------------|--------------|
| 100   | E27     | blanc    | <b>0691*</b>    | <b>40,00</b> |
| 100   | E27     | graphite | <b>0692*</b>    | <b>40,00</b> |

\*Fil 1,70 m, fiche 6A et interrupteur.

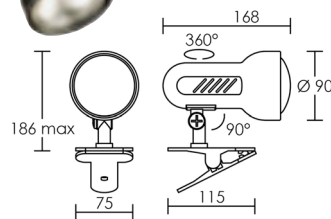

Version B2 - Sur patère barre 2 spots

| P (w)  | Douille | Couleur | Code sans lampe | € HT         |
|--------|---------|---------|-----------------|--------------|
| 2x 100 | E27     | blanc   | <b>0694</b>     | <b>69,70</b> |

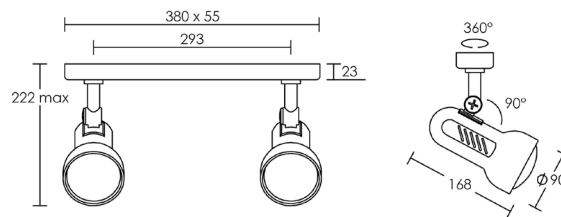

Version P3 - Plafonnier 3 spots

| P (w)  | Douille | Couleur | Code sans lampe | € HT          |
|--------|---------|---------|-----------------|---------------|
| 3x 100 | E27     | blanc   | <b>0696</b>     | <b>100,30</b> |

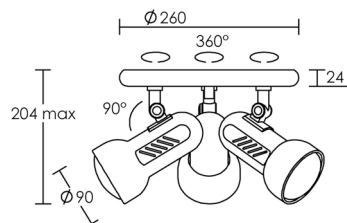

**TURBO**



Corps acier blanc.

**Version 01 - Patère**



Patère blanche.

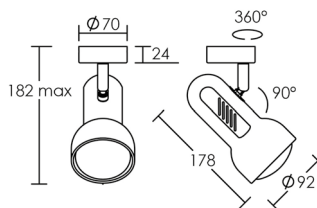

| P (w) | Douille | Couleur | Code sans lampe | € HT         |
|-------|---------|---------|-----------------|--------------|
| 100   | E27     | blanc   | <b>0617</b>     | <b>28,70</b> |

**Version 029 - Pour rail 1 allumage (p. 125)**

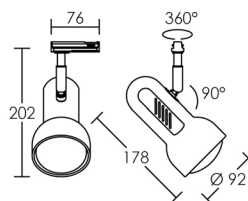

| P (w) | Douille | Couleur | Code sans lampe | € HT         |
|-------|---------|---------|-----------------|--------------|
| 100   | E27     | blanc   | <b>1290</b>     | <b>44,40</b> |

**Lampes adaptées à ces appareils (p. 26) :**

**R80 - RÉFLECTEUR LED**



900 lm



| P (w) | Culot | Lumens | Teinte   | Code        | € HT         |
|-------|-------|--------|----------|-------------|--------------|
| 8     | E27   | 730    | ● 2700 K | <b>2988</b> | <b>17,30</b> |
| 10    | E27   | 900    | ● 2700 K | <b>2963</b> | <b>22,40</b> |

CASA

Patère



Patère bois/Réflecteur aluminium.

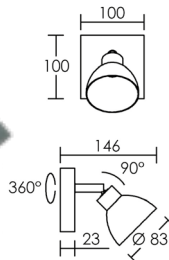

| P (w) | Douille | Couleur    | Code sans lampe | € HT  |
|-------|---------|------------|-----------------|-------|
| 60    | GU10    | bois ébène | 0378            | 30,70 |

RYBA

Patère



Patère et corps acier.

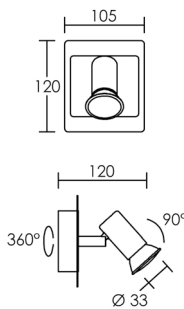

| P (w) | Douille | Couleur      | Code sans lampe | € HT  |
|-------|---------|--------------|-----------------|-------|
| 50    | GU10    | acier brossé | 4671            | 31,40 |

Lampes adaptées à ces appareils (p. 19) :

GU10 - GLASS LED



500 lm

Dimensions et rendu lumineux comparables à la version halogène.

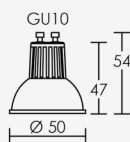

| P (w) | Faisceau | Lumens | Teinte   | Code | € HT |
|-------|----------|--------|----------|------|------|
| 6     | 36°      | 500    | ● 3000 K | 2890 | 6,90 |
| 6     | 36°      | 500    | ○ 4000 K | 2897 | 6,90 |

| GLASS | 3000K                 | 6W    | 36° |
|-------|-----------------------|-------|-----|
| h (m) | E <sub>max</sub> (lx) | d (m) |     |
| 1     | 888                   | 0,65  |     |
| 2     | 222                   | 1,3   |     |
| 3     | 99                    | 1,9   |     |

| GLASS | 4000K                 | 6W    | 36° |
|-------|-----------------------|-------|-----|
| h (m) | E <sub>max</sub> (lx) | d (m) |     |
| 1     | 888                   | 0,65  |     |
| 2     | 222                   | 1,3   |     |
| 3     | 99                    | 1,9   |     |



## RÉGLETTE SALLE D'EAU

MAUD ASYMÉTRIQUE .....p. 166



MAUD SYMÉTRIQUE .....p. 167



IDYL .....p. 169



KATE .....p. 169



POP .....p. 170



ONDE .....p. 171



ONDINE .....p. 172



H2O .....p. 173



TALASSO .....p. 174



NORMARIC B85 .....p. 176



NORMARIC B52 .....p. 178



## RÉGLETTE IP20

MF .....p. 175



TORI .....p. 180



DESIGN .....p. 181



HALOLITE LED .....p. 182



HALOLED .....p. 182



CERES LED / T5 .....p. 183



SERENA .....p. 184



## RÉGLETTE MEUBLE

LORA LED .....p. 185



BART .....p. 186



SENSO LED .....p. 187



MODULED 24 .....p. 188



SLIMLED .....p. 190



CABLED .....p. 191



LUMIRAI .....p. 191



# MAUD ASYMÉTRIQUE



Corps et diffuseur polycarbonate/Diffuseur opale.Pose horizontale ou verticale.

## Version blanche

800 lm



**Autorisé volume 2** sauf le modèle avec inter. + prise. IP44 en pose verticale pour la version simple, et la version avec interrupteur (**orienté vers le bas**).

| Version       | Classe | IP    | Teinte   | Durée de vie | P (W) | L (mm) | Lumens | Code         | € HT         |
|---------------|--------|-------|----------|--------------|-------|--------|--------|--------------|--------------|
| simple        |        | 44    | ● 2700 K | 20 000 h     | 6     | 432    | 600    | <b>53041</b> | <b>46,90</b> |
| inter.        |        | 44    | ● 2700 K | 20 000 h     | 6     | 434    | 600    | <b>53042</b> | <b>51,00</b> |
| prise + inter |        | 20/21 | ● 2700 K | 20 000 h     | 6     | 436    | 600    | <b>53043</b> | <b>58,10</b> |
| simple        |        | 44    | ○ 4000 K | 35 000 h     | 8     | 432    | 800    | <b>53024</b> | <b>52,00</b> |
| inter.        |        | 44    | ○ 4000 K | 35 000 h     | 8     | 434    | 800    | <b>53025</b> | <b>56,10</b> |
| prise + inter |        | 20/21 | ○ 4000 K | 35 000 h     | 8     | 436    | 800    | <b>53026</b> | <b>63,20</b> |

## Version grise

800 lm

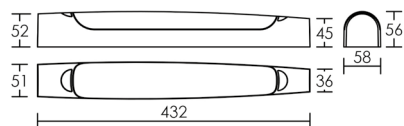

| Version | Classe | IP | Teinte   | Durée de vie | P (W) | L (mm) | Lumens | Code         | € HT         |
|---------|--------|----|----------|--------------|-------|--------|--------|--------------|--------------|
| simple  |        | 44 | ● 2700 K | 20 000 h     | 6     | 432    | 600    | <b>53060</b> | <b>61,20</b> |
| simple  |        | 44 | ○ 4000 K | 35 000 h     | 8     | 432    | 800    | <b>53061</b> | <b>66,30</b> |

MAUD SYMÉTRIQUE



Corps et diffuseur polycarbonate/Diffuseur opale. Pose horizontale ou verticale.

Version blanche

700 lm

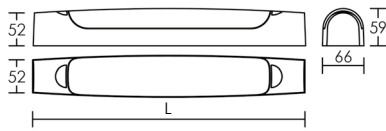

Autorisé volume 2 sauf le modèle avec inter. + prise. IP44 en pose verticale pour la version simple, uniquement.

| Version       | Classe | IP    | Teinte   | Durée de vie | P (W) | L (mm) | Lumens | Code         | € HT         |
|---------------|--------|-------|----------|--------------|-------|--------|--------|--------------|--------------|
| simple        | □      | 44    | ● 2700 K | 20 000 h     | 6     | 432    | 600    | <b>53044</b> | <b>41,80</b> |
| inter.        | □      | 44    | ● 2700 K | 20 000 h     | 6     | 434    | 600    | <b>53045</b> | <b>45,90</b> |
| prise + inter | ⊕      | 20/21 | ● 2700 K | 20 000 h     | 6     | 436    | 600    | <b>53046</b> | <b>54,10</b> |
| simple        | □      | 44    | ○ 4000 K | 20 000 h     | 6     | 432    | 700    | <b>53057</b> | <b>41,80</b> |
| inter.        | □      | 44    | ○ 4000 K | 20 000 h     | 6     | 434    | 700    | <b>53058</b> | <b>45,90</b> |
| prise + inter | ⊕      | 20/21 | ○ 4000 K | 20 000 h     | 6     | 436    | 700    | <b>53059</b> | <b>54,10</b> |

Version grise

700 lm

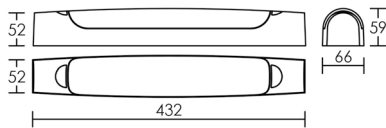

| Version | Classe | IP | Teinte   | Durée de vie | P (W) | L (mm) | Lumens | Code         | € HT         |
|---------|--------|----|----------|--------------|-------|--------|--------|--------------|--------------|
| simple  | □      | 44 | ● 2700 K | 20 000 h     | 6     | 432    | 600    | <b>53062</b> | <b>56,10</b> |
| simple  | □      | 44 | ○ 4000 K | 20 000 h     | 6     | 432    | 700    | <b>53071</b> | <b>56,10</b> |

# VOLUMES DES SALLES D'EAU

Pour toute installation dans une salle d'eau, se conformer impérativement à la norme NFC 15-100 partie 7-701.

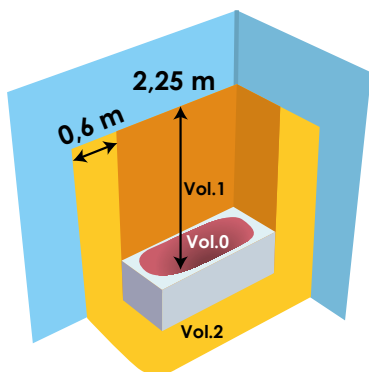

**Cas d'une salle d'eau avec baignoire**  
2,25 m mini au fond de la baignoire.

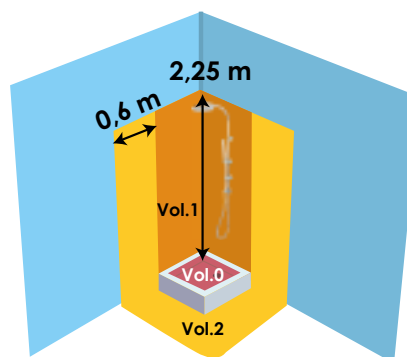

**Cas d'une salle d'eau avec receveur ou bac**  
2,25 m mini au fond du receveur.

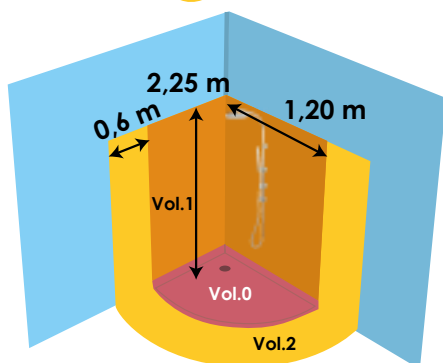

**Cas d'une douche à l'italienne**  
2,25 m mini du sol fini.

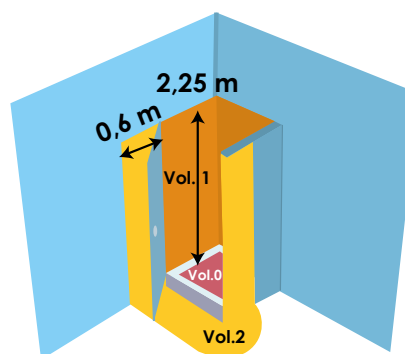

**Cas d'une douche avec paroi ou cloison et porte**  
2,25 m mini du fond du receveur ou sol fini.

## VOLUME 0

C'est le volume intérieur de la baignoire ou du receveur de douche. Pour les douches de plain-pied à l'italienne (sans receveur), il est délimité par le fond de la douche et le plan horizontal situé 10 cm au dessus du point le plus haut du fond de la douche et en partie latérale par les limites du volume 1.

**Sont autorisés les luminaires IPX7 de classe 3 alimentés en TBTS limitée à 12V en courant alternatif 30V en courant continu alimentés en T.B.TS.**

L'alimentation de sécurité doit être installée en dehors des volumes 0, 1 et 2.

## VOLUME 1

C'est le volume délimité en partie latérale :

- par les bords extérieurs de la baignoire ou du receveur de douche,
- pour les douches de plain-pied à l'italienne (sans receveur), par le cylindre vertical de rayon 1,20 m et dont l'axe passe par le centre de la tête de douche, par le point-raccord du flexible de douchette ou par l'ensemble des points constituant le périmètre extérieur de la douche pluie,
- pour les douches à jet horizontaux, les parois faisant obstacle aux jets.

Sa hauteur est limitée par le plus élevé des plans horizontaux suivants, soit au-dessus du volume 0 jusqu'à 2,25 m au dessus du sol fini ou du fond de la baignoire si celui-ci est au dessus du sol fini, soit au-dessus de la douche de tête.

Dans le cas de douche à têtes multiples, le volume 1 est délimité par l'ensemble des volumes individuels définis depuis chaque tête ou flexible

**Sont autorisés les luminaires de classe 3 alimentés en TBTS limitée à 12V courant alternatif ou 30V courant continu - IP X4 ou, IP X5 en présence de jets horizontaux en provenance d'une douche ou pour raison de nettoyage.**

L'alimentation doit être installée en dehors des volumes 0, 1 et 2.

## VOLUME 2

C'est le volume situé à 0,6 m du bord du volume 1. La limite en hauteur est identique à celle du volume 1. La limite basse est celle du sol fini.

**Sont autorisés les luminaires de classe 2 - 230V et protégés par disjoncteur différentiel résiduel de 30 mA max - IP X4 ou, IP X5 en présence de jets horizontaux pour raison de nettoyage, et les luminaires autorisés en volume 1.**

L'alimentation doit être installée en dehors des volumes 0, 1 et 2.

## HORS VOLUMES

C'est le volume situé en dehors des volumes 0, 1, et 2.



IDYL



700 lm



Corps et diffuseur polycarbonate/Diffuseur opale.  
Pose horizontale ou verticale (interrupteur vers le bas).  
Circuit LED SMD. **Alimentation intégrée.**  
Variation de l'intensité lumineuse sur 3 niveaux gérée par interrupteur : 100% / 50% / 10%.

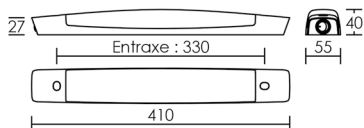

| Version     | P (w) | Lumens | Teinte   | Code         | € HT         | 30 000 h |
|-------------|-------|--------|----------|--------------|--------------|----------|
| sans inter. | 6     | 600    | ● 2700 K | <b>53072</b> | <b>39,80</b> |          |
| sans inter. | 6     | 700    | ○ 4000 K | <b>53073</b> | <b>39,80</b> |          |
| avec inter. | 6     | 600    | ● 2700 K | <b>53074</b> | <b>43,90</b> |          |
| avec inter. | 6     | 700    | ○ 4000 K | <b>53075</b> | <b>43,90</b> |          |

Dimmable par interrupteur : ne pas utiliser sur variateur.

KATE



800 lm



Corps aluminium anodisé/Diffuseur polycarbonate opale.

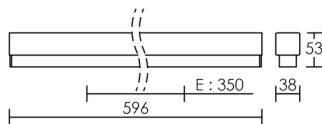
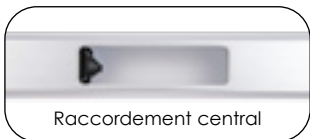

| P (w) | Lumens | Teinte   | Code         | € HT         | 30 000 h |
|-------|--------|----------|--------------|--------------|----------|
| 7     | 800    | ○ 4000 K | <b>53051</b> | <b>87,70</b> |          |



Corps aluminium anodisé/Diffuseur polycarbonate opale.



### Avec circuit LED intégré



1200 lm

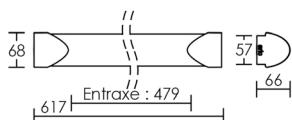

Circuit LED SMD. Alimentation intégrée.

| Version     | P (w) | Lumens | Teinte   | Code         | 35 000 h      |
|-------------|-------|--------|----------|--------------|---------------|
|             |       |        |          |              | € HT          |
| sans inter. | 19    | 1150   | ● 3000 K | <b>53012</b> | <b>147,90</b> |
| sans inter. | 19    | 1200   | ○ 4000 K | <b>53010</b> | <b>147,90</b> |
| avec inter. | 19    | 1150   | ● 3000 K | <b>53013</b> | <b>155,00</b> |
| avec inter. | 19    | 1200   | ○ 4000 K | <b>53011</b> | <b>155,00</b> |

### Sans/avec tube T5 fluorescent

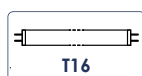

Raccordement électrique central, sauf version 39W.  
Ballast électronique A2 intégré. Utilisation salle de bain (Vol. 2), **sauf version 39W (uniquement Hors Vol.)**.

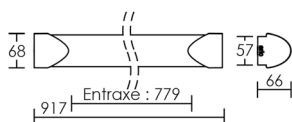
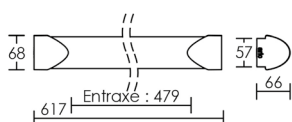

| Version                  | Classe | G5 Ø16 |        | Code | 24 000 h                  |
|--------------------------|--------|--------|--------|------|---------------------------|
|                          |        | P (w)  | L (mm) |      | Douille                   |
| <b>AVEC INTERRUPTEUR</b> |        |        |        |      |                           |
| avec tube HE<br>● 3000 K | □      | 14     | 617    | G5   | <b>5216</b> <b>96,00</b>  |
| avec tube HE<br>○ 4000 K | □      | 14     | 617    | G5   | <b>5219</b> <b>96,00</b>  |
| sans tube                | □      | 21     | 917    | G5   | <b>4787</b> <b>108,10</b> |
| sans tube                | ⊕      | 39     | 917    | G5   | <b>4788</b> <b>145,70</b> |
| <b>SANS INTERRUPTEUR</b> |        |        |        |      |                           |
| sans tube                | □      | 14     | 617    | G5   | <b>4789</b> <b>91,60</b>  |
| sans tube                | □      | 24     | 617    | G5   | <b>4790</b> <b>104,80</b> |
| sans tube                | □      | 21     | 917    | G5   | <b>4791</b> <b>103,70</b> |
| sans tube                | ⊕      | 39     | 917    | G5   | <b>4792</b> <b>141,20</b> |

L'utilisation sur minuterie diminue considérablement la durée de vie des lampes.

ONDE



Corps aluminium anodisé/Diffuseur polycarbonate opale. Raccordement électrique central.

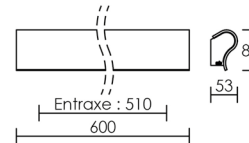

Avec circuit LED intégré



950 lm



35 000 h

| P (w) | Lumens | Teinte   | Code         | € HT          |
|-------|--------|----------|--------------|---------------|
| 13    | 880    | ● 3000 K | <b>53080</b> | <b>129,50</b> |
| 13    | 950    | ○ 4000 K | <b>53030</b> | <b>129,50</b> |

Avec tube T5 fluorescent

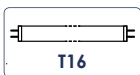

Ballast électronique A2 intégré. Avec tube T5 fluo HE 100 lm/W.

Ø16 24 000 h

| P (w) | Douille | Teinte   | Code        | € HT          |
|-------|---------|----------|-------------|---------------|
| 14    | G5      | ● 3000 K | <b>5212</b> | <b>103,70</b> |
| 14    | G5      | ○ 4000 K | <b>5214</b> | <b>103,70</b> |

L'utilisation sur minuterie diminue considérablement la durée de vie des lampes.

ONDINE



Corps aluminium laqué blanc/Vasque polycarbonate striée (LOR = 72%)/Réflecteur aluminium. Pose murale ou verticale. Interrupteur orienté vers le bas.

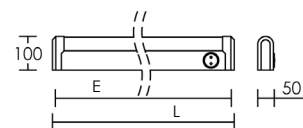

Avec tube T8 LED

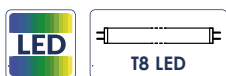

1235 lm

| Version    | L (mm) | Entraxe (mm) | P (w) | Lumens | Teinte  | Code        | € HT          | 30 000 h |
|------------|--------|--------------|-------|--------|---------|-------------|---------------|----------|
| sans inter | 638    | 621          | 9     | 650    | ○4000 K | <b>5425</b> | <b>91,80</b>  |          |
| avec inter | 638    | 621          | 9     | 650    | ○4000 K | <b>5426</b> | <b>93,80</b>  |          |
| sans inter | 1248   | 1231         | 17    | 1235   | ○4000 K | <b>5424</b> | <b>147,90</b> |          |
| avec inter | 1248   | 1231         | 17    | 1235   | ○4000 K | <b>5427</b> | <b>149,90</b> |          |

Tube T8 9W 4000 K de rechange (code **2873**).  
Tube T8 17W 4000 K de rechange (code **2874**).

Sans tube



Ballast électronique.

G13 Ø26

| Version    | P (w) | L (mm) | Entraxe (mm) | Code        | € HT          |
|------------|-------|--------|--------------|-------------|---------------|
| sans inter | 18    | 638    | 621          | <b>0312</b> | <b>79,60</b>  |
| avec inter | 18    | 638    | 621          | <b>0313</b> | <b>82,60</b>  |
| sans inter | 36    | 1248   | 1231         | <b>5411</b> | <b>134,60</b> |

Interrupteur de remplacement (**nous consulter**).

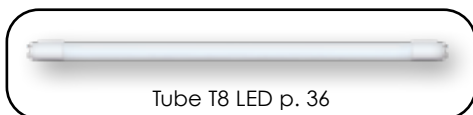

Tube T8 LED p. 36

H2O



Corps et diffuseur polycarbonate blanc/Diffuseur opale strié (LOR = 47%). Raccordement électrique central.  
Montage en applique murale et en angle.



Avec tube T5 LED

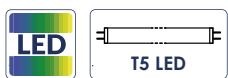

495 lm



Interrupteur

50 000 h

| Version    | P (W) | Lumens | Teinte  | Code         | € HT          |
|------------|-------|--------|---------|--------------|---------------|
| sans inter | 7     | 495    | ○4000 K | <b>53076</b> | <b>107,10</b> |
| avec inter | 7     | 495    | ○4000 K | <b>53077</b> | <b>111,20</b> |

Sans tube

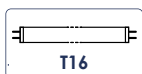

Ballast électronique.

Ø16

| Version    | P (W) | L (mm) | Douille | Code        | € HT         |
|------------|-------|--------|---------|-------------|--------------|
| sans inter | 14    | 611    | G5      | <b>2401</b> | <b>79,50</b> |
| avec inter | 14    | 611    | G5      | <b>2402</b> | <b>81,50</b> |

L'utilisation sur minuterie diminue considérablement la durée de vie des lampes.

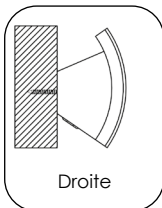

Droite

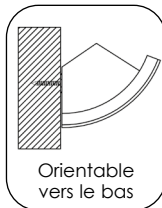

Orientable vers le bas

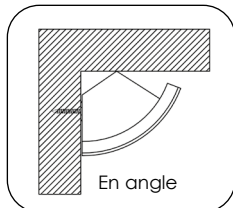

En angle

Lampe adaptée à ces appareils (p. 36) :

TUBE T5 LED



1050 lm

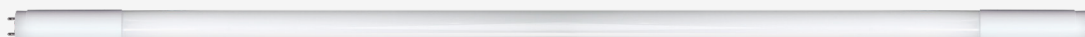

Lampe tube T5 opale. Culot G5, Ø16 mm. Convient pour fonctionnement sur ballast électronique\* en remplacement des T5 fluo.

| P (W) | L (mm) | Lumens | Teinte  | Code        | € HT         |
|-------|--------|--------|---------|-------------|--------------|
| 7     | 549    | 1050   | ○4000 K | <b>2876</b> | <b>44,40</b> |

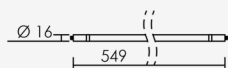

\* Nous ne pouvons garantir la compatibilité avec tous les ballasts du marché. Merci de vous référer aux préconisations d'utilisation ci-contre.

TALASSO



Corps polyamide chargé fibre de verre blanc/Diffuseur polycarbonate opale. Applique murale. Installation horizontale.  
Utilisation salle de bain (Vol. 2), **sauf version Prise 16A + inter (uniquement Hors Vol.)**.  
Transformateur de séparation de circuit 230V/20VA intégré pour prise rasoir 2P.

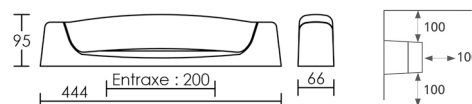

Avec tube LED 7W



525 lm

|                      |           | 7W Ø38 x 310 mm |        |          | 20 000 h |              |              |
|----------------------|-----------|-----------------|--------|----------|----------|--------------|--------------|
| Version              | Référence | Classe          | Lumens | Teinte   | IP       | Code         | € HT         |
| simple               | B 99.00   |                 | 450    | ● 2700 K | 24       | <b>53037</b> | <b>38,40</b> |
| inter. protégé       | B 99.01   |                 | 450    | ● 2700 K | 24       | <b>53038</b> | <b>40,10</b> |
| prise 16A + inter    | B 99.17   |                 | 450    | ● 2700 K | 21       | <b>53039</b> | <b>45,80</b> |
| prise rasoir + inter | B 99.21   |                 | 450    | ● 2700 K | 24       | <b>53040</b> | <b>67,00</b> |
| simple               | B 99.00   |                 | 525    | ○ 4000 K | 24       | <b>53067</b> | <b>38,40</b> |
| inter. protégé       | B 99.01   |                 | 525    | ○ 4000 K | 24       | <b>53068</b> | <b>40,10</b> |
| prise 16A + inter    | B 99.17   |                 | 525    | ○ 4000 K | 21       | <b>53069</b> | <b>45,80</b> |
| prise rasoir + inter | B 99.21   |                 | 525    | ○ 4000 K | 24       | <b>53070</b> | <b>67,00</b> |

Diffuseur de rechange (code **1226**).  
Interrupteur de remplacement (**nous consulter**).

Sans tube



|                      |           | Ø38 x 310 mm |       |         |    |             |              |
|----------------------|-----------|--------------|-------|---------|----|-------------|--------------|
| Version              | Référence | Classe       | P (w) | Douille | IP | Code        | € HT         |
| simple               | B 99.00   |              | 60    | S19     | 24 | <b>1120</b> | <b>21,40</b> |
| inter. protégé       | B 99.01   |              | 60    | S19     | 24 | <b>1121</b> | <b>24,30</b> |
| prise 16A + inter    | B 99.17   |              | 60    | S19     | 21 | <b>1122</b> | <b>29,90</b> |
| prise rasoir + inter | B 99.21   |              | 60    | S19     | 24 | <b>1124</b> | <b>51,10</b> |

Diffuseur de rechange (code **1226**).  
Interrupteur de remplacement (**nous consulter**).



## LINOLITE LED (p. 33)



- ✓ 100% équivalente à l'incandescence
- ✓ 4W - 400 lm - 2700 K  
6W - 600 lm - 2700 K  
6W - 700 lm - 4000 K
- ✓ Flux dirigé > 60W incan.

✓ Conçue et fabriquée dans nos ateliers

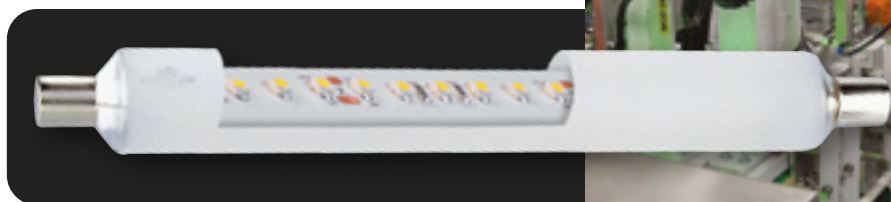

- ✓ Fait l'objet d'un brevet français  
N° 15/52375

**NORMARIC B85-C**



Corps polypropylène blanc/Diffuseur polycarbonate. Applique murale. Installation horizontale.  
Utilisation salle de bain (Vol. 2), **sauf version Prise 16A + inter (uniquement Hors Vol.)**.

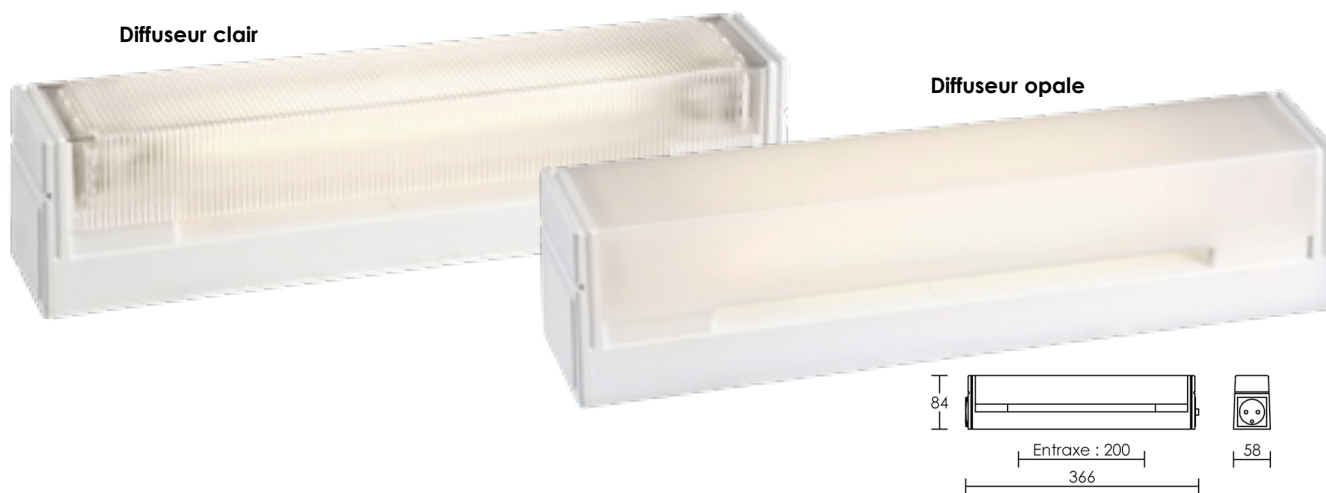

**Clair/Opale - Avec tube LED 7W**



540 lm

|                             |           |        | 7W Ø38 x 310 mm |          |    | 20 000 h     |              |
|-----------------------------|-----------|--------|-----------------|----------|----|--------------|--------------|
| Version                     | Référence | Classe | Lumens          | Teinte   | IP | Code V.Pack  | € HT         |
| <b>avec diffuseur clair</b> |           |        |                 |          |    |              |              |
| simple                      | B 85C.00  | □      | 540             | ● 2700 K | 24 | <b>53020</b> | <b>32,60</b> |
| inter. protégé              | B 85C.01  | □      | 540             | ● 2700 K | 24 | <b>53021</b> | <b>35,00</b> |
| prise 16A + inter           | B 85C.17  | ⊕      | 540             | ● 2700 K | 21 | <b>53022</b> | <b>39,70</b> |
| <b>avec diffuseur opale</b> |           |        |                 |          |    |              |              |
| simple                      | B 85C.00  | □      | 480             | ● 2700 K | 24 | <b>53031</b> | <b>32,60</b> |
| inter. protégé              | B 85C.01  | □      | 480             | ● 2700 K | 24 | <b>53032</b> | <b>35,00</b> |
| prise 16A + inter           | B 85C.17  | ⊕      | 480             | ● 2700 K | 21 | <b>53033</b> | <b>39,70</b> |

**Clair - Sans tube**



|                   |           |        | Ø38 x 310 mm |         |    |             |              |
|-------------------|-----------|--------|--------------|---------|----|-------------|--------------|
| Version           | Référence | Classe | P (w)        | Douille | IP | Code        | € HT         |
| simple            | B 85C.00  | □      | 60           | S19     | 24 | <b>0250</b> | <b>16,70</b> |
| inter. protégé    | B 85C.01  | □      | 60           | S19     | 24 | <b>0251</b> | <b>19,10</b> |
| prise 16A + inter | B 85C.17  | ⊕      | 60           | S19     | 21 | <b>0252</b> | <b>28,90</b> |

Diffuseur de rechange, code **0920**.





**NORMARIC B85-L**



Corps polypropylène blanc/Diffuseur polycarbonate. Applique murale. Installation horizontale.  
Utilisation salle de bain (Vol. 2), **sauf version Prise 16A + inter (uniquement Hors Vol.)**.  
Transformateur de séparation de circuit 230V/20VA intégré pour prise rasoir 2P.

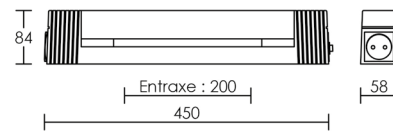

**Opale - Avec tube LED 7W**



480 lm

| Version           | Référence | Classe | 7W Ø38 x 310 mm |        |    | Code  | 20 000 h | € HT |
|-------------------|-----------|--------|-----------------|--------|----|-------|----------|------|
|                   |           |        | Lumens          | Teinte | IP |       |          |      |
| simple            | B 85L.00  |        | 480             | 2700 K | 24 | 53034 | 34,00    |      |
| inter. protégé    | B 85L.01  |        | 480             | 2700 K | 24 | 53035 | 36,40    |      |
| prise 16A + inter | B 85L.17  |        | 480             | 2700 K | 21 | 53036 | 40,90    |      |

**Clair - Sans tube**



| Version              | Référence | Classe | Ø38 x 310 mm |         |    |      | Code  | € HT |
|----------------------|-----------|--------|--------------|---------|----|------|-------|------|
|                      |           |        | P (W)        | Douille | IP |      |       |      |
| prise rasoir + inter | B 85L.21  |        | 60           | S19     | 24 | 0255 | 49,10 |      |



# NORMARIC B52



Corps polypropylène blanc/Diffuseur polycarbonate. Applique murale. Installation horizontale.

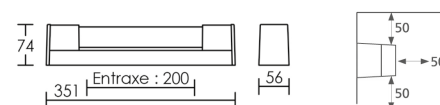

## Avec tube LED 4W



400 lm

| Version           | Référence | Classe |
|-------------------|-----------|--------|
| simple            | B 52.00   |        |
| inter. protégé    | B 52.01   |        |
| prise 16A + inter | B 52.17   |        |

**4W Ø38 x 310 mm 20 000 h**

| Lumens | Teinte | IP | Code          | € HT         |
|--------|--------|----|---------------|--------------|
| 400    | 2700 K | 24 | <b>53027</b>  | <b>24,40</b> |
| 400    | 2700 K | 24 | <b>53028</b>  | <b>26,80</b> |
| 400    | 2700 K | 21 | <b>53029*</b> | <b>31,60</b> |

\* Uniquement HORS-VOLUME.

## Sans tube



| Version           | Référence | Classe |
|-------------------|-----------|--------|
| simple            | B 52.00   |        |
| inter. protégé    | B 52.01   |        |
| prise 16A + inter | B 52.17   |        |

**Ø38 x 310 mm**

| P (W) | Douille | IP | Code         | € HT         |
|-------|---------|----|--------------|--------------|
| 60    | S19     | 24 | <b>0651</b>  | <b>10,80</b> |
| 60    | S19     | 24 | <b>0652</b>  | <b>13,30</b> |
| 60    | S19     | 21 | <b>0653*</b> | <b>18,10</b> |

\* Uniquement HORS-VOLUME.

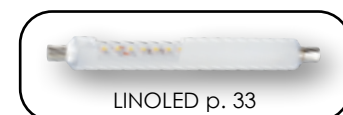

MF



Corps acier blanc. Version simple. Ballast électronique A3.

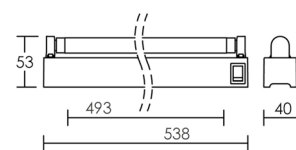

### Avec tube T5 fluorescent

| G5 Ø16 |        |          |             | 6 000 h      |
|--------|--------|----------|-------------|--------------|
| P (w)  | Lumens | Teinte   | Code        | € HT         |
| 13     | 880    | ● 3000 K | <b>0420</b> | <b>42,40</b> |

### Sans tube

| Ø16   |        |         |             |              |
|-------|--------|---------|-------------|--------------|
| P (w) | L (mm) | Douille | Code        | € HT         |
| 13    | 538    | G5      | <b>0418</b> | <b>35,00</b> |



TORI



Corps aluminium/Vasque polycarbonate. Interrupteur. Boîte de connexion centrale située à l'arrière de la réglette.  
Pièce de fixation réglable à l'arrière.

Version 10W

900 lm

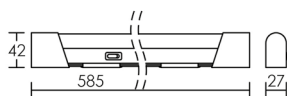

| 10W    |        | 25 000 h  |              |              |
|--------|--------|-----------|--------------|--------------|
| Lumens | Teinte | Couleur   | Code         | € HT         |
| 880    | 3000 K | blanc     | <b>50627</b> | <b>34,70</b> |
| 900    | 4000 K | blanc     | <b>50628</b> | <b>34,70</b> |
| 880    | 3000 K | aluminium | <b>50625</b> | <b>34,70</b> |
| 900    | 4000 K | aluminium | <b>50425</b> | <b>34,70</b> |

Version 5,5W

400 lm

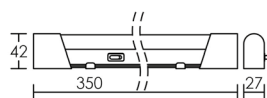

| 5,5W   |        | 25 000 h  |              |              |
|--------|--------|-----------|--------------|--------------|
| Lumens | Teinte | Couleur   | Code         | € HT         |
| 380    | 3000 K | blanc     | <b>50629</b> | <b>25,50</b> |
| 400    | 4000 K | blanc     | <b>50630</b> | <b>25,50</b> |
| 380    | 3000 K | aluminium | <b>50626</b> | <b>25,50</b> |
| 400    | 4000 K | aluminium | <b>50426</b> | <b>25,50</b> |

## DESIGN



Corps acier gris/Vasque polycarbonate.  
Raccordement électrique central. Interrupteur.

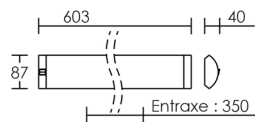

**G5 Ø16** **25 000 h**

| P (W) | Lumens | Teinte   | Code avec tube | € HT         |
|-------|--------|----------|----------------|--------------|
| 13    | 400    | ○ 4000 K | <b>3727</b>    | <b>30,90</b> |

L'utilisation sur minuterie diminue considérablement la durée de vie des lampes.



## HALOLITE LED avec inter



1500 lm

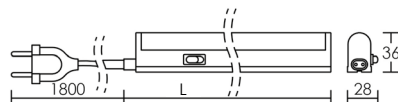
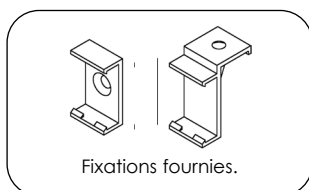
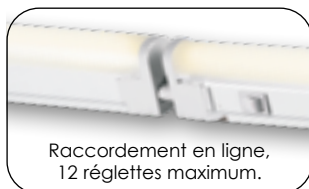

Corps thermoplastique blanc/Diffuseur PMMA. Interrupteur. Ballast électronique. Cordon 1,8 m, fiche 6A. Raccord de 15 cm. Possibilité de raccordement en ligne avec connecteur fourni. Circuit LED SMD. Allumage instantané. Compatible avec les interrupteurs automatiques et les minuteries. Clips de fixation inclus.

| ○ 4000 K |        | 35 000 h |              |              |
|----------|--------|----------|--------------|--------------|
| P (W)    | L (mm) | Lumens   | Code         | € HT         |
| 4        | 286    | 360      | <b>53015</b> | <b>21,40</b> |
| 7        | 514    | 620      | <b>53016</b> | <b>28,60</b> |
| 13       | 847    | 1050     | <b>53017</b> | <b>44,90</b> |
| 18       | 1147   | 1500     | <b>53018</b> | <b>58,10</b> |

## HALOLED avec inter



1100 lm

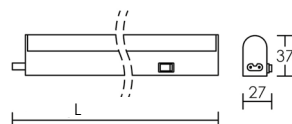

Corps polycarbonate. Interrupteur. Cordon 1,8 m, fiche 6A. Raccord de 15 cm. Possibilité de raccordement en ligne avec connecteur fourni. Clips de fixation inclus.

| ○ 4000 K |        | 25 000 h |              |              |
|----------|--------|----------|--------------|--------------|
| P (W)    | L (mm) | Lumens   | Code         | € HT         |
| 10       | 849    | 1100     | <b>53065</b> | <b>31,60</b> |

CERES 2 LED



450 lm

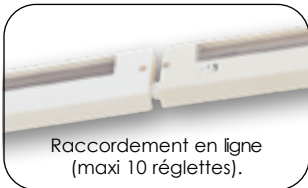

Raccordement en ligne (maxi 10 réglettes).

Corps thermoplastique blanc. Interrupteur. Cordon 1,5 m, fiche 6A. Possibilité de raccordement en ligne avec connecteur fourni.

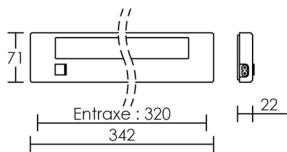

Version 4W

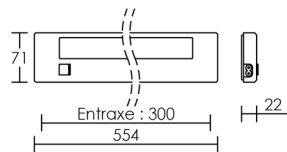

Version 7W

25 000 h

| P (w) | Lumens | Teinte  | Code         | € HT         |
|-------|--------|---------|--------------|--------------|
| 4     | 280    | ○4000 K | <b>53078</b> | <b>35,20</b> |
| 7     | 450    | ○4000 K | <b>53079</b> | <b>46,40</b> |

CERES 2

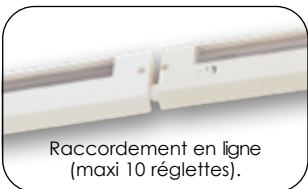

Raccordement en ligne (maxi 10 réglettes).

Corps thermoplastique blanc. Ballast électronique. Interrupteur. Cordon 1,5 m, fiche 6A. Possibilité de raccordement en ligne avec connecteur fourni.

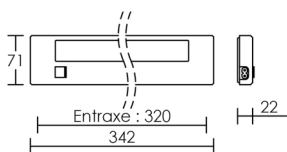

Version 8W

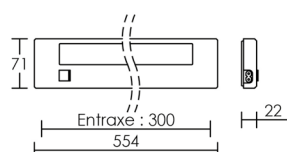

Version 13W

G5 Ø16 6 000 h

| P (w) | Lumens | Teinte  | Code avec tube | € HT         |
|-------|--------|---------|----------------|--------------|
| 8     | 300    | ○4000 K | <b>0401</b>    | <b>28,60</b> |
| 13    | 600    | ○4000 K | <b>0402</b>    | <b>36,70</b> |

SERENA

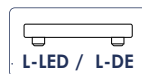

Corps thermoplastique. Applique de sécurité.

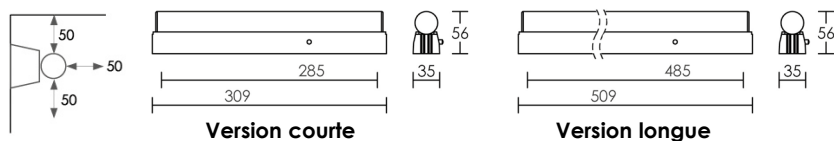

Avec tube LED



640 lm

| S14s  | 2700 K |        |      | 35 000 h |
|-------|--------|--------|------|----------|
| P (w) | L (mm) | Lumens | Code | € HT     |
| 4     | 309    | 320    | 3931 | 54,10    |
| 8     | 509    | 640    | 3932 | 73,40    |

Sans tube

| P (w) | L (mm) | Douille | Code | € HT  |
|-------|--------|---------|------|-------|
| 35    | 309    | S14s    | 0358 | 19,90 |
| 60    | 509    | S14s    | 0362 | 22,50 |





LORA LED



650 lm

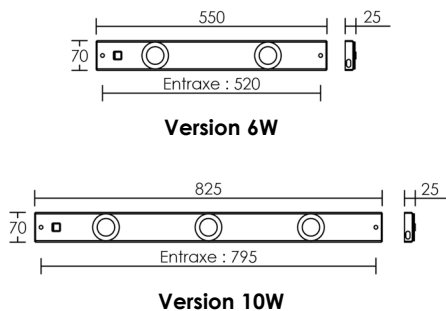

Corps aluminium/Diffuseur polycarbonate opale.  
Alimentation intégrée. Précâblée 2x0.75 mm<sup>2</sup>,  
long. 1,8 m avec fiche 2,5A. Sortie latérale.  
Connexion maxi. 12 pièces en ligne. Interrupteur.

|  |       |        |          |              | 25 000 h     |
|--|-------|--------|----------|--------------|--------------|
|  | P (W) | Lumens | Teinte   | Code         | € HT         |
|  | 6     | 440    | ● 3000 K | <b>50817</b> | <b>45,00</b> |
|  | 10    | 650    | ● 3000 K | <b>50818</b> | <b>52,00</b> |



LAMPE

DOWNLIGHT  
ENCASTRE

RAIL  
PROJECTEUR  
SPOTIERIE

RÉGLETTÉ

## BART



520 lm



Corps aluminium gris/Diffuseur polycarbonate blanc opale. **Alimentation intégrée.** Précâblage 1,5 m + fiche 2P 6A. Sortie latérale. Montage individuel.

25 000 h

| P (w) | Lumens | Teinte | Code | € HT   |
|-------|--------|--------|------|--------|
| 7,5   | 520    | 5000 K | 5127 | 137,70 |

Dimmer sensible intégré. Fonction mémoire.

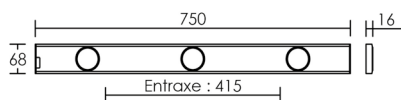

SENSO LED



Corps polycarbonate/Diffuseur opale. Extra plat (7 mm). Fixe.

Kit 2 appliques

600 lm



Kit prêt à poser : 2 spots (1 Maître / 1 Esclave) précâblés 1,5 m avec connecteur. **Alimentation 24V, classe 2, IP20, 15W, précâblée 1,5 m avec connecteur et fiche 2P 6A.**

◀ 100° 35 000 h

| P (W)  | Lumens | Teinte   | Code         | € HT         |
|--------|--------|----------|--------------|--------------|
| 2x 3,5 | 2x 300 | ☉ 3000 K | <b>50623</b> | <b>80,60</b> |

Dimmer sensitif intégré. Fonction mémoire.



Applique seule

300 lm



Spot seul esclave (en complément du kit SENSO LED). Spot dimmable uniquement si raccordé au kit **50623**. Livré avec câble de jonction 1 Maître / 2 Esclaves (code **50683**). Précâblage 1,5 m avec connecteur.

◀ 100° 35 000 h

| P (W) | Lumens | Teinte   | Code         | € HT         |
|-------|--------|----------|--------------|--------------|
| 3,5   | 300    | ☉ 3000 K | <b>50624</b> | <b>30,60</b> |

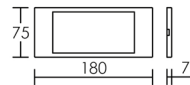
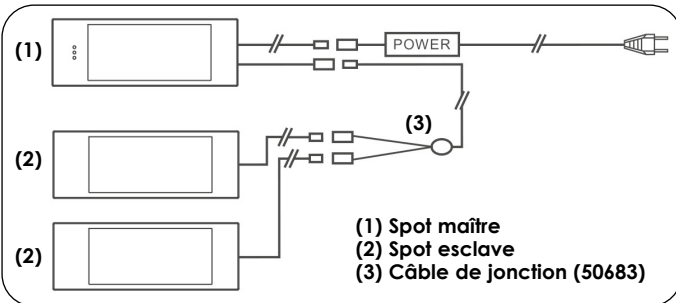

| SENSO | 3000K                 | 3,5 W | 100° |
|-------|-----------------------|-------|------|
| h (m) | E <sub>max</sub> (lx) | d (m) |      |
| 1     | 116                   | 2,38  |      |
| 2     | 29                    | 4,8   |      |
| 3     | 13                    | 7,2   |      |

ACCESSOIRES SENSO LED

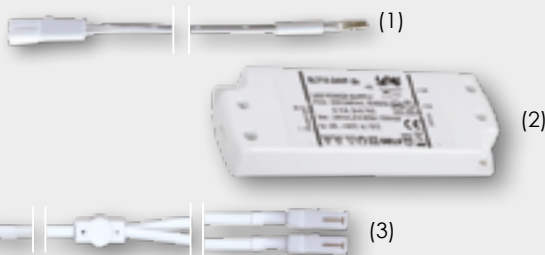

| Désignation   | Code         | € HT         |
|---|--------------|--------------|
| (1) Câble d'alimentation                                    | <b>50684</b> | <b>1,20</b>  |
| (2) Alimentation 15W 24V sans connexion                     | <b>52007</b> | <b>26,50</b> |
| (3) Câble de jonction 1 Maître / 2 Esclaves. Longueur 15 cm | <b>50683</b> | <b>2,50</b>  |

MODULED 24 longueur standard



415 lm



Tube polycarbonate dépoli Ø10 mm, LED SMD type 3528 (IRC > 90), profilé rigide rond. **Éléments standards** avec 2 connexions. Sans clips.

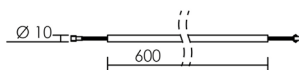

| 30 000 h |        |          |              |              |
|----------|--------|----------|--------------|--------------|
| P (w)    | Lumens | Teinte   | Code         | € HT         |
| 5,7      | 390    | ● 3000 K | <b>55408</b> | <b>59,20</b> |
| 5,7      | 415    | ○ 4200 K | <b>55409</b> | <b>59,20</b> |

Dimmable en PWM.

APPLICATIONS

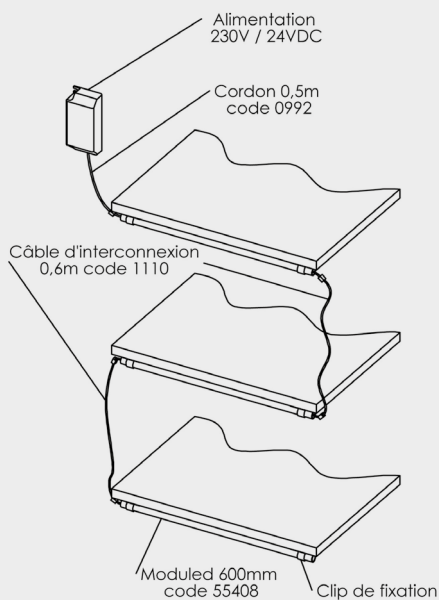

MODULED sous étagères  
3x 600 mm

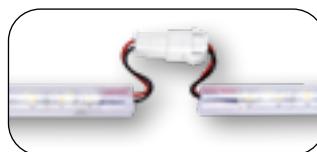

Montage en ligne continue,  
**maxi. 8 éléments par circuit d'alimentation.**



ACCESSOIRES MODULED 24

| Cordon               | Code        | € HT         |
|----------------------|-------------|--------------|
| Alimentation 0,5 m   | <b>0992</b> | <b>8,00</b>  |
| Interconnexion 0,6 m | <b>1110</b> | <b>12,20</b> |

Clips de fixation permettant l'orientation du flux lumineux

| Code         | € HT        |
|--------------|-------------|
| <b>55432</b> | <b>1,20</b> |

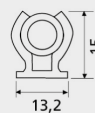

Clips de fixation permettant montage sur champ étagère verre

| Code         | € HT        |
|--------------|-------------|
| <b>55433</b> | <b>3,00</b> |

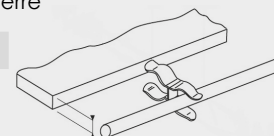

Ep. 4 à 8 mm

# MODULED 24 sur-mesure



740 lm



Tube polycarbonate dépoli Ø10 mm,  
LED SMD type 3528 (IRC > 90).  
**Élément avec continuité (2 connexions).**

Tube polycarbonate dépoli Ø10 mm,  
LED SMD type 3528 (IRC > 90).  
**Élément de terminaison (1 connexion).**

| 9,5W/m           |          | 30 000 h           |              |
|------------------|----------|--------------------|--------------|
| Lumens par mètre | Teinte   | Code au centimètre | € HT         |
| 500              | ● 2400 K | <b>55402</b>       | <b>0,80*</b> |
| 710              | ● 3000 K | <b>55403</b>       | <b>0,80*</b> |
| 740              | ○ 4200 K | <b>55404</b>       | <b>0,80*</b> |
| -                | ● bleu   | <b>55405</b>       | <b>0,80*</b> |
| -                | ● rouge  | <b>55406</b>       | <b>0,80*</b> |
| -                | ● vert   | <b>55407</b>       | <b>0,80*</b> |

| 9,5W/m           |          | 30 000 h           |              |
|------------------|----------|--------------------|--------------|
| Lumens par mètre | Teinte   | Code au centimètre | € HT         |
| 500              | ● 2400 K | <b>55412</b>       | <b>0,80*</b> |
| 710              | ● 3000 K | <b>55413</b>       | <b>0,80*</b> |
| 740              | ○ 4200 K | <b>55414</b>       | <b>0,80*</b> |
| -                | ● bleu   | <b>55415</b>       | <b>0,80*</b> |
| -                | ● rouge  | <b>55416</b>       | <b>0,80*</b> |
| -                | ● vert   | <b>55417</b>       | <b>0,80*</b> |

Montage en ligne continue, maxi. 5 m.



\* Facturation minimum 1 mètre.

\*\* Longueur entre 0,18 m à 2,03 m (module 50 mm).



● 2400 K

● 3000 K

○ 4200 K



● bleu (465 nm)

● rouge (630 nm)

● vert (520 nm)

## EXEMPLES DE MONTAGE

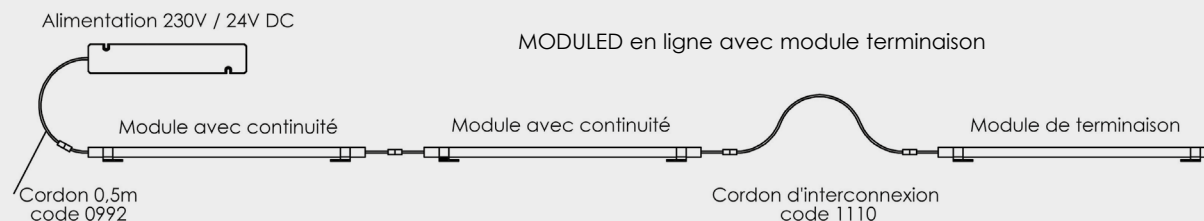

## SLIMLED



**2100 lm**

Corps aluminium/Diffuseur polycarbonate opalin, **65 LED/m**, **17,2 W/m**. Avec connecteurs. Installation multiposition.  
**Longueur maxi par circuit : 6 m.**



### Version ● 3000 K

### Version ○ 6400 K

| 30 000 h |        |        |             |               |
|----------|--------|--------|-------------|---------------|
| P (W)    | L (mm) | Lumens | Code        | € HT          |
| 6        | 310    | 330    | <b>2909</b> | <b>59,20</b>  |
| 12       | 620    | 660    | <b>2908</b> | <b>97,90</b>  |
| 18       | 930    | 980    | <b>2907</b> | <b>136,70</b> |
| 24       | 1240   | 1300   | <b>2922</b> | <b>202,00</b> |
| 30       | 1550   | 1610   | <b>2924</b> | <b>241,70</b> |
| 36       | 1860   | 1920   | <b>2926</b> | <b>266,20</b> |

| 30 000 h |        |        |             |               |
|----------|--------|--------|-------------|---------------|
| P (W)    | L (mm) | Lumens | Code        | € HT          |
| 6        | 310    | 360    | <b>2919</b> | <b>59,20</b>  |
| 12       | 620    | 720    | <b>2918</b> | <b>97,90</b>  |
| 18       | 930    | 1070   | <b>2917</b> | <b>136,70</b> |
| 24       | 1240   | 1420   | <b>2923</b> | <b>202,00</b> |
| 30       | 1550   | 1760   | <b>2925</b> | <b>241,70</b> |
| 36       | 1860   | 2100   | <b>2927</b> | <b>266,20</b> |

Dimmable en PWM.

Dimmable en PWM.

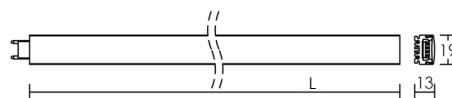
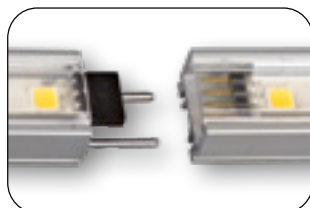

## ACCESSOIRES ET SCHÉMA DE RACCORDEMENT

|  |                                   |             |             |
|--|-----------------------------------|-------------|-------------|
|  | Désignation                       | Code        | € HT        |
|  | x1 équerre de fixation orientable | <b>0857</b> | <b>9,40</b> |

|  |                        |             |             |
|--|------------------------|-------------|-------------|
|  | Désignation            | Code        | € HT        |
|  | x2 équerre de fixation | <b>0848</b> | <b>4,70</b> |

|  |   |             |              |
|--|---|-------------|--------------|
|  | Désignation   | Code        | € HT         |
|  | Embout de branchement avec câble d'alimentation L (35 mm) x l (19 mm) | <b>2914</b> | <b>36,70</b> |

|  |   |             |             |
|--|---|-------------|-------------|
|  | Désignation                               | Code        | € HT        |
|  | Embout de fermeture L (15 mm) x l (13 mm) | <b>0589</b> | <b>8,30</b> |

|  |                        |             |              |
|--|------------------------|-------------|--------------|
|  | Désignation            | Code        | € HT         |
|  | Câble alimentation 3 m | <b>0624</b> | <b>23,70</b> |

|  |                       |             |              |
|--|-----------------------|-------------|--------------|
|  | Câble de prolongement | Code        | € HT         |
|  | 100 mm                | <b>2376</b> | <b>18,10</b> |
|  | 500 mm                | <b>2384</b> | <b>18,90</b> |

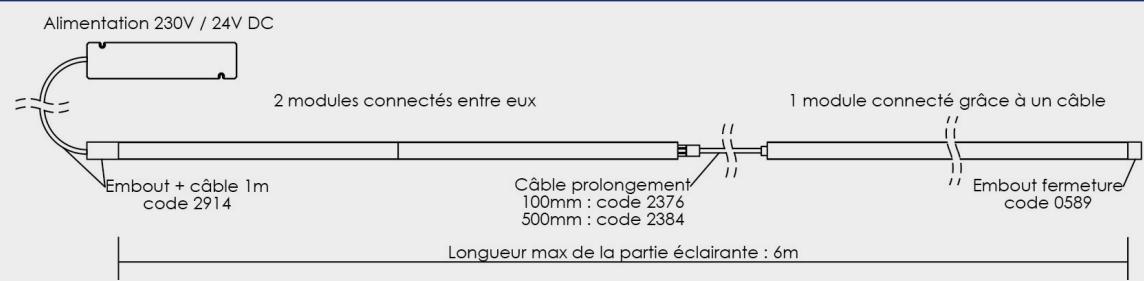

CABLED



120 lm

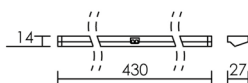
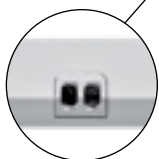

Réglette LED/Diffuseur PMMA. Eclairage des meubles/penderies avec détection infrarouge ouverture/fermeture des portes. Montage individuel.

30 000 h

| P (w) | Lumens | Teinte | Code  | € HT  |
|-------|--------|--------|-------|-------|
| 2     | 120    | 3200 K | 55800 | 59,20 |

RACCORDEMENT CABLED

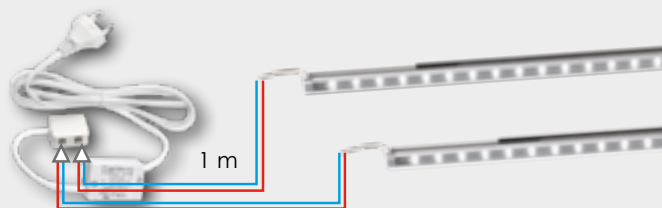

Alimentation Tension Constante 24V DC avec connexion sans outil.

| Tension | P (w) | IP | Code | € HT  |
|---------|-------|----|------|-------|
| 24V DC  | 7,2   | 20 | 0881 | 21,40 |

L x l x h : 73 x 40 x 16 mm.

LUMIRAI

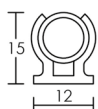
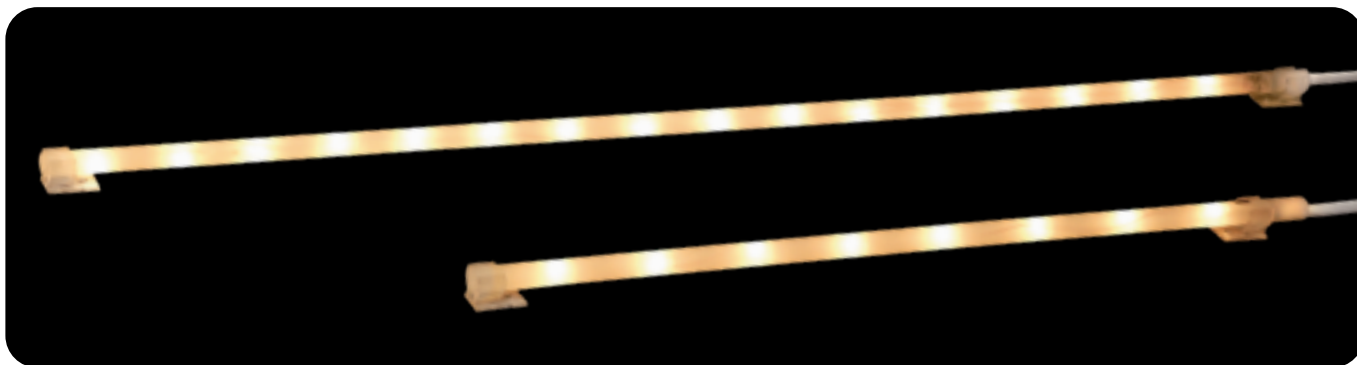

Clips de fixation permettant montage sur champ étagère verre.

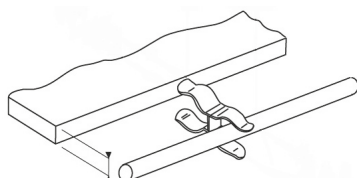

Ep. 4 à 8 mm

Tube polycarbonate rond dépoli. Lampes incandescentes en série intégrées. Clips de fixation, pose collée ou vissée et montage sur champ. Précâblage usine H03VVF 2x 0,75 mm<sup>2</sup>, 0,6 m. Fiche 6 A. Compatible avec la variation.

10 000 h

| P (w) | L (mm) | Teinte | Code | € HT  |
|-------|--------|--------|------|-------|
| 9     | 350    | 2700 K | 1062 | 31,50 |
| 18    | 550    | 2700 K | 1063 | 40,90 |

# SOMMAIRE | RUBAN PROFILÉ

## 230V DIRECT - RUBAN LED IP65 intérieur / extérieur

LYN 10 .....p. 195



LYN 14 .....p. 195



LINELED .....p. 196



LEDY 230 .....p. 197



## 24V DC - RUBAN LED IP67 intérieur / extérieur

SIDE VIEW 120 .....p. 198

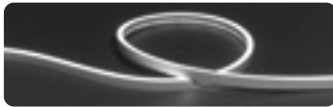

SIDE VIEW RGB .....p. 199

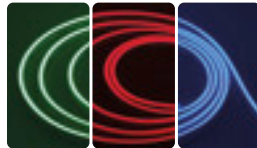

NEON 10X10 .....p. 200

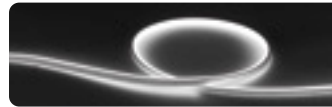

NEON DOME .....p. 201

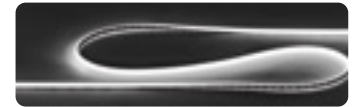

## 24V DC - RUBAN LED IP65 intérieur / extérieur

JAKLED 65 .....p. 202



JAKLED 65 RGB .....p. 203



JAKLED 60 HR .....p. 204



JAKLED 60 HR RGB .....p. 204-205



## 24V DC - RUBAN LED IP65 intérieur

FLEXI CRISTAL 120 .....p. 206



FLEXI CRISTAL 60 .....p. 207



FLEXI CRISTAL 30 .....p. 207





# SOMMAIRE | RUBAN PROFILÉ

## 24V DC - RUBAN LED IP20

PLIO .....p. 208



SIDE-EMITTING .....p. 209



FLEXO L4 .....p. 210



FLEXO L5 RGB .....p. 210



FLEXO 300 .....p. 211



FLEXO 112 .....p. 212



FLEXO 112 POWER .....p. 213



FLEXO 65 .....p. 214



FLEXO 60 HR .....p. 216



FLEXO 60 HR RGB .....p. 217



FLEXO 120 .....p. 218



FLEXO 60 .....p. 219



FLEXO 30 .....p. 220



FLEXO 120 Basse lum. ....p. 221



## ACCESSOIRES POUR RUBAN LED

PROFILÉ .....p. 222



ALIMENTATION .....p. 224



SÉQUENCEUR .....p. 225



## 230V DIRECT - RUBAN INCANDESCENT

JAKBEL sur-mesure .....p. 227



## ACCESSOIRES LYN 10 / LYN 14

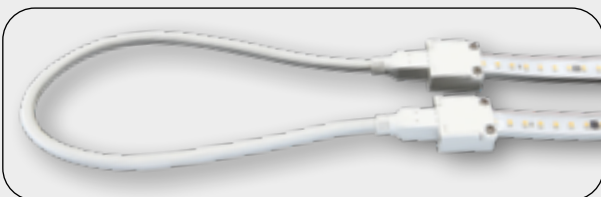

| Désignation         | Code         | € HT        |
|---------------------|--------------|-------------|
| Embout de fermeture | <b>55314</b> | <b>3,70</b> |

| Désignation  | Code         | € HT         |
|--|--------------|--------------|
| Câble d'alimentation<br>H05 RNF (IP65)<br>Longueur 1,5 m | <b>55315</b> | <b>14,20</b> |

| Désignation     | Code         | € HT         |
|-----------------|--------------|--------------|
| Connecteur en L | <b>55316</b> | <b>12,10</b> |

| Désignation                  | Code         | € HT         |
|------------------------------|--------------|--------------|
| Connecteur droit<br>(splice) | <b>55317</b> | <b>12,10</b> |

| Désignation  | Code         | € HT         |
|--|--------------|--------------|
| Câble de prolongement<br>H05 RNF (IP65)<br>Longueur 0,60 m | <b>55318</b> | <b>24,30</b> |

| Désignation   | Code         | € HT        |
|---|--------------|-------------|
| Clip de montage<br>à visser.<br>Prévoir 3 par mètre | <b>55319</b> | <b>0,50</b> |

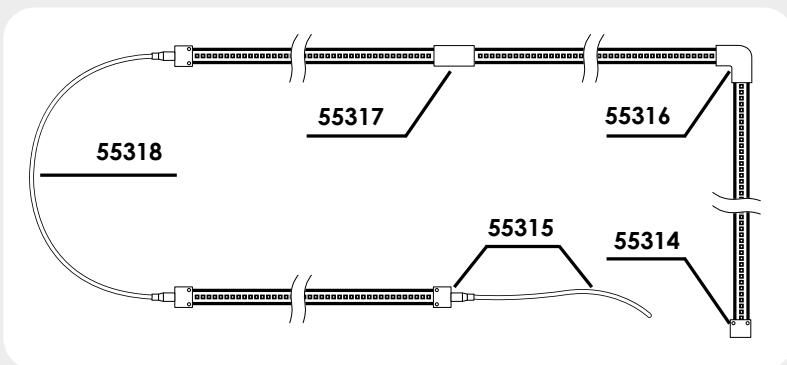

**LYN 14**

Rouleau 10 m / 20 m

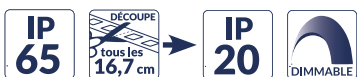

1350 lm/m

**Ruban LED « 3056 », 230V direct, 72 LED/m, 14 W/m, largeur 15,5 mm, sous gaine PVC extrudé translucide souple (IP65).**

Prêt à l'emploi avec câble d'alimentation H05RN-F précâblé 1,5 m, et embout de fermeture : IP65. Découpe possible tous les 16,7 centimètres. En cas de découpe, le produit devient IP20 (utilisation intérieure).

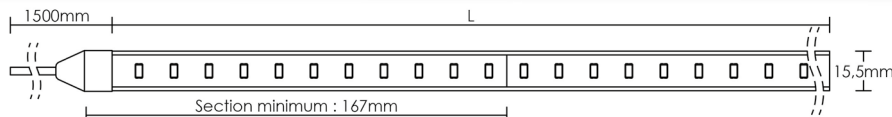

| 14 W/m |       | Câble d'alimentation fourni |      |              | 30 000 h |  |
|--------|-------|-----------------------------|------|--------------|----------|--|
| L (m)  | P (w) | Teinte                      | lm/m | Code ROULEAU | € HT     |  |
| 10     | 140   | ● 3000 K                    | 1300 | 55310        | 346,80   |  |
| 10     | 140   | ○ 4000 K                    | 1350 | 55311        | 346,80   |  |
| 20     | 280   | ● 3000 K                    | 1300 | 55312        | 632,40   |  |
| 20     | 280   | ○ 4000 K                    | 1350 | 55313        | 632,40   |  |

Dimmable sur variateur de tension à amplitude, ou à coupure de phase.

**LYN 10**

Rouleau 10 m / 20 m



750 lm/m

**Ruban LED « 3528 », 230V direct, 144 LED/m, 10 W/m, largeur 15,5 mm, sous gaine PVC extrudé translucide souple (IP65).**

Prêt à l'emploi avec câble d'alimentation H05RN-F précâblé 1,5 m, et embout de fermeture : IP65. Découpe possible tous les 50 centimètres. En cas de découpe, le produit devient IP20 (utilisation intérieure).

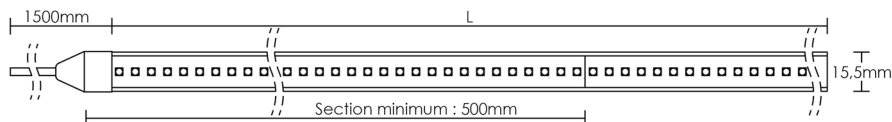

| 10 W/m |       | Câble d'alimentation fourni |      |              | 30 000 h |  |
|--------|-------|-----------------------------|------|--------------|----------|--|
| L (m)  | P (w) | Teinte                      | lm/m | Code ROULEAU | € HT     |  |
| 10     | 100   | ● 3000 K                    | 700  | 55301        | 224,40   |  |
| 10     | 100   | ○ 4000 K                    | 750  | 55302        | 224,40   |  |
| 20     | 200   | ● 3000 K                    | 700  | 55303        | 397,80   |  |
| 20     | 200   | ○ 4000 K                    | 750  | 55304        | 397,80   |  |

Dimmable sur variateur de tension à amplitude, ou à coupure de phase.

LAMPE

DOWNLIGHT ENCASTRE

RAIL PROJECTEUR SPOTIERIE

RÉGLLETTE

RUBAN



800 lm/m

Ruban LED 230V direct, 180 LED/m, 12 W/m, largeur 18 mm, sous gaine translucide souple (IP65).

Clips de fixation et bouchon de fermeture inclus. Le câble d'alimentation est vendu séparément et permet une installation de rubans jusqu'à 50 m au total, voir **code 55264**.

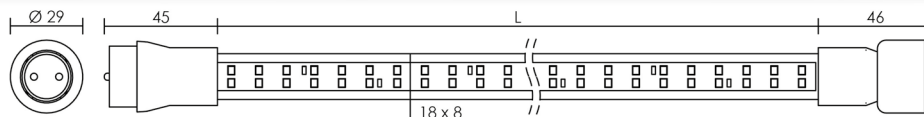

| 12 W/m |       | Câble d'alimentation non fourni |      |              | 35 000 h |  |
|--------|-------|---------------------------------|------|--------------|----------|--|
| L (m)  | P (w) | Teinte                          | lm/m | Code ROULEAU | € HT     |  |
| 1      | 12    | ● 3000 K                        | 760  | 55265        | 31,60    |  |
| 3      | 36    | ● 3000 K                        | 760  | 55266        | 75,50    |  |
| 5      | 60    | ● 3000 K                        | 760  | 55267        | 120,40   |  |
| 10     | 120   | ● 3000 K                        | 760  | 55268        | 210,10   |  |
| 1      | 12    | ○ 4000 K                        | 800  | 55260        | 31,60    |  |
| 3      | 36    | ○ 4000 K                        | 800  | 55261        | 75,50    |  |
| 5      | 60    | ○ 4000 K                        | 800  | 55262        | 120,40   |  |
| 10     | 120   | ○ 4000 K                        | 800  | 55263        | 210,10   |  |

Dimmable sur variateur de tension à amplitude, ou à coupure de phase.



Clips de fixation et bouchon inclus



### ACCESSOIRE LINELED



Câble de raccordement IP44/65, 1,5 m + prise 2P+T. Permet jusqu'à 50 m de ruban.

| Code  | € HT  |
|-------|-------|
| 55264 | 16,30 |

LEDY 230

Rouleau 30 m - 50 m

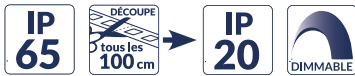

650 lm/m

Ruban LED « 2835 », 230V direct, 60 LED/m, 8 W/m, largeur 13,5 mm, sous gaine PVC extrudé translucide souple (IP65).

Prêt à l'emploi avec câble d'alimentation H05RN-F + fiche (IP44) et 2 embouts de fermeture fournis. Découpe possible tous les 1 mètre (IP65 non garanti dans ce cas).

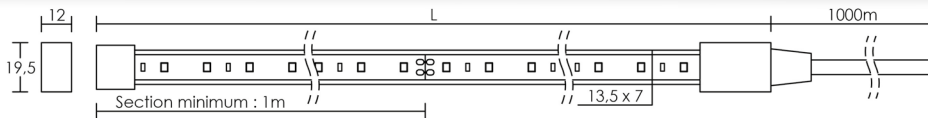

| 8 W/m       |       | Câble d'alimentation fourni |      |              | 25 000 h |  |
|-------------|-------|-----------------------------|------|--------------|----------|--|
| L (m)       | P (w) | Teinte                      | lm/m | Code ROULEAU | € HT     |  |
| 30          | 240   | 3000 K                      | 600  | 55290        | 181,00   |  |
| 30          | 240   | 4000 K                      | 650  | 55291        | 181,00   |  |
| <b>N</b> 50 | 400   | 3000 K                      | 600  | 55294        | 289,00   |  |
| <b>N</b> 50 | 400   | 4000 K                      | 650  | 55295        | 289,00   |  |

Dimmable sur variateur de tension à amplitude, ou à coupure de phase.



ACCESSOIRES LEDY 230



| Désignation  | Code  | € HT |
|--|-------|------|
| Câble d'alimentation H05RN-F avec fiche 2P 6A (IP44), longueur 1 m + 2 embouts de fermeture (classe 2, intérieur uniquement) | 55292 | 9,20 |
| Clip de montage à visser. Prévoir 3 par mètre (prix à l'unité, vendu par 10)   | 55293 | 0,40 |

SIDE VIEW 120

Rouleau 2,5 m / 5 m



470 lm/m Ruban LED « 2835 », 24V, 120 LED/m, 14 W/m, 10x18 mm, sous gaine translucide souple (IP67).

Câble d'alimentation H05RN-F 2x 0,5 mm<sup>2</sup>, lg. 35 cm, soudé aux 2 extrémités.

Installation uniquement par clips de fixation (inclus). Bouchons de fermeture fournis. Découpe possible tous les 50 mm.



**Faisceau intensif**  
diffusion de la lumière par la tranche (largeur la plus faible)



| 14 W/m       |       | Alimentation non fournie |      |              | 25 000 h      |  |
|--------------|-------|--------------------------|------|--------------|---------------|--|
| L (m)        | P (w) | Teinte                   | lm/m | Code ROULEAU | € HT          |  |
| <b>N</b> 2,5 | 35    | ● 2700 K                 | 450  | <b>55368</b> | <b>125,00</b> |  |
| <b>N</b> 2,5 | 35    | ○ 4000 K                 | 470  | <b>55369</b> | <b>125,00</b> |  |
| <b>N</b> 5   | 70    | ● 2700 K                 | 450  | <b>55370</b> | <b>247,00</b> |  |
| <b>N</b> 5   | 70    | ○ 4000 K                 | 470  | <b>55371</b> | <b>247,00</b> |  |

Dimmable en PWM.



SIDE VIEW **RGB**

Rouleau 2,5 m / 5 m



Ruban LED « 5050 », 24V, 60 LED/m, 14 W/m, 10x18 mm, sous gaine translucide souple (IP67).

Câble d'alimentation H05RN-F 4x 0,5 mm<sup>2</sup>, lg. 35 cm, soudé aux 2 extrémités.

Installation uniquement par clips de fixation (inclus). Bouchons de fermeture fournis. Découpe possible tous les 100 mm.



**Faisceau intensif**  
diffusion de la lumière par la tranche (largeur la plus faible)

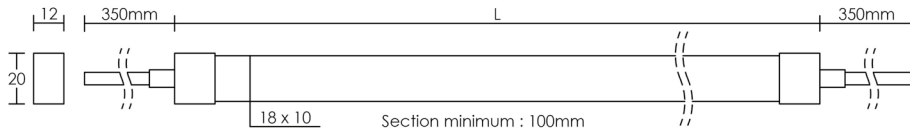

| 14 W/m       | Alimentation et séquenceur non fournis |            |  |              | 25 000 h      |
|--------------|--|------------|--|--------------|---------------|
| L (m)        | P (w)                                  | Teinte     | lm/m                                       | Code ROULEAU | € HT          |
| <b>N</b> 2,5 | 35                                     | <b>RGB</b> | <b>R</b> 50<br><b>G</b> 120<br><b>B</b> 30 | <b>55372</b> | <b>132,00</b> |
| <b>N</b> 5   | 70                                     | <b>RGB</b> | <b>R</b> 50<br><b>G</b> 120<br><b>B</b> 30 | <b>55373</b> | <b>261,00</b> |

Dimmable en PWM.

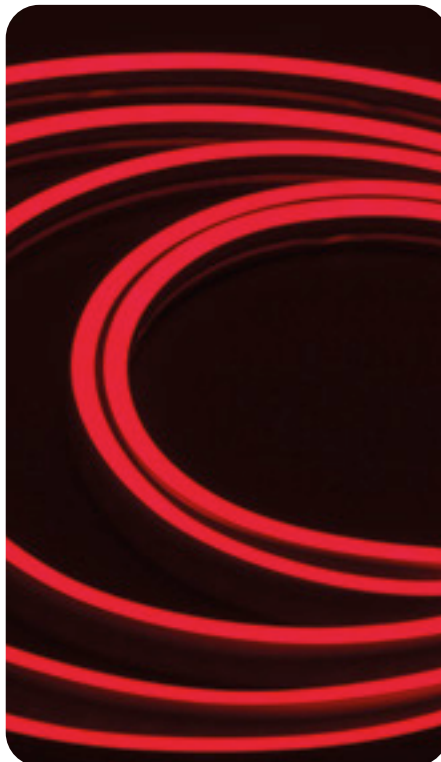

LAMPE

DOWNLIGHT ENCASTRE

RAIL PROJECTEUR SPOTIERIE

RÉGLLETTE

RUBAN

NEON 10X10

Rouleau 2,5 m / 5 m



1030 lm/m Ruban LED « 2835 », 24V, 180 LED/m, 14 W/m, 10x10 mm, sous gaine translucide souple (IP67).

Câble d'alimentation H05RN-F 2x 0,5 mm<sup>2</sup>, lg. 35 cm, soudé aux 2 extrémités.

Installation uniquement par clips de fixation (inclus). Bouchons de fermeture fournis. Découpe possible tous les 33 mm.

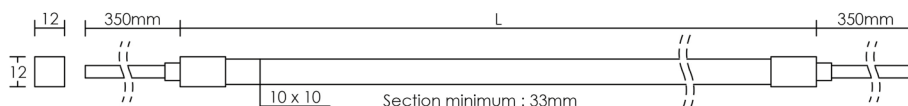
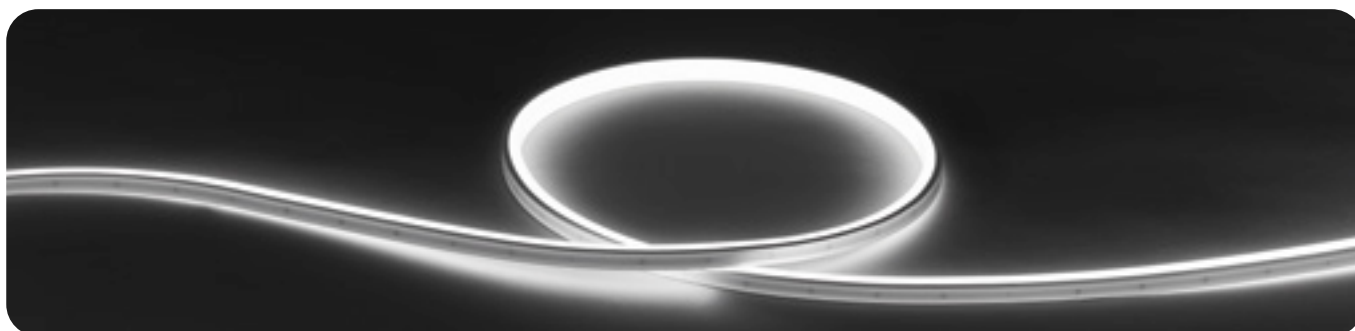

| 14 W/m       |       | Alimentation non fournie |      |              |               | 25 000 h |
|--------------|-------|--------------------------|------|--------------|---------------|----------|
| L (m)        | P (w) | Teinte                   | lm/m | Code ROULEAU | € HT          |          |
| <b>N</b> 2,5 | 35    | ● 2700 K                 | 1000 | <b>55360</b> | <b>101,00</b> |          |
| <b>N</b> 2,5 | 35    | ○ 4000 K                 | 1030 | <b>55361</b> | <b>101,00</b> |          |
| <b>N</b> 5   | 70    | ● 2700 K                 | 1000 | <b>55362</b> | <b>202,00</b> |          |
| <b>N</b> 5   | 70    | ○ 4000 K                 | 1030 | <b>55363</b> | <b>202,00</b> |          |

Dimmable en PWM.





NEON DOME

Rouleau 2,5 m / 5 m



1300 lm/m

Ruban LED « 2835 », 24V, 210 LED/m, 18 W/m, 13x7 mm, sous gaine translucide souple (IP67). Fourni avec adhésif (3M VHB). Câble d'alimentation H05RN-F 2x 0,5 mm<sup>2</sup>, lg. 35 cm, soudé aux 2 extrémités. Clips de fixation et bouchons de fermeture inclus. Découpe possible tous les 33 mm.

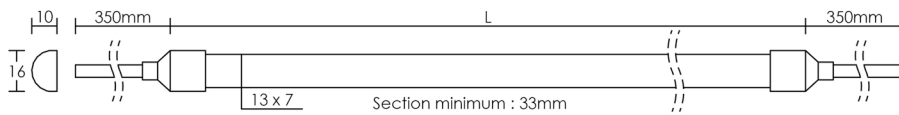
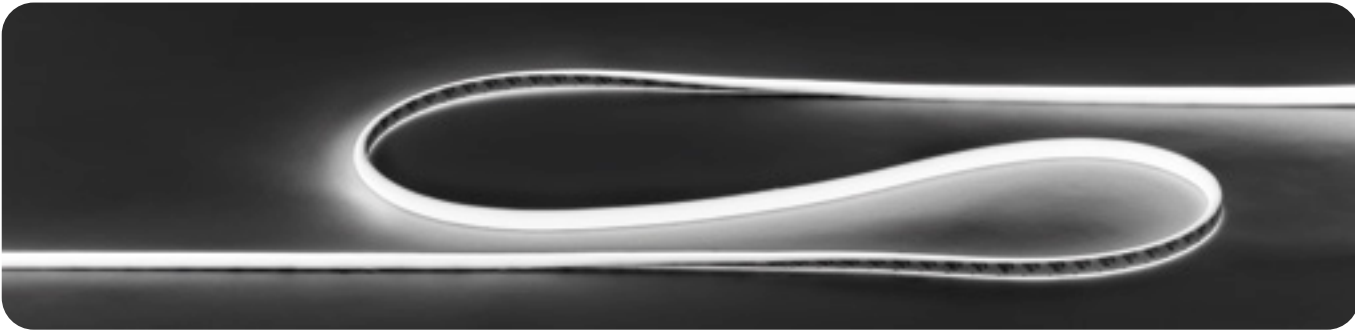

|          | 18 W/m | Alimentation non fournie |          |      |              | 25 000 h |
|----------|--------|--------------------------|----------|------|--------------|----------|
|          | L (m)  | P (w)                    | Teinte   | lm/m | Code ROULEAU | € HT     |
| <b>N</b> | 2,5    | 45                       | ● 2700 K | 1250 | 55364        | 94,00    |
| <b>N</b> | 2,5    | 45                       | ○ 4000 K | 1300 | 55365        | 94,00    |
| <b>N</b> | 5      | 90                       | ● 2700 K | 1250 | 55366        | 186,00   |
| <b>N</b> | 5      | 90                       | ○ 4000 K | 1300 | 55367        | 186,00   |

Dimmable en PWM.



LAMPE

DOWNLIGHT ENCASTRE

RAIL PROJECTEUR SPOTIERIE

RÉGLLETTE

RUBAN

JAKLED 65

Kit



1350 lm/m

Ruban LED « 2835 », 24V, 65 LED/m, 18 W/m, largeur 15,4 mm, sous gaine silicone (IP65).

Précâblé H05RN-F 2x 0,75 mm<sup>2</sup>, 1 m (extérieur). Découpe possible tous les 75 mm. Prévoir 4 cm en plus pour le raccordement. Ajouter les clips ou le profilé pour fixation.

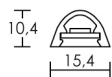
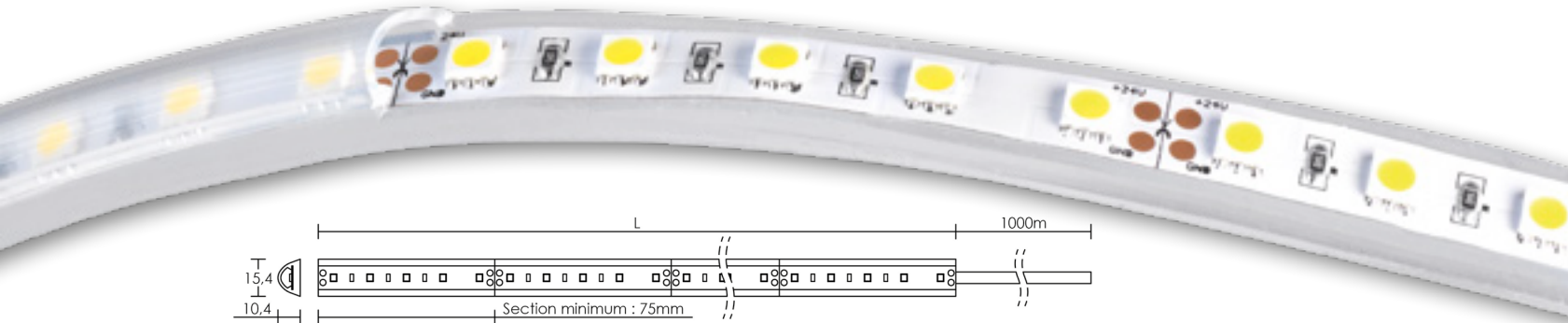

|                | 18 W/m | Alimentation IP20 fournie |        |      |          | 30 000 h |
|----------------|--------|---------------------------|--------|------|----------|----------|
| Référence      | L (m)  | P (w)                     | Teinte | lm/m | Code KIT | € HT     |
| KIT JAKLED 265 | 2      | 36                        | 3000 K | 1300 | 2390     | 187,70   |
| KIT JAKLED 265 | 2      | 36                        | 4200 K | 1320 | 55320    | 187,70   |
| KIT JAKLED 265 | 2      | 36                        | 6500 K | 1350 | 2391     | 187,70   |
| KIT JAKLED 565 | 5      | 90                        | 3000 K | 1300 | 2396     | 418,20   |
| KIT JAKLED 565 | 5      | 90                        | 4200 K | 1320 | 55323    | 418,20   |
| KIT JAKLED 565 | 5      | 90                        | 6500 K | 1350 | 2397     | 418,20   |

ACCESSOIRES JAKLED 65 / 65 RGB



Désignation Code € HT

**Clip de fixation**

Prévoir un clip à visser ou coller tous les 30 cm. **0234 1,10**

- Alimentations (p. 224)
- Module de variation (p. 224)
- Séquenceur RGB (p. 225)

• Profilés et fixations (p. 222)

|   |  |
|---|--|
| <del>PL2 : 1343</del><br>avec diffuseur                             | <del>PL3 : 1022</del><br>avec diffuseur  |
| PL4 : 1041<br>avec diffuseur  | <del>PA1 : 55097</del><br>avec diffuseur |
| <del>PE1 : 55097</del><br>avec diffuseur                            | <del>PE2 : 55098</del><br>avec diffuseur |
| <del>PM3 : 55116 (sur-mesure)<br/>55170 (1 m)<br/>55112 (2 m)</del> | <del>avec diffuseur</del>                |

JAKLED 65

Sur-mesure



Ruban LED « 2835 » / « 5050 » (RGB), 24V, 65 LED/m sous gaine silicone (IP65).  
 Livré à vos mesures. Découpe possible tous les 75 mm. Prévoir 4 cm en plus pour le raccordement.  
 Ajouter les clips ou le profilé pour fixation.



**Sur-mesure**

de 0,15 m à 5 m  
(module 75 mm)

Version standard

1350 lm/m

Précâblé H05RN-F 2x 0,75 mm<sup>2</sup>, 1 m.

| 18 W/m   | Alimentation non fournie |          |      |                       | 30 000 h      |
|--|--------------------------|----------|------|-----------------------|---------------|
| P (W/m)  | Nb. LED                  | Teinte   | lm/m | Code<br>au centimètre | € HT          |
| 18   | 65/m                     | ● 2400 K | 1060 | <b>55119</b>          | <b>1,10 *</b> |
| 18   | 65/m                     | ● 3000 K | 1300 | <b>1025</b>           | <b>1,10 *</b> |
| 18   | 65/m                     | ○ 4200 K | 1320 | <b>55120</b>          | <b>1,10 *</b> |
| 18   | 65/m                     | ○ 6400 K | 1350 | <b>1040</b>           | <b>1,10 *</b> |
| Long. de câble supplémentaire. IP65. H05RN-F 2x 0,75 mm <sup>2</sup> |                          |          |      | <b>0946</b>           | <b>0,04</b>   |

Dimmable en PWM  
 \* Facturation minimum 1 mètre.

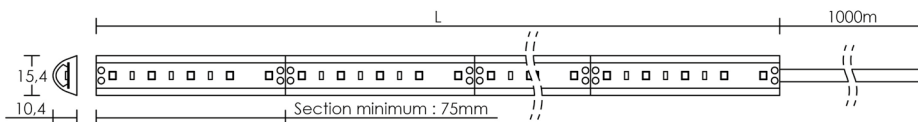

Version RGB



Précâblé H05RN-F 4x 0,5 mm<sup>2</sup>, 1 m.

| 17,2 W/m  | Alimentation non fournie |        |      |                       | 30 000 h      |
|---|--------------------------|--------|------|-----------------------|---------------|
| P (W/m)   | Nb. LED                  | Teinte | lm/m | Code<br>au centimètre | € HT          |
| 17,2  | 65/m                     | ● RGB  | -    | <b>1053</b>           | <b>1,40 *</b> |
| Long. de câble supplémentaire. IP65. H05RN-F 4x 0,5 mm <sup>2</sup> |                          |        |      | <b>0909</b>           | <b>0,10</b>   |

Dimmable en PWM  
 \* Facturation minimum 1 mètre.

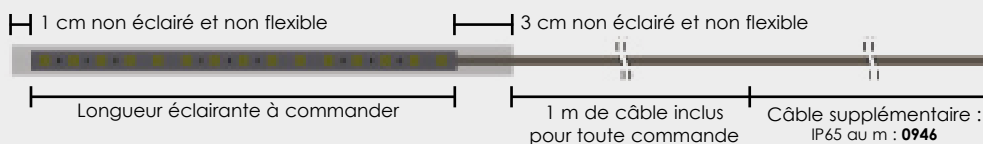
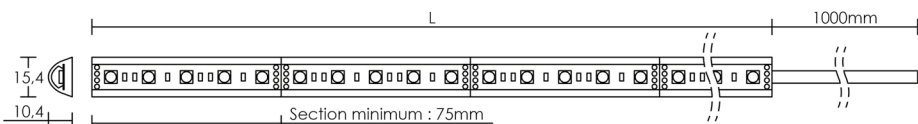

**Exemple :**

- Long. commandée : 1,20 m
- Long. livrée : 1,24 m + 1 m de câble d'alimentation.

LAMPE  
DOWNLIGHT ENCASTRE  
RAIL PROJECTEUR SPOTIERIE  
RÉGLLETTE  
RUBAN

JAKLED 60 HR

Rouleau et kit



Ruban LED « 2835 », 24V, 60 LED/m, 14,4 W/m, largeur 12 mm, sous gaine silicone (IP65).  
Fourni avec adhésif. Câble d'alimentation H05RN-F 2x 0,5 mm<sup>2</sup>, lg. 35 cm, soudé aux 2 extrémités.  
Découpe possible tous les 100 mm. Prévoir 4 cm en plus pour le raccordement.



Version standard

1170 lm/m



14,4 W/m Alimentation non fournie (rouleau) / Alimentation IP20 fournie (kit) 30 000 h

|   | L (m) | P (w) | Teinte   | lm/m | Code ROULEAU | € HT   | Code KIT | € HT   |
|---|-------|-------|----------|------|--------------|--------|----------|--------|
| N | 2,5   | 36    | ● 2700 K | 1060 | 55380        | 113,00 | 55388    | 151,00 |
| N | 2,5   | 36    | ● 3000 K | 1080 | 55381        | 113,00 | 55389    | 151,00 |
| N | 2,5   | 36    | ○ 4000 K | 1170 | 55382        | 113,00 | 55390    | 151,00 |
| N | 5     | 72    | ● 2700 K | 1060 | 55384        | 159,00 | 55392    | 227,00 |
| N | 5     | 72    | ● 3000 K | 1080 | 55385        | 159,00 | 55393    | 227,00 |
| N | 5     | 72    | ○ 4000 K | 1170 | 55386        | 159,00 | 55394    | 227,00 |

Longueur maximum 5 m.

Dimmable en PWM. Alimentation du kit non dimmable (prévoir l'ajout d'un module de variation).

Pour garantir la longévité de la qualité de l'éclairage, il est indispensable de protéger le circuit LED de toute pollution externe.

Version RGB



14,4 W/m Alimentation non fournie (rouleau) / Alimentation IP20 + séquenceur fournis (kit) 30 000 h

|   | L (m) | P (w) | Teinte | lm/m                   | Code ROULEAU | € HT   | Code KIT | € HT   |
|---|-------|-------|--------|------------------------|--------------|--------|----------|--------|
| N | 2,5   | 36    | ● RGB  | R 120<br>G 300<br>B 60 | 55383        | 130,00 | 55391    | 168,00 |
| N | 5     | 72    | ● RGB  | R 120<br>G 300<br>B 60 | 55387        | 194,00 | 55395    | 261,00 |

Longueur maximum 5 m.

Dimmable en PWM. Alimentation du kit non dimmable (prévoir l'ajout d'un module de variation).

Pour garantir la longévité de la qualité de l'éclairage, il est indispensable de protéger le circuit LED de toute pollution externe.

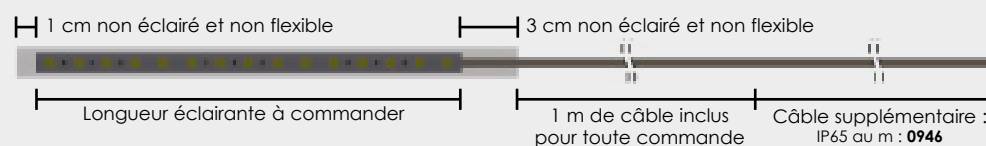

Exemple :

- Long. commandée : 1,20 m
- Long. livrée : 1,24 m + 1 m de câble d'alimentation.

JAKLED 60 HR

Sur-mesure



Ruban LED « 2835 » / « 5050 » (RGB), 24V, 60 LED/m, 14,4 W/m, largeur 12 mm, sous gaine silicone (IP65).  
Livré à vos mesures. Découpe possible tous les 100 mm. Prévoir 4 cm en plus pour le raccordement. Fourni avec adhésif

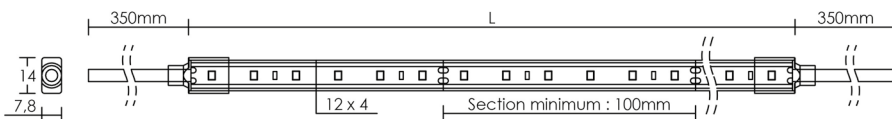
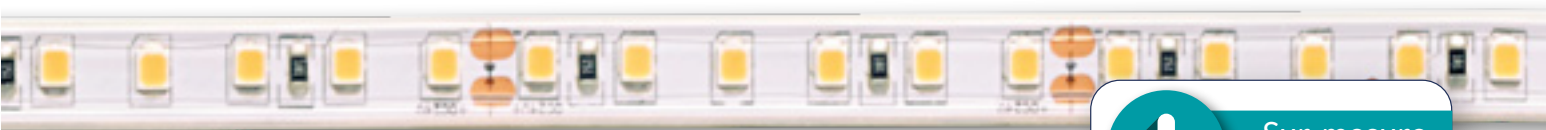

**+** Sur-mesure  
de 0,20 m à 5 m  
(module 100 mm)

Version standard

1170 lm/m

Câble d'alimentation H05RN-F 2x 0,5 mm<sup>2</sup>, lg. 35 cm, soudé aux 2 extrémités.

| Alimentation non fournie |  |         |        |      |                    | 30 000 h |
|--------------------------|--|---------|--------|------|--------------------|----------|
|                          | P (W/m)  | Nb. LED | Teinte | lm/m | Code au centimètre | € HT     |
| <b>N</b>                 | 14,4   | 60/m    | 2700 K | 1060 | 55396              | 0,45 *   |
| <b>N</b>                 | 14,4   | 60/m    | 3000 K | 1080 | 55397              | 0,45 *   |
| <b>N</b>                 | 14,4   | 60/m    | 4000 K | 1170 | 55398              | 0,45 *   |
|                          | Long. de câble supplémentaire. IP65. H05RN-F 2x 0,50 mm <sup>2</sup> |         |        |      | 55400              | 0,04     |

Dimmable en PWM  
\* Facturation minimum 1 mètre.

Version RGB



Câble d'alimentation H05RN-F 4x 0,5 mm<sup>2</sup>, lg. 35 cm, soudé aux 2 extrémités.

| Alimentation non fournie |   |         |        |                        |                    | 30 000 h |
|--------------------------|---|---------|--------|------------------------|--------------------|----------|
|                          | P (W/m)   | Nb. LED | Teinte | lm/m                   | Code au centimètre | € HT     |
| <b>N</b>                 | 14,4  | 60/m    | RGB    | R 120<br>G 300<br>B 60 | 55399              | 0,80 *   |
|                          | Long. de câble supplémentaire. IP65. H05RN-F 4x 0,5 mm <sup>2</sup> |         |        |                        | 0909               | 0,10     |

Dimmable en PWM  
\* Facturation minimum 1 mètre.

ACCESSOIRES JAKLED 60 HR / 60 HR RGB

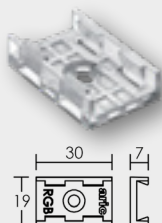

Désignation Code € HT  
**Clip de fixation**  
Prévoir un clip à visser ou coller tous les 30 cm.  
2377 1,10

- Alimentations (p. 224)
- Module de variation (p. 224)
- Séquenceur RGB (p. 225)

• Profilés et fixations (p. 222)

|   |   |  |   |
|---|---|--|---|
| <del>PL2 : 1343</del><br><br>avec diffuseur | <del>PL3 : 1022</del><br><br>avec diffuseur | PL4 : 1041<br>   | <del>PA1 : 5509</del><br><br>avec diffuseur |
| <del>PE1 : 5509</del><br><br>avec diffuseur | <del>PE2 : 5508</del><br><br>avec diffuseur | <del>PM3 :</del><br>55116 (sur-mesure)<br>55110 (1 m)<br>55112 (2 m) | <del></del>                                 |

**FLEXI CRISTAL 120**

Rouleau



740 lm/m

Ruban LED « 3528 », 120 LED/m, 9,5 W/m, largeur 8 mm, sous gaine translucide (IP65). Fourni avec adhésif. Précâblé LIYY - 2x 0,5 mm<sup>2</sup>, 1 m. Découpe possible tous les 50 mm.

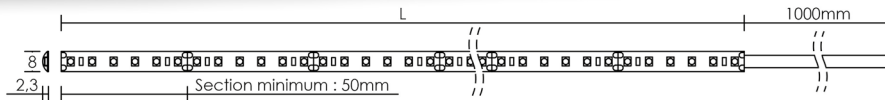

La bande FLEXI CRISTAL est IP65, son câble d'alimentation est IP20. Prévoir le raccordement dans une boîte protégée pour assurer un IP supérieur à 20.



| 9,5 W/m |       | Alimentation non fournie |      |              | 30 000 h |  |
|---------|-------|--------------------------|------|--------------|----------|--|
| L (m)   | P (w) | Teinte                   | lm/m | Code ROULEAU | € HT     |  |
| 2,5     | 24    | ● 3000 K                 | 710  | 55058        | 96,90    |  |
| 2,5     | 24    | ○ 4200 K                 | 740  | 55059        | 96,90    |  |
| 2,5     | 24    | ● bleu (465 nm)          | -    | 55060        | 96,90    |  |
| 5       | 48    | ● 3000 K                 | 710  | 55061        | 174,40   |  |
| 5       | 48    | ○ 4200 K                 | 740  | 55062        | 174,40   |  |
| 5       | 48    | ● bleu (465 nm)          | -    | 55063        | 174,40   |  |

Dimmable en PWM.

**ACCESSOIRES FLEXI 30 / 60 / 120**

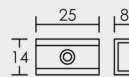







Désignation Code € HT

**Clip de fixation pour FLEXI 30/60**  
Prévoir un clip à visser ou coller tous les 30 cm.  
55049 1,10

- Alimentations (p. 224)
- Module de variation (p. 224)

• Profilés et fixations (p. 222)

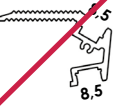
|   |   |
|---|---|
| <del>PL2 : 1343</del><br><br>avec diffuseur  | PL3 : 1022<br>                               |
| <del>PL4 : 1041</del><br><br>avec diffuseur  | <del>PA1 : 55097</del><br><br>avec diffuseur |
| <del>PE1 : 55097</del><br><br>avec diffuseur | <del>PE2 : 55098</del><br><br>avec diffuseur |
| <del>PM3 :<br/>55116 (sur-mesure)<br/>55110 (1 m)<br/>55112 (2 m)</del>   | <del></del>                                  |

## FLEXI CRISTAL 60

Rouleau



380 lm/m

Ruban LED « 3528 », 60 LED/m, 4,6 W/m, largeur 10 mm, sous gaine translucide (IP65). Fourni avec adhésif. Précâblé LIYY - 2x 0,5 mm<sup>2</sup>, 1 m. Découpe possible tous les 100 mm.

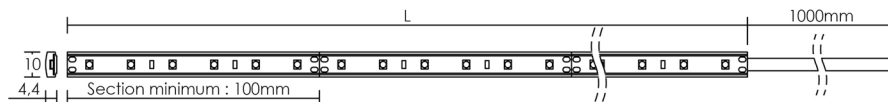

La bande FLEXI CRISTAL est IP65, son câble d'alimentation est IP20. Prévoir le raccordement dans une boîte protégée pour assurer un IP supérieur à 20.



| 4,6 W/m |       | Alimentation non fournie |      |              | 30 000 h |  |
|---------|-------|--------------------------|------|--------------|----------|--|
| L (m)   | P (w) | Teinte                   | lm/m | Code ROULEAU | € HT     |  |
| 2,5     | 11,5  | ● 3000 K                 | 340  | 55054        | 78,50    |  |
| 2,5     | 11,5  | ○ 4200 K                 | 380  | 55055        | 78,50    |  |
| 5       | 23    | ● 3000 K                 | 340  | 55056        | 131,60   |  |
| 5       | 23    | ○ 4200 K                 | 380  | 55057        | 131,60   |  |

Dimmable en PWM.

## FLEXI CRISTAL 30

Rouleau



155 lm/m

Ruban LED « 3528 », 30 LED/m, 2,6 W/m, largeur 8 mm, sous gaine translucide (IP65). Fourni avec adhésif. Précâblé LIYY - 2x 0,5 mm<sup>2</sup>, 1 m. Découpe possible tous les 167 mm.

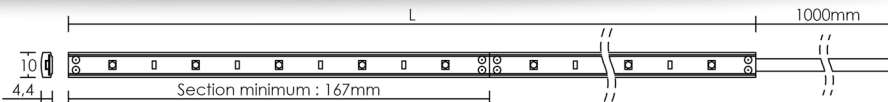

La bande FLEXI CRISTAL est IP65, son câble d'alimentation est IP20. Prévoir le raccordement dans une boîte protégée pour assurer un IP supérieur à 20.



| 2,6 W/m |       | Alimentation non fournie |      |              | 30 000 h |  |
|---------|-------|--------------------------|------|--------------|----------|--|
| L (m)   | P (w) | Teinte                   | lm/m | Code ROULEAU | € HT     |  |
| 2,5     | 6,5   | ● 3000 K                 | 145  | 55050        | 66,30    |  |
| 2,5     | 6,5   | ○ 4200 K                 | 155  | 55051        | 66,30    |  |
| 5       | 13    | ● 3000 K                 | 145  | 55052        | 109,10   |  |
| 5       | 13    | ○ 4200 K                 | 155  | 55053        | 109,10   |  |

Dimmable en PWM.

PLIO 24V

Rouleau 5 m



1200 lm/m

Ruban LED, 24V, 60 LED/m, 14,4 W/m, largeur 6 mm.  
Fourni avec adhésif (3M VHB). Câble d'alimentation 2x 0,5 mm<sup>2</sup>, lg. 35 cm, soudé aux 2 extrémités.  
Découpe possible tous les 62,5 mm, voir repère « ciseau ».



**+** Super flexible  
il pourra s'adapter PARTOUT

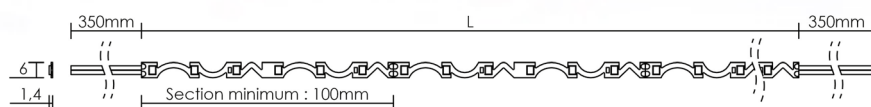

| 14,4 W/m |       | Alimentation non fournie |          |      | 25 000 h     |       |
|----------|-------|--------------------------|----------|------|--------------|-------|
|          | L (m) | P (w)                    | Teinte   | lm/m | Code ROULEAU | € HT  |
| <b>N</b> | 5     | 72                       | ● 2700 K | 1120 | 55348        | 79,50 |
| <b>N</b> | 5     | 72                       | ○ 4000 K | 1200 | 55349        | 79,50 |





SIDE-EMITTING 24V

Rouleau 5 m



570 lm/m

Ruban LED, 24V, 96 LED/m, 7,6 W/m, largeur 8 mm.  
Fourni avec adhésif. Câble d'alimentation 2x 0,5 mm<sup>2</sup>, lg. 35 cm, soudé aux 2 extrémités.  
Découpe possible tous les 62,5 mm, voir repère « ciseau ».

**Ambiance**  
Lumière émise sur la tranche du ruban pour éclairage d'ambiance.

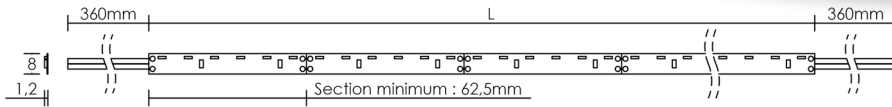
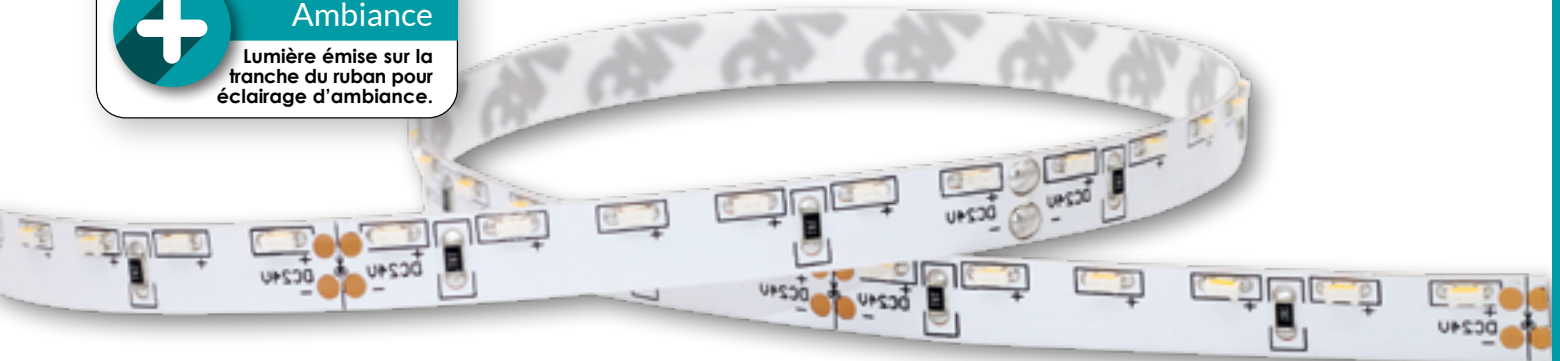

| 7,6 W/m    |       | Alimentation non fournie |      |              | 25 000 h |  |
|------------|-------|--------------------------|------|--------------|----------|--|
| L (m)      | P (w) | Teinte                   | lm/m | Code ROULEAU | € HT     |  |
| <b>N</b> 5 | 38    | 2700 K                   | 550  | 55350        | 102,00   |  |
| <b>N</b> 5 | 38    | 4000 K                   | 570  | 55351        | 102,00   |  |

ACCESSOIRES SIDE-EMITTING

|   | Désignation                            | Code  | € HT |
|---|--|-------|------|
| <b>Connexions 2 fils pour ruban largeur 8 mm</b>  |  |       |      |
|   | Alimentation précâblée 50 cm           | 55330 | 4,00 |
|   | Raccord entre 2 rubans précâblé 15 cm  | 55331 | 3,30 |
|   | Raccord en ligne - Sans câble (direct) | 55332 | 1,10 |
| <b>Connexions 2 fils SLIM pour ruban largeur 8 mm</b><br>Permet l'installation dans un profilé de 10 mm       |  |       |      |
|   | Alimentation précâblée 50 cm           | 55333 | 4,10 |
|   | Raccord entre 2 rubans précâblé 15 cm  | 55334 | 2,30 |
|   | Raccord en ligne - Sans câble (direct) | 55335 | 1,10 |
| <b>Connexions CMV pour ruban largeur 8 mm</b><br>Permet l'installation du ruban seul ou avec profilé de 10 mm |  |       |      |
|   | Connexion en L (2 voies)               | 55336 | 0,20 |
|   | Connexion en T (3 voies)               | 55337 | 0,20 |

• Profilés et fixations (p. 222)

|   |                            |
|---|----------------------------|
| <del>PL2 : 1343</del><br>   | <del>PL3 : 1022</del><br>  |
| <del>PL4 : 1041</del><br>   | <del>PA1 : 55097</del><br> |
| <del>PE1 : 55097</del><br>  | <del>PE2 : 55098</del><br> |
| <del>PM3 : 55116 (sur-mesure)<br/>55110 (1 m)<br/>55112 (2 m)</del><br> |                            |

- Alimentations (p. 224)
- Module de variation (p. 224)

## FLEXO L4

Rouleau 5 m



1440 lm/m

Ruban LED « 2110 », 24V, 120 LED/m, 7,2 W/m, largeur 4 mm.  
Fourni avec adhésif (3M VHB). Installation sur profilé aluminium préconisée. Câble d'alimentation 2x 0,5 mm<sup>2</sup>, lg. 35 cm, soudé aux 2 extrémités. Découpe possible tous les 50 mm, voir repère « ciseau ».



**+** **Passé-partout**  
grâce à sa largeur réduite.

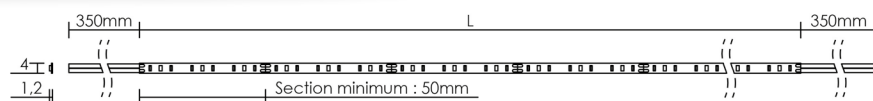

|   |       | 7,2 W/m | Alimentation non fournie |      |              | 25 000 h |
|---|-------|---------|--------------------------|------|--------------|----------|
|   | L (m) | P (w)   | Teinte                   | lm/m | Code ROULEAU | € HT     |
| N | 5     | 36      | 2700 K                   | 1200 | 55353        | 50,00    |
| N | 5     | 36      | 4000 K                   | 1440 | 55354        | 50,00    |

## FLEXO L5 RGB

Rouleau 2,5 m



Ruban LED « 3838 », 24V, 120 LED/m, 9,6 W/m, largeur 5 mm.  
Fourni avec adhésif. Installation sur profilé aluminium préconisée. Câble d'alimentation 4x 0,5 mm<sup>2</sup>, lg. 35 cm, soudé aux 2 extrémités. Découpe possible tous les 50 mm, voir repère « ciseau ».



**+** **L'extra-fin**  
version RGB

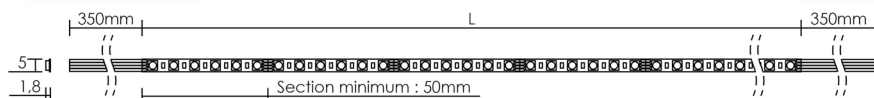

|   |       | 9,6 W/m | Alimentation non fournie |                       |              | 25 000 h |
|---|-------|---------|--------------------------|-----------------------|--------------|----------|
|   | L (m) | P (w)   | Teinte                   | lm/m                  | Code ROULEAU | € HT     |
| N | 2,5   | 24      | RGB                      | R 80<br>G 380<br>B 80 | 55352        | 63,00    |

**FLEXO 300**

Rouleau 5 m



1440 lm/m

Ruban LED « 2110 », 24V, 300 LED/m, 18 W/m, largeur 10 mm.  
Fourni avec adhésif (3M VHB). Installation sur profilé aluminium préconisée. Câble d'alimentation 2x 0,5 mm<sup>2</sup>, lg. 35 cm, soudé aux 2 extrémités. Découpe possible tous les 20 mm, voir repère « ciseau ».

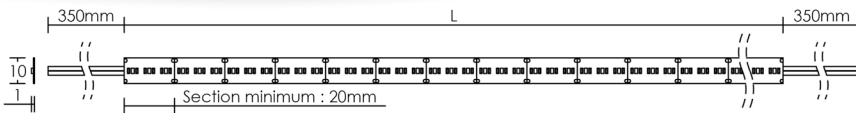

| 18 W/m     |       | Alimentation non fournie |      |              | 25 000 h |  |
|------------|-------|--------------------------|------|--------------|----------|--|
| L (m)      | P (w) | Teinte                   | lm/m | Code ROULEAU | € HT     |  |
| <b>N</b> 5 | 90    | ● 2700 K                 | 1200 | 55355        | 120,00   |  |
| <b>N</b> 5 | 90    | ○ 4000 K                 | 1440 | 55356        | 120,00   |  |

**ACCESSOIRES FLEXO 300**

|   | Désignation                            | Code  | € HT |
|---|--|-------|------|
| <b>Connexions 2 fils pour ruban largeur 10 mm</b>   |  |       |      |
|   | Alimentation précâblée 50 cm           | 55001 | 1,90 |
|   | Raccord entre 2 rubans précâblé 15 cm  | 55003 | 2,20 |
|   | Raccord en ligne - Sans câble (direct) | 55340 | 1,20 |
| <b>Connexions CMV pour ruban largeur 10 mm</b><br>Permet l'installation du ruban seul ou avec profilé |  |       |      |
|   | Connexion en L (2 voies)               | 55341 | 0,20 |
|   | Connexion en T (3 voies)               | 55342 | 0,20 |

• Profilés et fixations (p. 222)

|  |  |
|--|--|
| <b>PL2 : 1343</b><br><br>avec diffuseur                          | <b>PL3 : 1022</b><br><br>avec diffuseur  |
| <b>PL4 : 1041</b><br><br>avec diffuseur                          | <b>PA1 : 55097</b><br><br>avec diffuseur |
| <b>PE1 : 55091</b><br><br>avec diffuseur                         | <b>PE2 : 55093</b><br><br>avec diffuseur |
| <b>PM3 :</b><br>55116 (sur-mesure)<br>55110 (1 m)<br>55112 (2 m) |  |

- Alimentations (p. 224)
- Module de variation (p. 224)

LAMPE

DOWNLIGHT ENCASTRE

RAIL PROJECTEUR SPOTIERIE

RÉGLLETTE

RUBAN

**FLEXO 112**

Rouleau et kit



1750 lm/m

Ruban LED « 2835 », 24V, 112 LED/m, 16,8 W/m, largeur 10 mm.  
Fourni avec adhésif. Installation sur profilé aluminium préconisée. Précâblé LIYY 2x 0,5 mm<sup>2</sup>, 1 m.  
Découpe possible tous les 71,4 mm, voir repère « ciseau ». Une connexion supplémentaire (55001) incluse.»

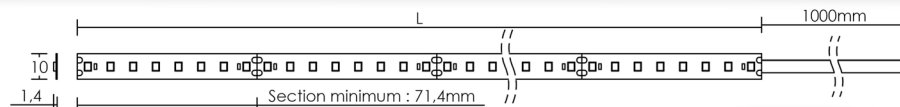

| 16,8 W/m |       | Alimentation non fournie (rouleau) / Alimentation IP20 fournie (kit) |      |              |        | 30 000 h |        |
|----------|-------|--|------|--------------|--------|----------|--------|
| L (m)    | P (w) | Teinte   | lm/m | Code ROULEAU | € HT   | Code KIT | € HT   |
| 2,5      | 42    | ● 3000 K   | 1680 | 55270        | 71,20  | 55274    | 134,60 |
| 2,5      | 42    | ○ 4000 K   | 1750 | 55271        | 71,20  | 55275    | 134,60 |
| 5        | 84    | ● 3000 K   | 1680 | 55272        | 142,50 | 55276    | 274,40 |
| 5        | 84    | ○ 4000 K   | 1750 | 55273        | 142,50 | 55277    | 274,40 |

Longueur maximum 5 m.  
Dimmable en PWM. Alimentation du kit non dimmable (prévoir l'ajout d'un module de variation).  
Pour garantir la longévité de la qualité de l'éclairage, il est indispensable de protéger le circuit LED de toute pollution externe.

**ACCESSOIRES FLEXO 112**

|   | Désignation                            | Code  | € HT |
|---|--|-------|------|
| <b>Connexions 2 fils pour ruban largeur 10 mm</b>   |  |       |      |
|   | Alimentation précâblée 50 cm           | 55001 | 1,90 |
|   | Raccord entre 2 rubans précâblé 15 cm  | 55003 | 2,20 |
|   | Raccord en ligne - Sans câble (direct) | 55340 | 1,20 |
| <b>Connexions CMV pour ruban largeur 10 mm</b><br>Permet l'installation du ruban seul ou avec profilé |  |       |      |
|   | Connexion en L (2 voies)               | 55341 | 0,20 |
|   | Connexion en T (3 voies)               | 55342 | 0,20 |

• Profilés et fixations (p. 222)

|  |  |
|--|--|
| <b>PL2 : 1343</b><br><br>avec diffuseur                          | <b>PL3 : 1022</b><br><br>avec diffuseur  |
| <b>PL4 : 1041</b><br><br>avec diffuseur                          | <b>PA1 : 55097</b><br><br>avec diffuseur |
| <b>PE1 : 55091</b><br><br>avec diffuseur                         | <b>PE2 : 55093</b><br><br>avec diffuseur |
| <b>PM3 :</b><br>55116 (sur-mesure)<br>55110 (1 m)<br>55112 (2 m) |  |

- Alimentations (p. 224)
- Module de variation (p. 224)

**FLEXO 112 POWER**

Rouleau et kit



2700 lm/m

Ruban LED « 5630 », 24V, 112 LED/m, 19,2 W/m, largeur 10 mm.  
Fourni avec adhésif. Installation sur profilé aluminium préconisée. Précâblé LIYY 2x 0,5 mm<sup>2</sup>, 1 m.  
Découpe possible tous les 71,4 mm, voir repère « ciseau ». Une connexion supplémentaire (55001) incluse.

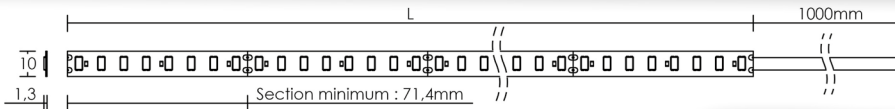

19,2 W/m Alimentation non fournie (rouleau) / Alimentation IP20 fournie (kit) 30 000 h

| L (m) | P (w) | Teinte | lm/m | Code ROULEAU | € HT   | Code KIT | € HT   |
|-------|-------|--------|------|--------------|--------|----------|--------|
| 2,5   | 48    | 3000 K | 2500 | 55278        | 109,00 | 55282    | 179,50 |
| 2,5   | 48    | 4000 K | 2700 | 55279        | 109,00 | 55283    | 179,50 |
| 5     | 96    | 3000 K | 2500 | 55280        | 218,10 | 55284    | 345,80 |
| 5     | 96    | 4000 K | 2700 | 55281        | 218,10 | 55285    | 345,80 |

Longueur maximum 5 m.  
Dimmable en PWM. Alimentation du kit non dimmable (prévoir l'ajout d'un module de variation).  
Pour garantir la longévité de la qualité de l'éclairage, il est indispensable de protéger le circuit LED de toute pollution externe.

**ACCESSOIRES FLEXO 112 POWER**

|   | Désignation                            | Code  | € HT |
|---|--|-------|------|
| <b>Connexions 2 fils pour ruban largeur 10 mm</b>   |  |       |      |
|   | Alimentation précâblée 50 cm           | 55001 | 1,90 |
|   | Raccord entre 2 rubans précâblé 15 cm  | 55003 | 2,20 |
|   | Raccord en ligne - Sans câble (direct) | 55340 | 1,20 |
| <b>Connexions CMV pour ruban largeur 10 mm</b><br>Permet l'installation du ruban seul ou avec profilé |  |       |      |
|   | Connexion en L (2 voies)               | 55341 | 0,20 |
|   | Connexion en T (3 voies)               | 55342 | 0,20 |

• Profilés et fixations (p. 222)

|  |  |
|--|--|
| <b>PL2 : 1343</b><br><br>avec diffuseur                          | <b>PL3 : 1022</b><br><br>avec diffuseur  |
| <b>PL4 : 1041</b><br><br>avec diffuseur                          | <b>PA1 : 55097</b><br><br>avec diffuseur |
| <b>PE1 : 55091</b><br><br>avec diffuseur                         | <b>PE2 : 55093</b><br><br>avec diffuseur |
| <b>PM3 :</b><br>55116 (sur-mesure)<br>55110 (1 m)<br>55112 (2 m) | <br>8,5                                  |

- Alimentations (p. 224)
- Module de variation (p. 224)

**FLEXO 65**

Rouleau et kit



1400 lm/m

Ruban LED « 2835 », 24V, 65 LED/m, 18 W/m, largeur 10 mm.

Fourni avec adhésif. Installation sur profilé aluminium préconisée.

Câble LIYY 2x 0,5 mm² 1 m soudé. Découpe possible tous les 75 mm, voir repère « ciseau ».

Une connexion supplémentaire (55001) incluse.

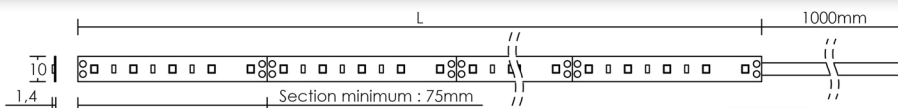
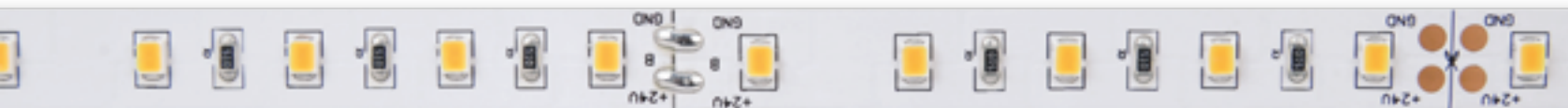

18 W/m Alimentation non fournie (rouleau) / Alimentation IP20 fournie (kit) 30 000 h

| L (m) | P (w) | Teinte   | lm/m | Code ROULEAU | € HT   | Code KIT | € HT   |
|-------|-------|----------|------|--------------|--------|----------|--------|
| 2     | 36    | ● 2400 K | 1100 | 55070        | 83,60  | 55200    | 101,00 |
| 2     | 36    | ● 3000 K | 1350 | 55033        | 83,60  | 55201    | 101,00 |
| 2     | 36    | ○ 4200 K | 1370 | 55034        | 83,60  | 55202    | 101,00 |
| 2     | 36    | ○ 6500 K | 1400 | 55035        | 83,60  | 55203    | 101,00 |
| 5     | 90    | ● 2400 K | 1100 | 55073        | 146,90 | 55214    | 263,20 |
| 5     | 90    | ● 3000 K | 1350 | 55075        | 146,90 | 55215    | 263,20 |
| 5     | 90    | ○ 4200 K | 1370 | 55076        | 146,90 | 55216    | 263,20 |
| 5     | 90    | ○ 6500 K | 1400 | 55077        | 146,90 | 55217    | 263,20 |

Longueur maximum 5 m.

Dimmable en PWM. Alimentation du kit non dimmable (prévoir l'ajout d'un module de variation).

Pour garantir la longévité de la qualité de l'éclairage, il est indispensable de protéger le circuit LED de toute pollution externe.

**ACCESSOIRES FLEXO 65**

|   | Désignation                            | Code  | € HT |
|---|--|-------|------|
| <b>Connexions 2 fils pour ruban largeur 10 mm</b>   |  |       |      |
|   | Alimentation précâblée 50 cm           | 55001 | 1,90 |
|   | Raccord entre 2 rubans précâblé 15 cm  | 55003 | 2,20 |
|   | Raccord en ligne - Sans câble (direct) | 55340 | 1,20 |
| <b>Connexions CMV pour ruban largeur 10 mm</b><br>Permet l'installation du ruban seul ou avec profilé |  |       |      |
|   | Connexion en L (2 voies)               | 55341 | 0,20 |
|   | Connexion en T (3 voies)               | 55342 | 0,20 |

- Alimentations (p. 224)
- Module de variation (p. 224)

• Profilés et fixations (p. 222)

|                              |                              |                              |                               |                               |                               |   |  |
|------------------------------|------------------------------|------------------------------|-------------------------------|-------------------------------|-------------------------------|---|--|
| PL2 : 1343<br>avec diffuseur | PL3 : 1022<br>avec diffuseur | PL4 : 1041<br>avec diffuseur | PA1 : 55097<br>avec diffuseur | PE1 : 55091<br>avec diffuseur | PE2 : 55093<br>avec diffuseur | PM3 :<br>55116 (sur-mesure)<br>55110 (1 m)<br>55112 (2 m) |  |
|------------------------------|------------------------------|------------------------------|-------------------------------|-------------------------------|-------------------------------|---|--|

**FLEXO 65 RGB**

Rouleau et kit



**Ruban LED « 5050 », 24V, 65 LED/m, 17,2 W/m, largeur 10 mm.**  
 Fourni avec adhésif. Installation sur profilé aluminium préconisée.  
 Câble LIYY 4x 0,5 mm<sup>2</sup> 1 m soudé. Découpe possible tous les 75 mm, voir repère « ciseau ».  
 Une connexion supplémentaire (55004) incluse.

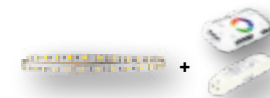
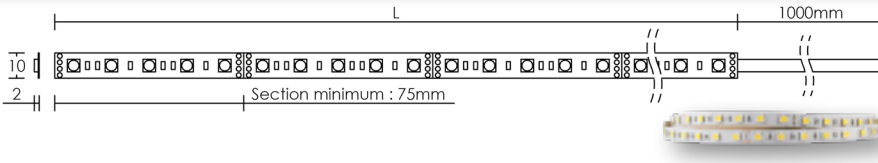

| 17,2 W/m |       | Alimentation non fournie (rouleau) / Alimentation IP20 + séquenceur fournis (kit) |      |              |        | 30 000 h |        |
|----------|-------|---|------|--------------|--------|----------|--------|
| L (m)    | P (w) | Teinte  | lm/m | Code ROULEAU | € HT   | Code KIT | € HT   |
| 2        | 35    | RGB   | -    | 55048        | 108,10 | 55219    | 228,50 |
| 5        | 87    | RGB   | -    | 55078        | 244,80 | 55218    | 430,40 |

Longueur maximum 5 m.  
 Dimmable en PWM. Alimentation du kit non dimmable (prévoir l'ajout d'un module de variation).  
 Pour garantir la longévité de la qualité de l'éclairage, il est indispensable de protéger le circuit LED de toute pollution externe.

**ACCESSOIRES FLEXO 65 RGB**

|   | Désignation                            | Code  | € HT |
|---|--|-------|------|
| <b>Connexions 4 fils pour ruban RGB largeur 10 mm</b> |  |       |      |
|   | Alimentation précâblée 50 cm           | 55004 | 1,90 |
|   | Raccord entre 2 rubans précâblé 15 cm  | 55006 | 2,80 |
|   | Raccord en ligne - Sans câble (direct) | 55345 | 1,20 |

• **Profilés et fixations** (p. 222)

|  |  |
|--|--|
| <b>PL2 : 1343</b><br><br>10,8<br>avec diffuseur                  | <b>PL3 : 1022</b><br><br>10,8<br>avec diffuseur  |
| <b>PL4 : 1041</b><br><br>13,5<br>avec diffuseur                  | <b>PA1 : 55097</b><br><br>10,3<br>avec diffuseur |
| <b>PE1 : 55091</b><br><br>12,3<br>avec diffuseur                 | <b>PE2 : 55093</b><br><br>12,4<br>avec diffuseur |
| <b>PM3 :</b><br>55116 (sur-mesure)<br>55110 (1 m)<br>55112 (2 m) | <br>8,5  |

- Alimentations (p. 224)
- Module de variation (p. 224)
- Séquenceur RGB (p. 225)

LAMPE

DOWNLIGHT ENCASTRE

RAIL PROJECTEUR SPOTIERIE

RÉGLLETTE

RUBAN

FLEXO 60 HR

Rouleau et kit



1300 lm/m

Ruban LED « 2835 », 24V, 60 LED/m, 14,4 W/m, largeur 10 mm.  
Fourni avec adhésif. Installation sur profilé aluminium préconisée. Câble d'alimentation 2x 0,5 mm<sup>2</sup>, lg. 35 cm, soudé aux 2 extrémités. Découpe possible tous les 100 mm, voir repère « ciseau ».

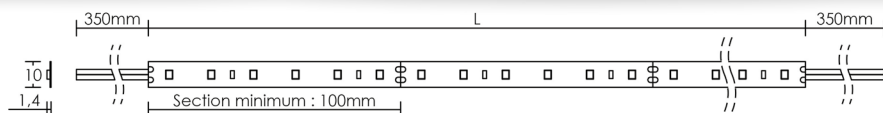

14,4 W/m Alimentation non fournie (rouleau) / Alimentation IP20 fournie (kit) 30 000 h

| L (m) | P (w) | Teinte | lm/m | Code ROULEAU | € HT  | Code KIT | € HT   |
|-------|-------|--------|------|--------------|-------|----------|--------|
| N 2,5 | 36    | 2700 K | 1180 | 55190        | 51,00 | 55220    | 89,00  |
| N 2,5 | 36    | 3000 K | 1200 | 55191        | 51,00 | 55221    | 89,00  |
| N 2,5 | 36    | 4000 K | 1300 | 55192        | 51,00 | 55222    | 89,00  |
| N 5   | 72    | 2700 K | 1180 | 55194        | 84,00 | 55224    | 147,00 |
| N 5   | 72    | 3000 K | 1200 | 55195        | 84,00 | 55225    | 147,00 |
| N 5   | 72    | 4000 K | 1300 | 55196        | 84,00 | 55226    | 147,00 |

Longueur maximum 5 m.

Dimmable en PWM. Alimentation du kit non dimmable (prévoir l'ajout d'un module de variation).

Pour garantir la longévité de la qualité de l'éclairage, il est indispensable de protéger le circuit LED de toute pollution externe.

ACCESSOIRES FLEXO 60 HR

| Désignation   | Code  | € HT |
|---|-------|------|
| <b>Connexions 2 fils pour ruban largeur 10 mm</b>   |       |      |
| Alimentation précâblée 50 cm  | 55001 | 1,90 |
| Raccord entre 2 rubans précâblé 15 cm   | 55003 | 2,20 |
| Raccord en ligne - Sans câble (direct)  | 55340 | 1,20 |
| <b>Connexions CMV pour ruban largeur 10 mm</b><br>Permet l'installation du ruban seul ou avec profilé |       |      |
| Connexion en L (2 voies)  | 55341 | 0,20 |
| Connexion en T (3 voies)  | 55342 | 0,20 |

- Alimentations (p. 224)
- Module de variation (p. 224)

• Profilés et fixations (p. 222)

|                              |                              |                              |                               |                               |                               |   |
|------------------------------|------------------------------|------------------------------|-------------------------------|-------------------------------|-------------------------------|---|
| PL2 : 1343<br>avec diffuseur | PL3 : 1022<br>avec diffuseur | PL4 : 1041<br>avec diffuseur | PA1 : 55097<br>avec diffuseur | PE1 : 55091<br>avec diffuseur | PE2 : 55093<br>avec diffuseur | PM3 :<br>55116 (sur-mesure)<br>55110 (1 m)<br>55112 (2 m)<br> |
|------------------------------|------------------------------|------------------------------|-------------------------------|-------------------------------|-------------------------------|---|



**FLEXO 60 HR RGB**

Rouleau et kit



Ruban LED « 5050 », 24V, 60 LED/m, 14,4 W/m, largeur 10 mm.  
Fourni avec adhésif. Installation sur profilé aluminium préconisée. Câble d'alimentation 4x 0,5 mm<sup>2</sup>, lg. 35 cm, soudé aux 2 extrémités. Découpe possible tous les 100 mm, voir repère « ciseau ».

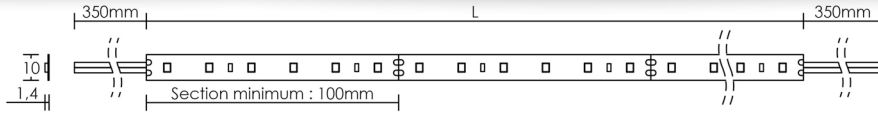

| 14,4 W/m |       | Alimentation non fournie (rouleau) / Alimentation IP20 + séquenceur fournis (kit) |                        |              |        | 30 000 h |        |
|----------|-------|---|------------------------|--------------|--------|----------|--------|
| L (m)    | P (w) | Teinte  | lm/m                   | Code ROULEAU | € HT   | Code KIT | € HT   |
| 2,5      | 36    | RGB   | R 130<br>G 330<br>B 70 | 55193        | 69,00  | 55223    | 106,00 |
| 5        | 72    | RGB   | R 130<br>G 330<br>B 70 | 55197        | 119,00 | 55227    | 182,00 |

Longueur maximum 5 m.

Dimmable en PWM. Alimentation du kit non dimmable (prévoir l'ajout d'un module de variation).

Pour garantir la longévité de la qualité de l'éclairage, il est indispensable de protéger le circuit LED de toute pollution externe.

**ACCESSOIRES FLEXO 60 HR RGB**

|   | Désignation                            | Code  | € HT |
|---|--|-------|------|
| <b>Connexions 4 fils pour ruban RGB largeur 10 mm</b> |  |       |      |
|   | Alimentation précâblée 50 cm           | 55004 | 1,90 |
|   | Raccord entre 2 rubans précâblé 15 cm  | 55006 | 2,80 |
|   | Raccord en ligne - Sans câble (direct) | 55345 | 1,20 |

- Alimentations (p. 224)
- Module de variation (p. 224)
- Séquenceur RGB (p. 225)

• Profils et fixations (p. 222)

|   |   |   |  |  |  |  |  |
|---|---|---|--|--|--|--|--|
| <b>PL2 : 1343</b><br><br>avec diffuseur | <b>PL3 : 1022</b><br><br>avec diffuseur | <b>PL4 : 1041</b><br><br>avec diffuseur | <b>PA1 : 55097</b><br><br>avec diffuseur | <b>PE1 : 55091</b><br><br>avec diffuseur | <b>PE2 : 55093</b><br><br>avec diffuseur | <b>PM3 :</b><br>55116 (sur-mesure)<br>55110 (1 m)<br>55112 (2 m) |  |
|---|---|---|--|--|--|--|--|

**FLEXO 120**

Rouleau et kit



840 lm/m

Ruban LED « 2835 », 24V, 120 LED/m, 9,5 W/m, largeur 8 mm.  
Fourni avec adhésif. Installation sur profilé aluminium préconisée. Câble d'alimentation 2x 0,5 mm<sup>2</sup>, lg. 35 cm, soudé aux 2 extrémités. Découpe possible tous les 50 mm, voir repère « ciseau ».

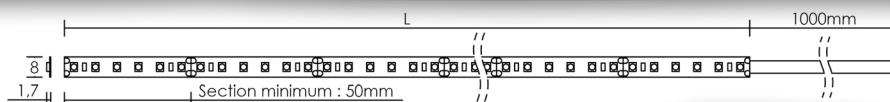

| 9,5 W/m |       | Alimentation non fournie (rouleau) / Alimentation IP20 fournie (kit) |                |              |       |          | 30 000 h |        |
|---------|-------|--|----------------|--------------|-------|----------|----------|--------|
| L (m)   | P (w) | Teinte   | lm/m           | Code ROULEAU | € HT  | Code KIT | € HT     |        |
| N       | 2,5   | 23   | 2400 K         | 680          | 55080 | 76,50    | 55243    | 108,10 |
|         | 2,5   | 24   | 2700 K         | 760          | 55121 | 59,00    | 55252    | 88,00  |
|         | 2,5   | 24   | 3000 K         | 800          | 55023 | 76,50    | 55244    | 108,10 |
|         | 2,5   | 24   | 4000 K         | 840          | 55024 | 76,50    | 55245    | 108,10 |
| N       | 5     | 46   | 2400 K         | 680          | 55081 | 122,40   | 55249    | 182,60 |
|         | 5     | 48   | 2700 K         | 760          | 55122 | 99,00    | 55253    | 137,00 |
|         | 5     | 48   | 3000 K         | 800          | 55028 | 122,40   | 55250    | 182,60 |
|         | 5     | 48   | 4000 K         | 840          | 55029 | 122,40   | 55251    | 182,60 |
|         | 5     | 48   | bleu (460 nm)  | -            | 55030 | 122,40   |          |        |
|         | 5     | 48   | rouge (620 nm) | -            | 55031 | 122,40   |          |        |
|         | 5     | 48   | vert (520 nm)  | -            | 55032 | 122,40   |          |        |

Longueur maximum 5 m. Dimmable en PWM. Alimentation du kit non dimmable (prévoir l'ajout d'un module de variation). Pour garantir la longévité de la qualité de l'éclairage, il est indispensable de protéger le circuit LED de toute pollution externe.

**ACCESSOIRES FLEXO 120**

|   | Désignation                            | Code  | € HT |
|---|--|-------|------|
| <b>Connexions 2 fils pour ruban largeur 8 mm</b>  |  |       |      |
|   | Alimentation précâblée 50 cm           | 55330 | 4,00 |
|   | Raccord entre 2 rubans précâblé 15 cm  | 55331 | 3,30 |
|   | Raccord en ligne - Sans câble (direct) | 55332 | 1,10 |
| <b>Connexions 2 fils SLIM pour ruban largeur 8 mm</b><br>Permet l'installation dans un profilé de 10 mm       |  |       |      |
|   | Alimentation précâblée 50 cm           | 55333 | 4,10 |
|   | Raccord entre 2 rubans précâblé 15 cm  | 55334 | 2,30 |
|   | Raccord en ligne - Sans câble (direct) | 55335 | 1,10 |
| <b>Connexions CMV pour ruban largeur 8 mm</b><br>Permet l'installation du ruban seul ou avec profilé de 10 mm |  |       |      |
|   | Connexion en L (2 voies)               | 55336 | 0,20 |
|   | Connexion en T (3 voies)               | 55337 | 0,20 |

• Profilés et fixations (p. 222)

|  |  |
|--|--|
| <b>PL2 : 1343</b><br><br>avec diffuseur                              | <b>PL3 : 1022</b><br><br>avec diffuseur  |
| <b>PL4 : 1041</b><br><br>avec diffuseur                              | <b>PA1 : 55097</b><br><br>avec diffuseur |
| <b>PE1 : 55091</b><br><br>avec diffuseur                             | <b>PE2 : 55093</b><br><br>avec diffuseur |
| <b>PM3 :</b><br>55116 (sur-mesure)<br>55110 (1 m)<br>55112 (2 m)<br> |  |

- Alimentations (p. 224)
- Module de variation (p. 224)

**FLEXO 60**

Rouleau et kit



420 lm/m

Ruban LED « 2835 », 24V, 60 LED/m, 4,6 W/m, largeur 8 mm.  
Fourni avec adhésif. Installation sur profilé aluminium préconisée. Câble d'alimentation 2x 0,5 mm<sup>2</sup>, lg. 35 cm, soudé aux 2 extrémités. Découpe possible tous les 100 mm, voir repère « ciseau ».

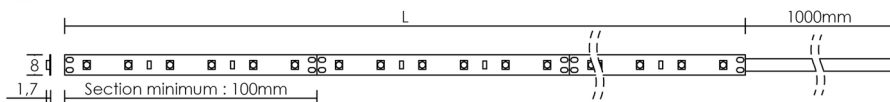

4,6 W/m Alimentation non fournie (rouleau) / Alimentation IP20 fournie (kit) 30 000 h

| L (m) | P (w) | Teinte   | lm/m | Code ROULEAU | € HT  | Code KIT | € HT   |
|-------|-------|----------|------|--------------|-------|----------|--------|
| N 2,5 | 11,5  | ● 2700 K | 380  | 55123        | 45,00 | 55246    | 74,00  |
|       |       | ● 3000 K | 400  | 55019        | 61,20 | 55239    | 94,90  |
|       |       | ○ 4000 K | 420  | 55020        | 61,20 | 55240    | 94,90  |
| N 5   | 23    | ● 2700 K | 380  | 55124        | 71,00 | 55247    | 99,60  |
|       |       | ● 3000 K | 400  | 55021        | 89,80 | 55241    | 121,40 |
|       |       | ○ 4000 K | 420  | 55022        | 89,80 | 55242    | 121,40 |

Longueur maximum 5 m.

Dimmable en PWM. Alimentation du kit non dimmable (prévoir l'ajout d'un module de variation).

Pour garantir la longévité de la qualité de l'éclairage, il est indispensable de protéger le circuit LED de toute pollution externe.

**ACCESSOIRES FLEXO 60**

|   | Désignation                            | Code  | € HT |
|---|--|-------|------|
| <b>Connexions 2 fils pour ruban largeur 8 mm</b>  |  |       |      |
|   | Alimentation précâblée 50 cm           | 55330 | 4,00 |
|   | Raccord entre 2 rubans précâblé 15 cm  | 55331 | 3,30 |
|   | Raccord en ligne - Sans câble (direct) | 55332 | 1,10 |
| <b>Connexions 2 fils SLIM pour ruban largeur 8 mm</b><br>Permet l'installation dans un profilé de 10 mm       |  |       |      |
|   | Alimentation précâblée 50 cm           | 55333 | 4,10 |
|   | Raccord entre 2 rubans précâblé 15 cm  | 55334 | 2,30 |
|   | Raccord en ligne - Sans câble (direct) | 55335 | 1,10 |
| <b>Connexions CMV pour ruban largeur 8 mm</b><br>Permet l'installation du ruban seul ou avec profilé de 10 mm |  |       |      |
|   | Connexion en L (2 voies)               | 55336 | 0,20 |
|   | Connexion en T (3 voies)               | 55337 | 0,20 |

• Profilés et fixations (p. 222)

|  |  |
|--|--|
| <b>PL2 : 1343</b><br><br>avec diffuseur                              | <b>PL3 : 1022</b><br><br>avec diffuseur  |
| <b>PL4 : 1041</b><br><br>avec diffuseur                              | <b>PA1 : 55097</b><br><br>avec diffuseur |
| <b>PE1 : 55091</b><br><br>avec diffuseur                             | <b>PE2 : 55093</b><br><br>avec diffuseur |
| <b>PM3 :</b><br>55116 (sur-mesure)<br>55110 (1 m)<br>55112 (2 m)<br> |  |

- Alimentations (p. 224)
- Module de variation (p. 224)

**FLEXO 30**

Rouleau et kit



210 lm/m

Ruban LED « 2835 », 24V, 30 LED/m, 2,6 W/m, largeur 8 mm.  
Fourni avec adhésif. Installation sur profilé aluminium préconisée. Câble d'alimentation 2x 0,5 mm<sup>2</sup>, lg. 35 cm, soudé aux 2 extrémités. Découpe possible tous les 167 mm, voir repère « ciseau ».

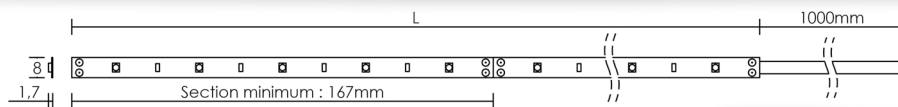
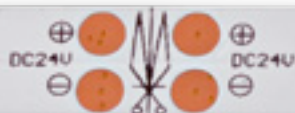

| 2,6 W/m |       | Alimentation non fournie (rouleau) / Alimentation IP20 fournie (kit) |        |              |       | 30 000 h |       |        |
|---------|-------|--|--------|--------------|-------|----------|-------|--------|
| L (m)   | P (w) | Teinte   | lm/m   | Code ROULEAU | € HT  | Code KIT | € HT  |        |
| N       | 5     | 13   | 2700 K | 190          | 55125 | 60,00    | 55229 | 85,00  |
|         | 5     | 13   | 3000 K | 200          | 55012 | 76,50    | 55233 | 109,10 |
|         | 5     | 13   | 4000 K | 210          | 55013 | 76,50    | 55234 | 109,10 |
| N       | 10    | 26   | 2700 K | 190          | 55126 | 89,00    | 55232 | 114,00 |
|         | 10    | 26   | 3000 K | 200          | 55014 | 125,50   | 55236 | 155,00 |
|         | 10    | 26   | 4000 K | 210          | 55015 | 125,50   | 55237 | 155,00 |

Longueur maximum 10 m.

Dimmable en PWM. Alimentation du kit non dimmable (prévoir l'ajout d'un module de variation).

Pour garantir la longévité de la qualité de l'éclairage, il est indispensable de protéger le circuit LED de toute pollution externe.

**ACCESSOIRES FLEXO 30**

|   | Désignation                            | Code  | € HT |
|---|--|-------|------|
| <b>Connexions 2 fils pour ruban largeur 8 mm</b>  |  |       |      |
|   | Alimentation précâblée 50 cm           | 55330 | 4,00 |
|   | Raccord entre 2 rubans précâblé 15 cm  | 55331 | 3,30 |
|   | Raccord en ligne - Sans câble (direct) | 55332 | 1,10 |
| <b>Connexions 2 fils SLIM pour ruban largeur 8 mm</b><br>Permet l'installation dans un profilé de 10 mm       |  |       |      |
|   | Alimentation précâblée 50 cm           | 55333 | 4,10 |
|   | Raccord entre 2 rubans précâblé 15 cm  | 55334 | 2,30 |
|   | Raccord en ligne - Sans câble (direct) | 55335 | 1,10 |
| <b>Connexions CMV pour ruban largeur 8 mm</b><br>Permet l'installation du ruban seul ou avec profilé de 10 mm |  |       |      |
|   | Connexion en L (2 voies)               | 55336 | 0,20 |
|   | Connexion en T (3 voies)               | 55337 | 0,20 |

• Profilés et fixations (p. 222)

|   |                                   |
|---|-----------------------------------|
| PL2 : 1343<br><br>avec diffuseur                          | PL3 : 1022<br><br>avec diffuseur  |
| PL4 : 1041<br><br>avec diffuseur                          | PA1 : 55097<br><br>avec diffuseur |
| PE1 : 55091<br><br>avec diffuseur                         | PE2 : 55093<br><br>avec diffuseur |
| PM3 :<br>55116 (sur-mesure)<br>55110 (1 m)<br>55112 (2 m) | <br>8,5<br>8,5                    |

• Alimentations (p. 224)

• Module de variation (p. 224)

**FLEXO 120 basse luminosité**

Rouleau et kit

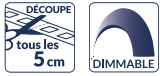

20 lm/m

Ruban LED « 2835 », 24V, 120 LED/m, 0,25 W/m, largeur 8 mm.  
Fourni avec adhésif. Installation sur profilé aluminium préconisée. Câble d'alimentation LIYY 2x 0,5 mm<sup>2</sup>, lg. 1 m.  
Découpe possible tous les 50 mm, voir repère « ciseau ».

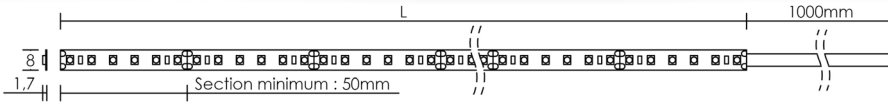

**+** Idéal balisage  
et soulignement  
de l'architecture



| 0,25 W/m |       | Alimentation non fournie (rouleau) / Alimentation IP20 fournie (kit) |      |              |        | 30 000 h |        |
|----------|-------|--|------|--------------|--------|----------|--------|
| L (m)    | P (w) | Teinte   | lm/m | Code ROULEAU | € HT   | Code KIT | € HT   |
| 5        | 1,5   | ⓑ 2400 K   | 20   | 55083        | 142,80 | 55256    | 157,10 |
| 10       | 3     | ⓑ 2400 K   | 20   | 55084        | 247,90 | 55257    | 257,00 |

Longueur maximum 10 m.  
Dimmable en PWM. Alimentation du kit non dimmable (prévoir l'ajout d'un module de variation).  
Pour garantir la longévité de la qualité de l'éclairage, il est indispensable de protéger le circuit LED de toute pollution externe.

**ACCESSOIRES FLEXO 120 basse luminosité**

|   | Désignation                            | Code  | € HT |
|---|--|-------|------|
| <b>Connexions 2 fils pour ruban largeur 8 mm</b>  |  |       |      |
|   | Alimentation précâblée 50 cm           | 55330 | 4,00 |
|   | Raccord entre 2 rubans précâblé 15 cm  | 55331 | 3,30 |
|   | Raccord en ligne - Sans câble (direct) | 55332 | 1,10 |
| <b>Connexions 2 fils SLIM pour ruban largeur 8 mm</b><br>Permet l'installation dans un profilé de 10 mm       |  |       |      |
|   | Alimentation précâblée 50 cm           | 55333 | 4,10 |
|   | Raccord entre 2 rubans précâblé 15 cm  | 55334 | 2,30 |
|   | Raccord en ligne - Sans câble (direct) | 55335 | 1,10 |
| <b>Connexions CMV pour ruban largeur 8 mm</b><br>Permet l'installation du ruban seul ou avec profilé de 10 mm |  |       |      |
|   | Connexion en L (2 voies)               | 55336 | 0,20 |
|   | Connexion en T (3 voies)               | 55337 | 0,20 |

• Profilés et fixations (p. 222)

|  |  |
|--|--|
| <b>PL2 : 1343</b><br><br>avec diffuseur                              | <b>PL3 : 1022</b><br><br>avec diffuseur  |
| <b>PL4 : 1041</b><br><br>avec diffuseur                              | <b>PA1 : 55097</b><br><br>avec diffuseur |
| <b>PE1 : 55091</b><br><br>avec diffuseur                             | <b>PE2 : 55093</b><br><br>avec diffuseur |
| <b>PM3 :</b><br>55116 (sur-mesure)<br>55110 (1 m)<br>55112 (2 m)<br> |  |

- Alimentations (p. 224)
- Module de variation (p. 224)

## PE1 - 2 mètres



Vendu en longueur de 2 m avec diffuseur opale\*.  
Embouts à **commander séparément**.

| Désignation  | Code         | € HT         |
|--------------|--------------|--------------|
| Profilé PE 1 | <b>55091</b> | <b>76,40</b> |
| Embout       | <b>55092</b> | <b>2,30</b>  |

\* Taux d'absorption du diffuseur 35%.

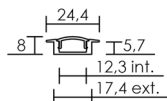

## PE2 - 2 mètres



Vendu en longueur de 2 m avec diffuseur opale\*.  
Embouts à **commander séparément**.

| Désignation  | Code         | € HT         |
|--------------|--------------|--------------|
| Profilé PE 2 | <b>55093</b> | <b>72,10</b> |
| Embout       | <b>55094</b> | <b>2,60</b>  |

\* Taux d'absorption du diffuseur 35%.

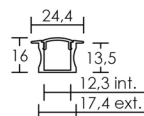

## PA1 - Profilé d'angle - 2 mètres



Vendu en longueur de 2 m. Profilé d'angle avec diffuseur opale et embouts.

| Couleur   | Code         | € HT         |
|-----------|--------------|--------------|
| aluminium | <b>55097</b> | <b>96,90</b> |



## PL2 - 2 mètres



Vendu en longueur de 2 m avec diffuseur opalin et embouts.  
Se coupe selon utilisation.

| Couleur   | Code        | € HT         |
|-----------|-------------|--------------|
| aluminium | <b>1343</b> | <b>48,00</b> |

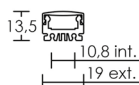

## PL3 - 2 mètres



Vendu en longueur de 2 m.  
Se coupe selon utilisation.

| Couleur   | Code        | € HT         |
|-----------|-------------|--------------|
| aluminium | <b>1022</b> | <b>33,10</b> |

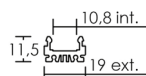

## PL4 - 2 mètres



Vendu en longueur de 2 m.  
Se coupe selon utilisation.  
(tenue par clipsage silicone dans le profilé alu.)

| Couleur   | Code        | € HT         |
|-----------|-------------|--------------|
| aluminium | <b>1041</b> | <b>19,30</b> |

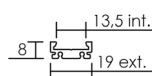

## ÉQUERRES DE FIXATION pour PL 2



| Désignation  | Code        | € HT        |
|--------------|-------------|-------------|
| équerre fixe | <b>0848</b> | <b>4,70</b> |

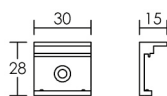

| Désignation        | Code        | € HT        |
|--------------------|-------------|-------------|
| équerre orientable | <b>0857</b> | <b>9,40</b> |

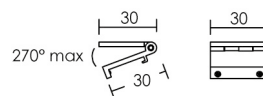

PM 3 - Nez de marche



**Profilé aluminium pour rubans LED largeur 8 mm.**

Double émission de lumière. Eclairage diffusant vers le haut et vers le bas.  
Stries antidérapantes.

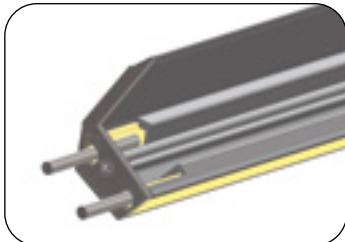
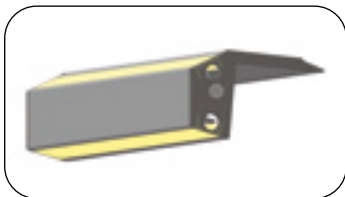

Possibilité de sortie de câble latérale.

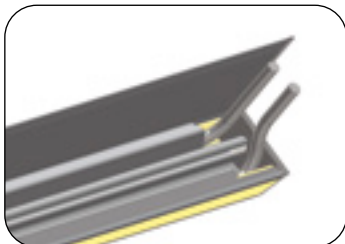

Possibilité de sortie de câble arrière.

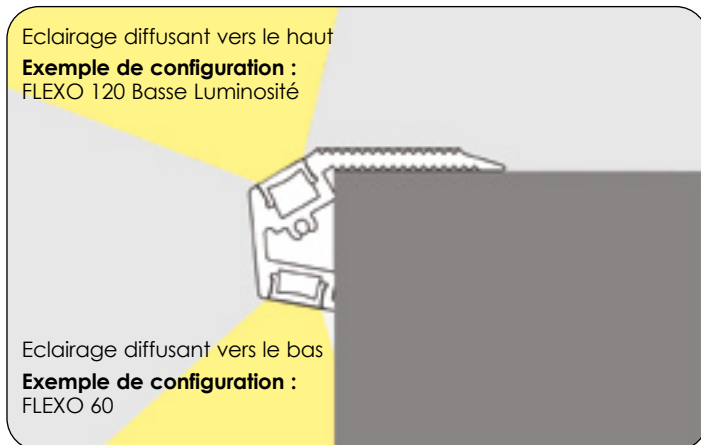

Version sur-mesure

**+** Sur-mesure   
de 0,1 m à 3 m

| Couleur | Code<br>au centimètre | € HT |
|---------|-----------------------|------|
| gris    | 55116                 | 0,80 |

Version standard

| L (mètre) | Code  | € HT  |
|-----------|-------|-------|
| 1         | 55110 | 53,00 |
| 2         | 55112 | 79,60 |

ACCESSOIRE PM3



Embout de fermeture incolore.

| Code  | € HT |
|-------|------|
| 55118 | 2,00 |

LAMPE

DOWNLIGHT  
ENCASTRE

RAIL  
PROJECTEUR  
SPOTIERIE



RÉGLIETTE

PROFILÉ

## ALIMENTATIONS 24V

### Intérieures

|   |                              |    |              |              |
|---|------------------------------|----|--------------|--------------|
|    | P (w)                        | IP | Code         | € HT         |
|   | 7,2                          | 20 | <b>52003</b> | <b>22,30</b> |
|   | L x l x h = 118 x 40 x 10 mm |    |              |              |
|    | P (w)                        | IP | Code         | € HT         |
|   | 12                           | 20 | <b>0697</b>  | <b>25,10</b> |
|   | L x l x h = 84 x 40 x 22 mm  |    |              |              |
|    | P (w)                        | IP | Code         | € HT         |
|   | 15                           | 20 | <b>52007</b> | <b>26,50</b> |
|   | L x l x h = 121 x 45 x 16 mm |    |              |              |
|    | P (w)                        | IP | Code         | € HT         |
|   | 20                           | 20 | <b>52005</b> | <b>38,20</b> |
|   | L x l x h = 166 x 40 x 14 mm |    |              |              |
|    | P (w)                        | IP | Code         | € HT         |
|   | 30                           | 20 | <b>52012</b> | <b>52,00</b> |
|   | L x l x h = 246 x 30 x 16 mm |    |              |              |
|   | P (w)                        | IP | Code         | € HT         |
|   | 30                           | 20 | <b>0632</b>  | <b>37,70</b> |
|   | L x l x h = 165 x 40 x 30 mm |    |              |              |
|  | P (w)                        | IP | Code         | € HT         |
|   | 60                           | 20 | <b>0675</b>  | <b>70,40</b> |
|   | L x l x h = 188 x 45 x 30 mm |    |              |              |
|  | P (w)                        | IP | Code         | € HT         |
|   | 75                           | 20 | <b>52010</b> | <b>79,60</b> |
|   | L x l x h = 180 x 60 x 30 mm |    |              |              |

|  |                              |    |             |               |
|--|------------------------------|----|-------------|---------------|
|  | P (w)                        | IP | Code        | € HT          |
|  | 100                          | 20 | <b>0685</b> | <b>145,90</b> |
|  | L x l x h = 180 x 90 x 35 mm |    |             |               |
|  | P (w)                        | IP | Code        | € HT          |
|  | 180                          | 20 | <b>0732</b> | <b>215,20</b> |
|  | L x l x h = 280 x 64 x 31 mm |    |             |               |

### Extérieures

|  |                               |    |              |               |
|--|-------------------------------|----|--------------|---------------|
|    | P (w)                         | IP | Code         | € HT          |
|  | 30                            | 67 | <b>0695</b>  | <b>52,60</b>  |
|  | L x l x h = 160 x 50 x 40 mm  |    |              |               |
|    | P (w)                         | IP | Code         | € HT          |
|  | 60                            | 67 | <b>0032</b>  | <b>103,90</b> |
|  | L x l x h = 240 X 40 X 21 mm  |    |              |               |
|    | P (w)                         | IP | Code         | € HT          |
|  | 150                           | 66 | <b>0033</b>  | <b>217,50</b> |
|  | L x l x h = 252 x 68 x 39 mm  |    |              |               |
|   | P (w)                         | IP | Code         | € HT          |
|  | 320                           | 67 | <b>52013</b> | <b>357,00</b> |
|  | L x l x h = 252 x 90 x 44 mm  |    |              |               |
|  | P (w)                         | IP | Code         | € HT          |
|  | 600                           | 67 | <b>52016</b> | <b>663,00</b> |
|  | L x l x h = 280 x 144 x 49 mm |    |              |               |

## VARIATION LED 24V DC



Module variable PWM. Commande par bouton poussoir à distance. **Alimentation à commander séparément.**



| Référence | P (w) | Dim. (mm)<br>L x l x h | Code         | € HT          |
|-----------|-------|------------------------|--------------|---------------|
| MV100     | 100   | 100x48x28              | <b>50060</b> | <b>163,40</b> |

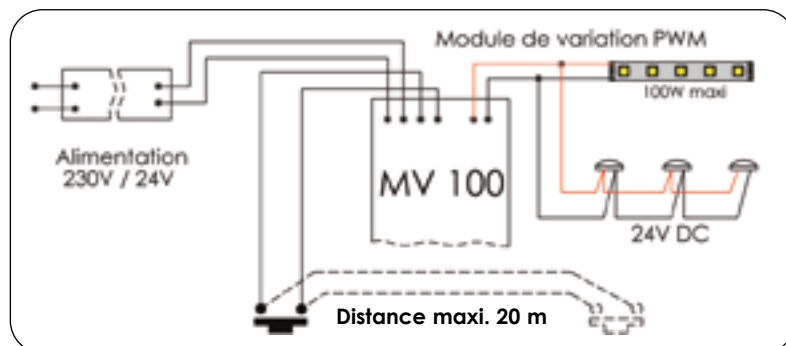



## ST 3



Alimentation 24V à commander séparément.

## Séquenceur

Permet de contrôler les différentes couleurs, blanc possible, la vitesse, la durée du changement de couleur, et la mémorisation des réglages (8 couleurs pré-enregistrées dont 1 blanc).

Permet de faire fonctionner 12 m de JAKLED 65 RGB ou FLEXO RGB.

Télécommande : HF 433 Hz - Distance maxi. : 20 m.

- 1 bouton marche/arrêt.
- 1 bouton pour le changement des programmes lumineux.
- 1 bouton pour le changement de vitesse des couleurs.

| P (w) | Tension | Code  | € HT  |
|-------|---------|-------|-------|
| 216*  | 24V DC  | 55007 | 62,20 |

\*3x 72W.

## Utilisation télécommande radio (distance maxi. : 40 m)

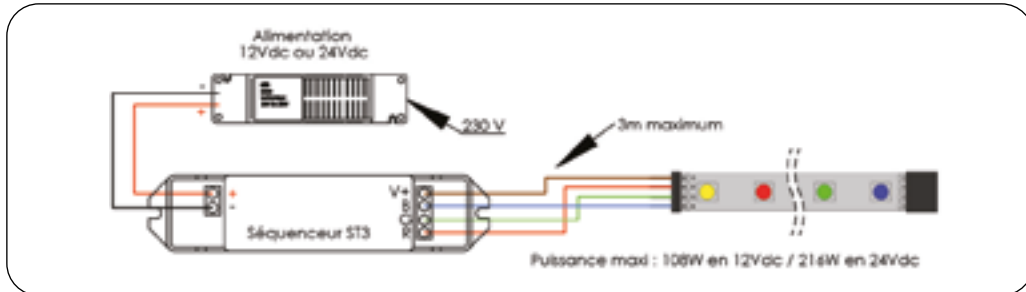
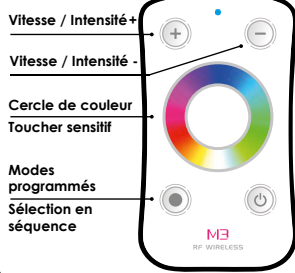

## STE 3



Alimentation 24V à commander séparément.

## Séquenceur - Esclave

Relais de puissance fonctionnant avec les mêmes réglages que le contrôleur Maître.

Possibilité de raccorder jusqu'à 20 esclaves (8 couleurs pré-enregistrées dont 1 blanc).

Permet de faire fonctionner 12 m de JAKLED 65 RGB ou FLEXO RGB.

| P (w) | Tension | Code  | € HT  |
|-------|---------|-------|-------|
| 216*  | 24V DC  | 55009 | 25,50 |

\*3x 72W.

## Utilisation télécommande radio (distance maxi. : 40 m)

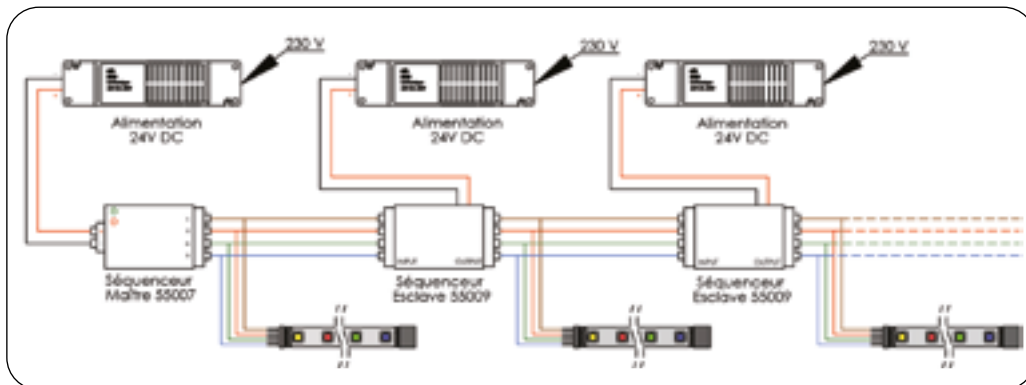
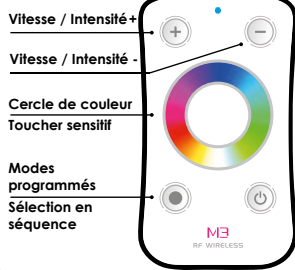

Câble pour réaliser les commandes d'un esclave à un autre esclave. Section 4x 0,5 mm<sup>2</sup> vendu au centimètre. Longueur minimale : 2 m.

| Code au centimètre | € HT |
|--------------------|------|
| 0599               | 0,10 |



JAKBEL

Sur-mesure



**Ruban silicone transparent, flexible, 28W/m, 95 lm/m.**

Précâblage usine, câble H05RN-F 2x 0,75 mm<sup>2</sup> 0,5 m, Compatible avec la variation.

| 28W/m    |             | 20 000 h   |                    |        |
|----------|-------------|------------|--------------------|--------|
| Teinte   | L (m) mini. | L (m) max. | Code au centimètre | € HT   |
| ● 2700 K | 0,4         | 25         | 1059               | 0,60 * |

\* Facturation minimum 1 mètre.

**Sur-mesure**

de 0,4 m 25 m  
(module 75 mm)



**ACCESSOIRES**

Câble d'alimentation sur-mesure en option.

| Désignation                                      | Code au centimètre | € HT |
|--|--------------------|------|
| Long. de câble IP65 supplémentaire au centimètre | 0946               | 0,04 |

Adhésif, peut être vissé.

| Désignation          | Code | € HT |
|----------------------|------|------|
| Clips fixation nylon | 0832 | 0,40 |



| Désignation                       | Code | € HT  |
|-----------------------------------|------|-------|
| Profilé polycarbonate 1 m         | 0945 | 0,10  |
| Set de réparation lampes claires* | 0940 | 33,30 |
| Tube colle silicone               | 0942 | 15,70 |

\* Lampes bleues ou vertes nous consulter.

LAMPE

DOWNLIGHT ENCASTRE

RAIL PROJECTEUR SPOTERIE

RÉGLETTTE

RUBAN

# SOMMAIRE | APPLIQUE - PLAFONNIER - SUSPENSION

## APPLIQUE - SALLE DE BAIN

BEMOL 1...p. 231



BEMOL 2...p. 231



TORA...p. 232



INOS...p. 232



TESSA...p. 233



## APPLIQUE DÉCORATIVE

TAYLOR...p. 234



PALACE...p. 235



ALTON...p. 236



GRANT...p. 237



GILDA...p. 238



PHOBOS...p. 239



BORA...p. 239



MOOREA...p. 240



HAWAI...p. 240



TAHITI...p. 241



ELASTO LED...p. 242



FIDJI...p. 243

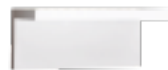

GLASSDISK...p. 243



VAGUE...p. 244



LAGON...p. 244



FLAMME LED...p. 245



TOSCA LED...p. 245



VIAX LED...p. 245



DOMINO S7-G...p. 246



DOMINO S2...p. 246



DOMINO S7-P...p. 247



DOMINO P12V...p. 247



DOMINO ANGLE 3...p. 247



DOMINO ANGLE 4...p. 247



DOMINO S6-E...p. 248



DOMINO S10...p. 248



DOMINO P11-V...p. 248



DOMINO S5...p. 249



DOMINO S6...p. 249



DOMINO S9...p. 249



DOMINO S5-E...p. 249



VIKI...p. 250



LARA...p. 250



STAFF...p. 251



DOMINO S7-P LED...p. 251



HILL...p. 252



BELLA...p. 252



MAGGIE...p. 253



AURA...p. 253



ZINK...p. 254



TAIS...p. 254



AMIRA...p. 255



DEDALO...p. 255



KUMA...p. 255



# SOMMAIRE | APPLIQUE - PLAFONNIER - SUSPENSION

## LISEUSE - APPLIQUE TABLEAU

LIZA .....p. 256



LIZEO .....p. 257



UGO .....p. 257



LIZA 2 .....p. 258



LIZA 3 .....p. 259



OPERA .....p. 260



TESSA .....p. 261



## ÉCLAIRAGE PANNEAU D'EXPO

JUDY EXPO .....p. 262



TIGE DE FIXATION .....p. 263



## PLAFONNIER

C4 SENSOR .....p. 264



C4 REMOTE .....p. 265



C4 .....p. 266



ADELA .....p. 267



GAIA .....p. 268



RHEA CCT .....p. 269



ORIA LED .....p. 270



PANDORA .....p. 271



GEA .....p. 272



ARMILLA .....p. 273



ALVA .....p. 273



DIGI 20 .....p. 274



DIGI 32 .....p. 274



TAHITI .....p. 275



## SUSPENSION

CURVES .....p. 276



MINI CURVES .....p. 277



JULIA .....p. 277



NOSTALGIE .....p. 278



ROMA .....p. 279



COMO .....p. 280



COOPER .....p. 281



EPOQUE .....p. 281



DIANA .....p. 282



ATON .....p. 284



NINA .....p. 285



STELA .....p. 286



SYRA .....p. 287



ASY LED .....p. 288



LINEAR .....p. 289



SORA .....p. 290



LEXA .....p. 291



## SUSPENSION SUR RAIL & TECHNIQUE

COMO .....p. 292



CURVES .....p. 293



LEXA .....p. 294



HIGH BAY .....p. 295



# VOLUMES DES SALLES D'EAU

Pour toute installation dans une salle d'eau, se conformer impérativement à la norme NFC 15-100 partie 7-701.

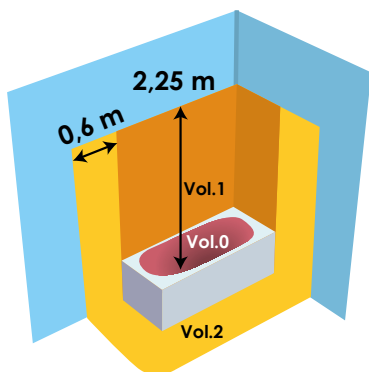

**Cas d'une salle d'eau avec baignoire**  
2,25 m mini au fond de la baignoire.

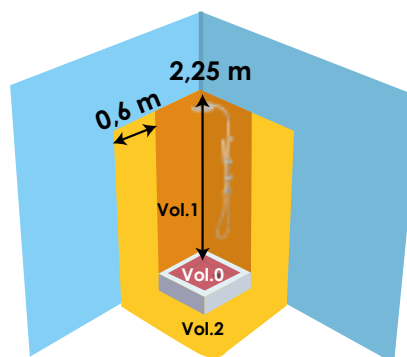

**Cas d'une salle d'eau avec receveur ou bac**  
2,25 m mini au fond du receveur.

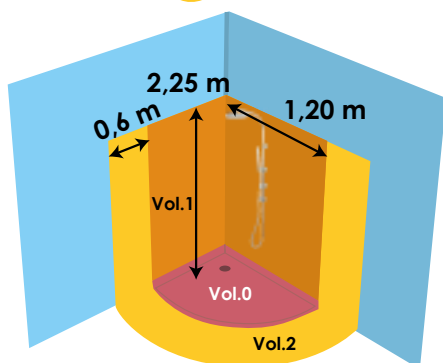

**Cas d'une douche à l'italienne**  
2,25 m mini du sol fini.

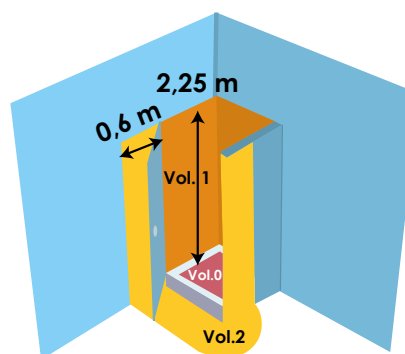

**Cas d'une douche avec paroi ou cloison et porte**  
2,25 m mini du fond du receveur ou sol fini.

## VOLUME 0

C'est le volume intérieur de la baignoire ou du receveur de douche. Pour les douches de plain-pied à l'italienne (sans receveur), il est délimité par le fond de la douche et le plan horizontal situé 10 cm au dessus du point le plus haut du fond de la douche et en partie latérale par les limites du volume 1.

**Sont autorisés les luminaires IPX7 de classe 3 alimentés en TBTS limitée à 12V en courant alternatif 30V en courant continu alimentés en T.B.TS.**

L'alimentation de sécurité doit être installée en dehors des volumes 0, 1 et 2.

## VOLUME 1

C'est le volume délimité en partie latérale :

- par les bords extérieurs de la baignoire ou du receveur de douche,
- pour les douches de plain-pied à l'italienne (sans receveur), par le cylindre vertical de rayon 1,20 m et dont l'axe passe par le centre de la tête de douche, par le point-raccord du flexible de douchette ou par l'ensemble des points constituant le périmètre extérieur de la douche pluie,
- pour les douches à jet horizontaux, les parois faisant obstacle aux jets.

Sa hauteur est limitée par le plus élevé des plans horizontaux suivants, soit au-dessus du volume 0 jusqu'à 2,25 m au dessus du sol fini ou du fond de la baignoire si celui-ci est au dessus du sol fini, soit au-dessus de la douche de tête.

Dans le cas de douche à têtes multiples, le volume 1 est délimité par l'ensemble des volumes individuels définis depuis chaque tête ou flexible

**Sont autorisés les luminaires de classe 3 alimentés en TBTS limitée à 12V courant alternatif ou 30V courant continu - IP X4 ou, IP X5 en présence de jets horizontaux pour raison de nettoyage, et les luminaires autorisés en volume 1.**

L'alimentation doit être installée en dehors des volumes 0, 1 et 2.

## VOLUME 2

C'est le volume situé à 0,6 m du bord du volume 1. La limite en hauteur est identique à celle du volume 1. La limite basse est celle du sol fini.

**Sont autorisés les luminaires de classe 2 - 230V et protégés par disjoncteur différentiel résiduel de 30 mA max - IP X4 ou, IP X5 en présence de jets horizontaux pour raison de nettoyage, et les luminaires autorisés en volume 1.**

L'alimentation doit être installée en dehors des volumes 0, 1 et 2.

## HORS VOLUMES

C'est le volume situé en dehors des volumes 0, 1, et 2.

## BEMOL 1



230V



Support bois et acier/Verre opale.

| 20W G9 |        | 2 000 h |                 |       |
|--------|--------|---------|-----------------|-------|
| Lumens | Teinte | Couleur | Code avec lampe | € HT  |
| 235    | 2700 K | blanc   | 0811            | 77,20 |
| 235    | 2700 K | wengé   | 0752            | 77,20 |
| 235    | 2700 K | teck    | 0753            | 77,20 |

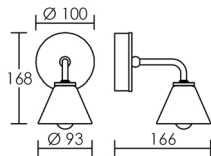

## BEMOL 2

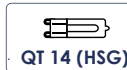

230V



Support bois et acier/Verre opale.

| 2x 20W G9 |        | 2 000 h |                 |        |
|-----------|--------|---------|-----------------|--------|
| Lumens    | Teinte | Couleur | Code avec lampe | € HT   |
| 470       | 2700 K | blanc   | 0817            | 143,40 |
| 470       | 2700 K | wengé   | 0770            | 143,40 |
| 470       | 2700 K | teck    | 0771            | 143,40 |

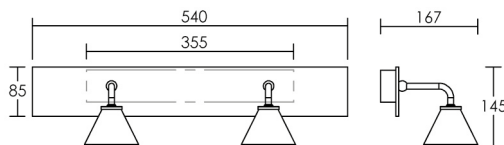

TORA



Corps acier/Verre satiné. Pince pour accroche sur vitre miroir et embase pour fixation sur champ de meuble.

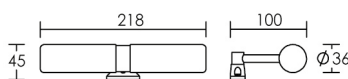

**2x 28W G9** **2 000 h**

| Lumens | Teinte   | Couleur | Code avec lampe | € HT         |
|--------|----------|---------|-----------------|--------------|
| 480    | ● 2700 K | chrome  | <b>3941</b>     | <b>48,00</b> |

INOS



240 lm



Corps acier/Verre satiné.

**3,8W G9** **20 000 h**

| Lumens | Teinte   | Couleur | Code avec lampe | € HT         |
|--------|----------|---------|-----------------|--------------|
| 240    | ● 3000 K | chrome  | <b>4714</b>     | <b>66,40</b> |

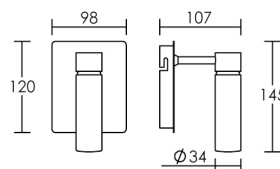



TESSA



500 lm



Corps aluminium/Diffuseur polycarbonate. Finition chromé. Accessoires de fixation inclus. 3 poses possibles : murale sur patère, sur champ de meuble, ou sur miroir.

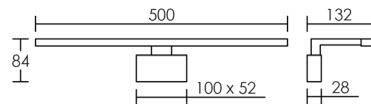

|                 |        |         |              |              |
|-----------------|--------|---------|--------------|--------------|
| <b>30 000 h</b> |        |         |              |              |
| P (W)           | Lumens | Teinte  | Code         | € HT         |
| 5,5             | 500    | ○4000 K | <b>53052</b> | <b>77,50</b> |

POSSIBILITÉS D'INSTALLATION



Fixation sur miroir



Fixation sur champs de meuble



Fixation patère murale



LAMPE

DOWNLIGHT ENCASTRE

RAIL PROJECTEUR SPOTERIE

RÉGLLETTE

RUBAN PROFILÉ

APPLIQUE

TAYLOR



1300 lm

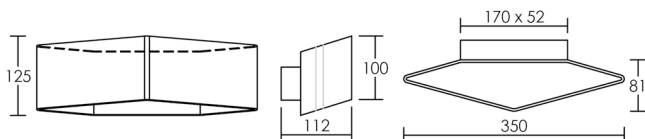

Corps en aluminium. Eclairage indirect. **Alimentation 500 mA intégrée.**

| 2x 10W |          |           |              | 50 000 h      |
|--------|----------|-----------|--------------|---------------|
| Lumens | Teinte   | Couleur   | Code         | € HT          |
| 1300   | ● 3000 K | blanc     | <b>50548</b> | <b>151,00</b> |
| 1300   | ● 3000 K | aluminium | <b>50549</b> | <b>165,20</b> |
| 1300   | ● 3000 K | noir/or   | <b>50560</b> | <b>165,20</b> |

Dimmable par coupe de phase.

## PALACE



1100 lm



Corps en aluminium. Eclairage indirect. **Alimentation 500 mA intégrée.**

**2x 9W** **30 000 h**

| Lumens | Teinte | Couleur   | Code         | € HT          |
|--------|--------|-----------|--------------|---------------|
| 1100   | 3000 K | blanc     | <b>50545</b> | <b>171,40</b> |
| 1100   | 3000 K | aluminium | <b>50546</b> | <b>188,70</b> |
| 1100   | 3000 K | noir/or   | <b>50547</b> | <b>188,70</b> |

Dimmable par coupure de phase.

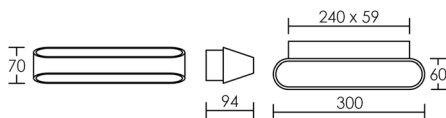

LAMPE

DOWNLIGHT  
ENCASTRERAIL  
PROJECTEUR  
SPOTERIE

RÉGLLETTE

RUBAN  
PROFILÉ

APPLIQUE

ALTON



700 lm

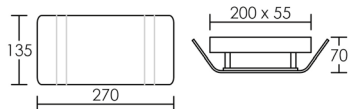

Face avant en aluminium (codes **50550** et **50551**) ou en bois (codes **50552** et **50553**)/Base en aluminium blanc. Eclairage indirect. **Alimentation 700 mA intégrée.**

| 15W    |          |            |              | 30 000 h      |
|--------|----------|------------|--------------|---------------|
| Lumens | Teinte   | Couleur    | Code         | € HT          |
| 700    | ● 3000 K | blanc      | <b>50550</b> | <b>143,80</b> |
| 700    | ● 3000 K | aluminium  | <b>50551</b> | <b>143,80</b> |
| 700    | ● 3000 K | bois foncé | <b>50552</b> | <b>153,00</b> |
| 700    | ● 3000 K | bois clair | <b>50553</b> | <b>153,00</b> |

Dimmable par coupure de phase.

## GRANT



700 lm



Face avant en aluminium (codes **50554** et **50555**) ou en bois (codes **50556** et **50557**)/Base en aluminium blanc.  
Éclairage indirect. **Alimentation 700 mA intégrée.**

| 15W    |          | 30 000 h   |              |               |
|--------|----------|------------|--------------|---------------|
| Lumens | Teinte   | Couleur    | Code         | € HT          |
| 700    | ● 3000 K | blanc      | <b>50554</b> | <b>143,80</b> |
| 700    | ● 3000 K | aluminium  | <b>50555</b> | <b>143,80</b> |
| 700    | ● 3000 K | bois foncé | <b>50556</b> | <b>151,00</b> |
| 700    | ● 3000 K | bois clair | <b>50557</b> | <b>151,00</b> |

Dimmable par coupure de phase.

LAMPE

DOWNLIGHT  
ENCASTRERAIL  
PROJECTEUR  
SPOTERIE

RÉGLLETTE

RUBAN  
PROFILÉ

APPLIQUE

GILDA



5400 lm

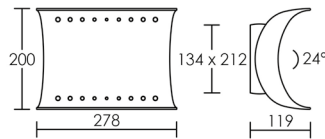

Corps aluminium blanc. Eclairage indirect.  
Alimentation intégrée.

|       |        |        |       |          |
|-------|--------|--------|-------|----------|
| 15W   |        |        |       | 50 000 h |
| P (w) | Lumens | Teinte | Code  | € HT     |
| 51    | 5400   | 3000 K | 50048 | 462,10   |

|       |        |                       |       |
|-------|--------|-----------------------|-------|
| 50048 | 3000 K | 51 W                  | 115°  |
|       | h (m)  | E <sub>max</sub> (lx) | d (m) |
|       | 3      | 122                   | 12,6  |
|       | 2      | 489                   | 6,3   |
|       | 1      | 1954                  | 3,1   |



# PHOBOS



3000 lm

Corps aluminium blanc/Verre de protection/Patère acier blanc. Orientable. **Alimentation intégrée.**

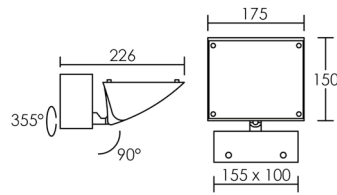

◀ 80° 25 000 h

| P (w) | Lumens | Teinte   | Code         | € HT          |
|-------|--------|----------|--------------|---------------|
| 40    | 3000   | ○ 4000 K | <b>50232</b> | <b>237,70</b> |

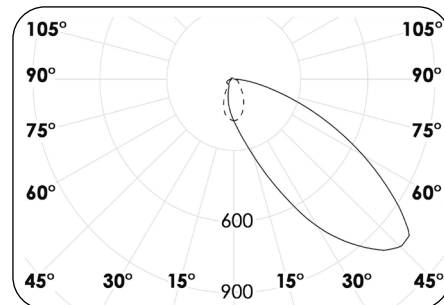

CD/klm  
C0 - C180 --- C90 - C270 η = 100%

# BORA



300 lm

Corps aluminium blanc. Eclairage direct/indirect. **Alimentation intégrée.**

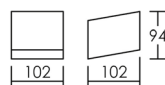

30 000 h

| P (w) | Lumens | Teinte   | Code         | € HT          |
|-------|--------|----------|--------------|---------------|
| 6     | 300    | ● 3000 K | <b>50162</b> | <b>102,00</b> |

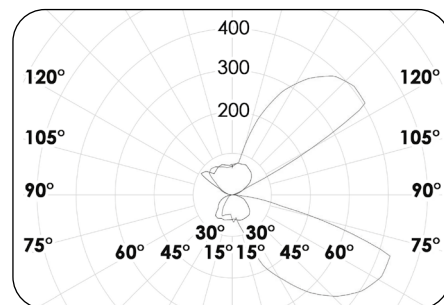

CD/klm  
C0 - C180 --- C90 - C270 η = 100%

## MOOREA



600 lm

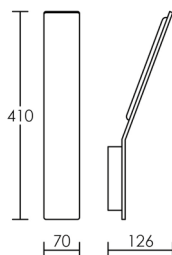

Corps aluminium blanc. Eclairage indirect.  
**Alimentation intégrée.**

30 000 h

| P (w) | Lumens | Teinte   | Code         | € HT          |
|-------|--------|----------|--------------|---------------|
| 8     | 600    | ● 3000 K | <b>50164</b> | <b>140,80</b> |

## HAWAI



500 lm

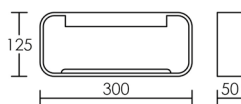

Corps aluminium blanc. Eclairage direct/indirect.  
**Alimentation intégrée.**

30 000 h

| P (w) | Lumens | Teinte   | Code         | € HT          |
|-------|--------|----------|--------------|---------------|
| 8     | 500    | ● 3000 K | <b>50161</b> | <b>152,00</b> |



TAHITI



Jusqu'à  
**1100 lm**

Corps aluminium. Orientable. Alimentation intégrée.

Version 13W - Noir



◁ 36° **50 000 h**

| P (w)       | Lumens | Teinte | Code         | € HT          |
|-------------|--------|--------|--------------|---------------|
| <b>N</b> 13 | 1100   | 3000 K | <b>50840</b> | <b>136,70</b> |

Dimmable par coupure de fin de phase.

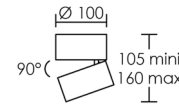

| 50840 | 3000K                 | 13W   | 36° |
|-------|-----------------------|-------|-----|
| h (m) | E <sub>max</sub> (lx) | d (m) |     |
| 1     | <b>2272</b>           | 0,65  |     |
| 2     | <b>568</b>            | 1,3   |     |
| 3     | <b>252</b>            | 1,9   |     |

Version 10W - Blanc



◁ 33° **30 000 h**

| P (w) | Lumens | Teinte | Code         | € HT          |
|-------|--------|--------|--------------|---------------|
| 10    | 710    | 3000 K | <b>50160</b> | <b>136,70</b> |

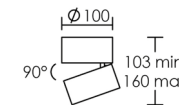

| 50160 | 3000K                 | 10W   | 33° |
|-------|-----------------------|-------|-----|
| h (m) | E <sub>max</sub> (lx) | d (m) |     |
| 1     | <b>1354</b>           | 0,59  |     |
| 2     | <b>339</b>            | 1,2   |     |
| 3     | <b>217</b>            | 1,5   |     |

Version MINI - Blanc



◁ 44° **30 000 h**

| P (w) | Lumens | Teinte | Code         | € HT         |
|-------|--------|--------|--------------|--------------|
| 8     | 620    | 3000 K | <b>50320</b> | <b>93,80</b> |

Dimmable par coupure de phase.

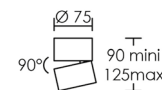

| 50320 | 3000K                 | 8W    | 44° |
|-------|-----------------------|-------|-----|
| h (m) | E <sub>max</sub> (lx) | d (m) |     |
| 1     | <b>1100</b>           | 0,81  |     |
| 2     | <b>275</b>            | 1,6   |     |
| 3     | <b>122</b>            | 2,4   |     |

LAMPE

DOWNLIGHT  
ENCASTRE

RAIL  
PROJECTEUR  
SPOTIERIE

RÉGLLETTE

RUBAN  
PROFILÉ

APPLIQUE

**ELASTO LED**

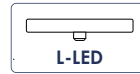

**640 lm**

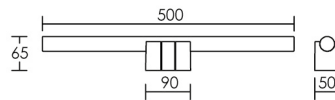
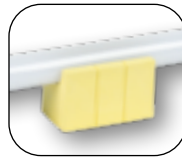
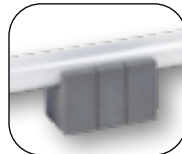

Applique décorative, corps élastomère souple.

**8W S14d 35 000 h**

| Lumens | Teinte | Couleur | Code avec lampe | € HT         |
|--------|--------|---------|-----------------|--------------|
| 640    | 2700 K | blanc   | <b>54016</b>    | <b>56,10</b> |
| 640    | 2700 K | gris    | <b>54017</b>    | <b>56,10</b> |
| 640    | 2700 K | jaune   | <b>54018</b>    | <b>56,10</b> |



**Lampe vendue avec ces appareils (p. 34) :**

**S14d - CULOT CENTRAL LED 8W**



**640 lm**

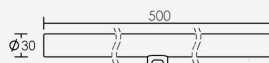

Lampe culot central S14d opale. Culot isolé : 22 x 29 x 14 mm. Remplace les lampes incandescentes.

| P (W) | Dim. Ø x L (mm) | Lumens | Teinte | Code         | € HT         |
|-------|-----------------|--------|--------|--------------|--------------|
| 8     | 30 x 500        | 640    | 2700 K | <b>54011</b> | <b>41,80</b> |

FIDJI



480 lm

Corps aluminium blanc. Eclairage indirect.  
**Alimentation intégrée.**

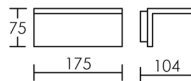

| ◁ 100° |        | 30 000 h |              |               |
|--------|--------|----------|--------------|---------------|
| P (w)  | Lumens | Teinte   | Code         | € HT          |
| 8      | 480    | ● 3000 K | <b>50163</b> | <b>140,80</b> |

GLASSDISK



1590 lm

Corps aluminium blanc/Disque verre sablé. Eclairage indirect. **Alimentation intégrée.**



| ◁ 120° |        | 30 000 h |              |               |
|--------|--------|----------|--------------|---------------|
| P (w)  | Lumens | Teinte   | Code         | € HT          |
| 17     | 1590   | ● 3000 K | <b>50558</b> | <b>152,00</b> |
| 17     | 1590   | ○ 4000 K | <b>50115</b> | <b>152,00</b> |

Dimmable par coupure de fin de phase.

| 50558 | 3000 K                | 17 W  | 120° |
|-------|-----------------------|-------|------|
| h (m) | E <sub>max</sub> (lx) | d (m) |      |
| 3     | <b>36</b>             | 13,9  |      |
| 2     | <b>144</b>            | 6,9   |      |
| 1     | <b>575</b>            | 3,5   |      |

| 50115 | 4000 K                | 17 W  | 120° |
|-------|-----------------------|-------|------|
| h (m) | E <sub>max</sub> (lx) | d (m) |      |
| 3     | <b>36</b>             | 13,9  |      |
| 2     | <b>144</b>            | 6,9   |      |
| 1     | <b>575</b>            | 3,5   |      |

## VAGUE



IRC  
>90



230V

IP  
20



800 lm

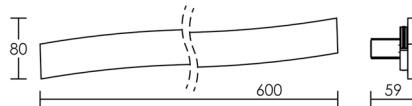

Face avant en plâtre/Support aluminium.  
LED SMD « 3528 ». **Alimentation intégrée.**

|   |       |        |          |              | 30 000 h      |
|---|-------|--------|----------|--------------|---------------|
|   | P (w) | Lumens | Teinte   | Code         | € HT          |
| N | 12    | 770    | ● 3000 K | <b>50841</b> | <b>157,00</b> |
|   | 12    | 800    | ○ 4200 K | <b>50275</b> | <b>157,00</b> |

## LAGON



IRC  
>90



230V

IP  
20



240 lm

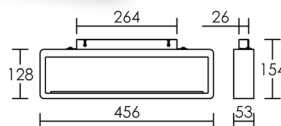

Face avant en plâtre/Support aluminium.  
LED SMD « 3528 ». **Alimentation intégrée.**

|   |       |        |          |              | 30 000 h      |
|---|-------|--------|----------|--------------|---------------|
|   | P (w) | Lumens | Teinte   | Code         | € HT          |
| N | 7     | 230    | ● 3000 K | <b>50842</b> | <b>144,00</b> |
|   | 7     | 240    | ○ 4200 K | <b>50276</b> | <b>144,00</b> |

## FLAMME LED



220 lm

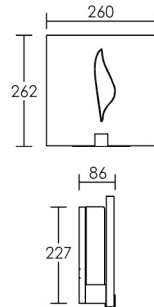

Face avant en plâtre/Support aluminium anodisé.  
**Alimentation intégrée.**

30 000 h

| P (w) | Lumens | Teinte | Code | € HT   |
|-------|--------|--------|------|--------|
| 3,6   | 220    | 3000 K | 3025 | 174,00 |
| 3,6   | 220    | 6300 K | 3023 | 174,00 |

Face plâtre recharge, code 0114.

## TOSCA LED



220 lm

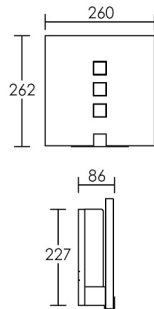

Face avant en plâtre/Support aluminium anodisé.  
**Alimentation intégrée.**

30 000 h

| P (w) | Lumens | Teinte | Code | € HT   |
|-------|--------|--------|------|--------|
| 3,6   | 220    | 3000 K | 3027 | 174,00 |
| 3,6   | 220    | 6300 K | 3054 | 174,00 |

Face plâtre recharge, code 0113.

## VIAX LED



220 lm

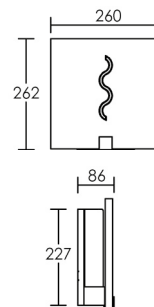

Face avant en plâtre/Support aluminium anodisé.  
**Alimentation intégrée.**

30 000 h

| P (w) | Lumens | Teinte | Code | € HT   |
|-------|--------|--------|------|--------|
| 3,6   | 220    | 3000 K | 3051 | 174,00 |
| 3,6   | 220    | 6300 K | 3053 | 174,00 |

Face plâtre recharge, code 0112.

LAMPE

DOWNLIGHT  
ENCASTRE

RAIL  
PROJECTEUR  
SPOTERIE

RÉGLLETTE

RUBAN  
PROFILÉ

APPLIQUE

# DOMINO

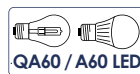

Corps plâtre. Eclairage indirect.

## Version S7-G



| P (w) | Douille | Couleur | Code sans lampe | € HT   |
|-------|---------|---------|-----------------|--------|
| 77    | E27     | blanc   | 3002            | 103,40 |

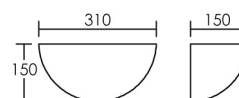

## Version S2



| P (w) | Douille | Couleur | Code sans lampe | € HT   |
|-------|---------|---------|-----------------|--------|
| 77    | E27     | blanc   | 3029            | 127,60 |



## Version S7-P

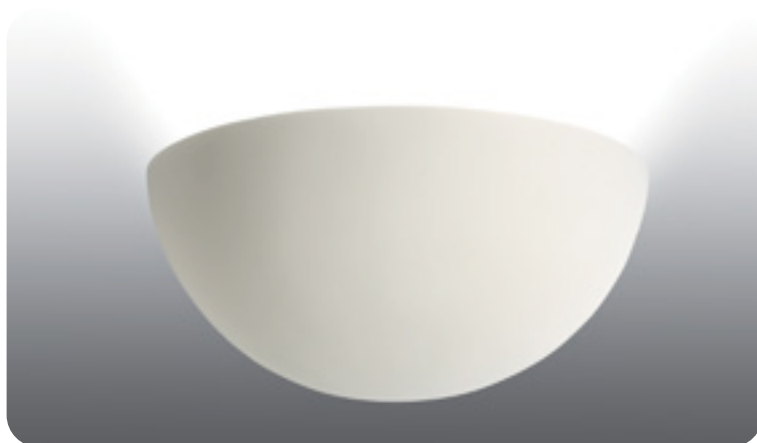

| P (w) | Douille | Couleur | Code | € HT  |
|-------|---------|---------|------|-------|
| 77    | E27     | blanc   | 3000 | 89,10 |



Version P12-V



Corps plâtre/Verre dépoli.

| P (w) | Douille | Couleur | Code sans lampe | € HT   |
|-------|---------|---------|-----------------|--------|
| 77    | E27     | blanc   | 3009            | 202,90 |

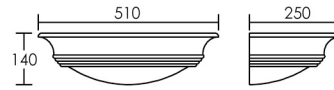

Version Angle 3



| P (w) | Douille | Couleur | Code sans lampe | € HT   |
|-------|---------|---------|-----------------|--------|
| 77    | E27     | blanc   | 3011            | 110,70 |

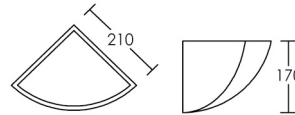

Version Angle 4



| P (w) | Douille | Couleur | Code sans lampe | € HT   |
|-------|---------|---------|-----------------|--------|
| 77    | E27     | blanc   | 3010            | 110,70 |

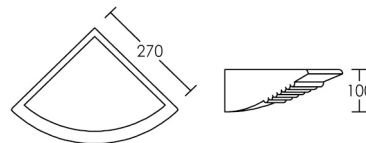

**DOMINO**

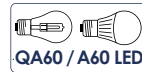

Corps plâtre. Eclairage indirect.

**Version S6-E**



| P (w) | Douille | Couleur | Code sans lampe | € HT   |
|-------|---------|---------|-----------------|--------|
| 77    | E27     | blanc   | 3005            | 113,80 |

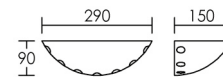

**Version S10**



| P (w) | Douille | Couleur | Code sans lampe | € HT   |
|-------|---------|---------|-----------------|--------|
| 77    | E27     | blanc   | 3006            | 184,40 |

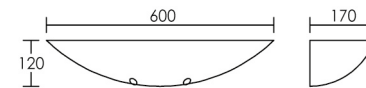

**Version P11-V**



Corps plâtre/Verre dépoli.

| P (w) | Douille | Couleur | Code sans lampe | € HT   |
|-------|---------|---------|-----------------|--------|
| 77    | E27     | blanc   | 3008            | 199,80 |





Version S5

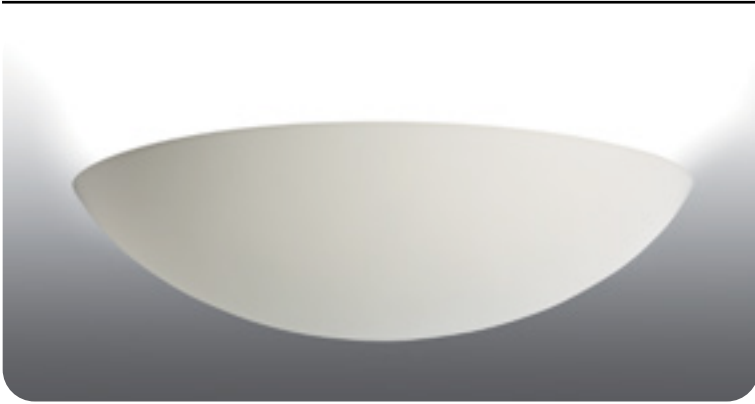

| P (w) | Douille | Couleur | Code sans lampe | € HT   |
|-------|---------|---------|-----------------|--------|
| 77    | E27     | blanc   | 3001            | 106,40 |

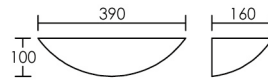

Version S6

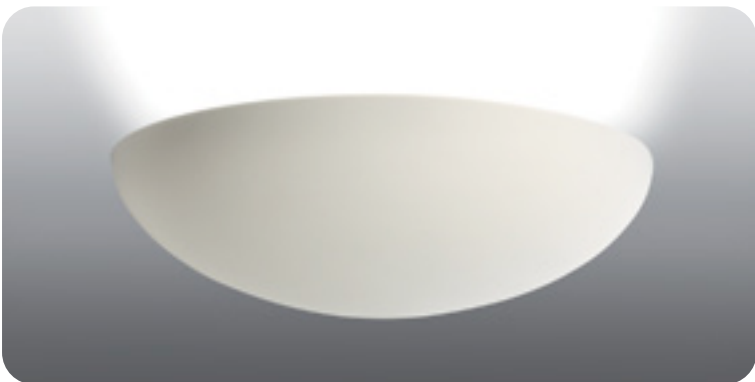

| P (w) | Douille | Couleur | Code sans lampe | € HT   |
|-------|---------|---------|-----------------|--------|
| 77    | E27     | blanc   | 3004            | 103,00 |

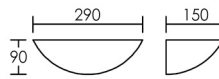

Version S9

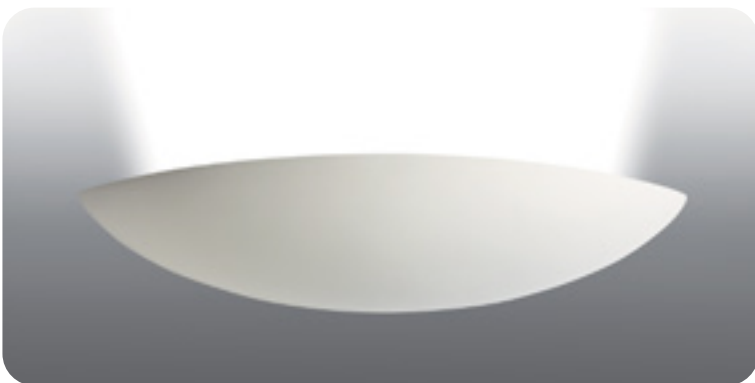

| P (w) | Douille | Couleur | Code sans lampe | € HT   |
|-------|---------|---------|-----------------|--------|
| 77    | E27     | blanc   | 3007            | 173,70 |

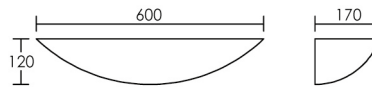

Version S5-E



| P (w) | Douille | Couleur | Code sans lampe | € HT   |
|-------|---------|---------|-----------------|--------|
| 77    | E27     | blanc   | 3003            | 116,70 |



LAMPE

DOWNLIGHT  
ENCASTRE

RAIL  
PROJECTEUR  
SPOTERIE

RÉGLLETTE

RUBAN  
PROFILÉ

APPLIQUE

VIKI

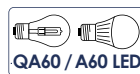

Corps plâtre. Eclairage indirect.

| P (w) | Douille | Couleur | Code sans lampe | € HT   |
|-------|---------|---------|-----------------|--------|
| 77    | E27     | blanc   | 3022            | 130,70 |

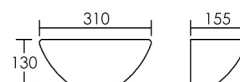

LARA

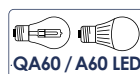

Corps plâtre/Verre dépoli. Eclairage indirect.

| P (w) | Douille | Couleur | Code sans lampe | € HT   |
|-------|---------|---------|-----------------|--------|
| 77    | E27     | blanc   | 3021            | 184,40 |



ISO 9001  
BUREAU VERITAS  
Certification



Les appliques plâtre

Réalisation dans nos ateliers d'Aubervilliers, en région parisienne.



STAFF



2200 lm

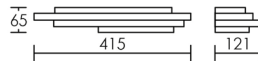

Corps plâtre. Eclairage indirect. Alimentation intégrée.

| 30 000 h |        |        |       |        |
|----------|--------|--------|-------|--------|
| P (w)    | Lumens | Teinte | Code  | € HT   |
| 20       | 2200   | 3000 K | 50819 | 154,00 |

Dimmable par coupure de phase.

DOMINO S7-P LED



1590 lm



Corps plâtre. Eclairage indirect. Alimentation intégrée.

| 30 000 h |        |        |       |        |
|----------|--------|--------|-------|--------|
| P (w)    | Lumens | Teinte | Code  | € HT   |
| 17       | 1590   | 3000 K | 50544 | 119,30 |
| 17       | 1590   | 4000 K | 3056  | 119,30 |

Dimmable par coupure de fin de phase.



| 50544 | 3000 K                | 17 W  | 120° |
|-------|-----------------------|-------|------|
| h (m) | E <sub>max</sub> (lx) | d (m) |      |
| 3     | 36                    | 13,9  |      |
| 2     | 144                   | 6,9   |      |
| 1     | 575                   | 3,5   |      |

| 3056  | 4000 K                | 17 W  | 120° |
|-------|-----------------------|-------|------|
| h (m) | E <sub>max</sub> (lx) | d (m) |      |
| 3     | 36                    | 13,9  |      |
| 2     | 144                   | 6,9   |      |
| 1     | 575                   | 3,5   |      |

LAMPE

DOWNLIGHT ENCASTRE

RAIL PROJECTEUR SPOTIERIE

RÉGLIETTE

RUBAN PROFILÉ

APPLIQUE

## HILL

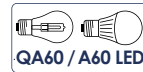

Support acier blanc. Double verre opale décoratif.

### Version demi-lune



| P (w) | Douille | Verre | Code sans lampe | € HT  |
|-------|---------|-------|-----------------|-------|
| 60    | E27     | opale | 3978            | 54,50 |

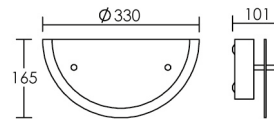

### Version ronde



| P (w) | Douille | Verre | Code sans lampe | € HT  |
|-------|---------|-------|-----------------|-------|
| 60    | E27     | opale | 3979            | 75,00 |

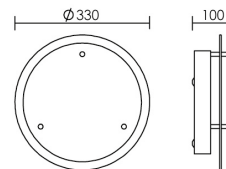

## BELLA

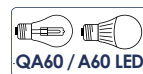

Support acier/Enjoliveur bois/Verre opale.



| P (w) | Douille | Couleur  | Code sans lampe | € HT  |
|-------|---------|----------|-----------------|-------|
| 60    | E27     | merisier | 1820            | 63,50 |

Verre de rechange, code 1051.

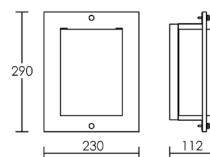

MAGGIE



Support acier blanc. Double verre opale décoratif.

Version rectangulaire



| P (w) | Douille | Verre | Code sans lampe | € HT         |
|-------|---------|-------|-----------------|--------------|
| 60    | E27     | opale | <b>3977</b>     | <b>62,50</b> |

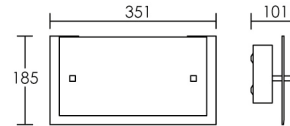

Version carrée



| P (w) | Douille | Verre | Code sans lampe | € HT         |
|-------|---------|-------|-----------------|--------------|
| 60    | E27     | opale | <b>3976</b>     | <b>87,50</b> |

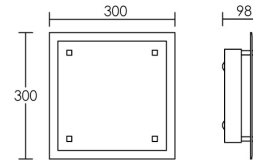

AURA



Support acier et bois/Verre opale.



| P (w) | Douille | Couleur  | Code sans lampe | € HT         |
|-------|---------|----------|-----------------|--------------|
| 60    | E27     | ébène    | <b>3973</b>     | <b>46,60</b> |
| 60    | E27     | merisier | <b>1821</b>     | <b>47,20</b> |

Verre de rechange, code **1052**.

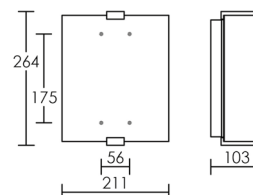

## ZINK 1



Support acier nickel/Verre satiné.

**33W G9** **2 000 h**

| Lumens | Teinte   | Verre  | Code avec lampe | € HT         |
|--------|----------|--------|-----------------|--------------|
| 285    | ● 2900 K | satiné | <b>1387</b>     | <b>44,90</b> |

Verre de rechange, code **4167**.

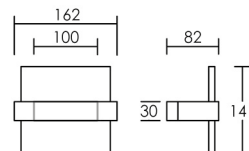

## ZINK 2



Support acier nickel/Verre satiné.

**120W R7s 118 mm** **3 000 h**

| Lumens | Teinte   | Verre  | Code avec lampe | € HT         |
|--------|----------|--------|-----------------|--------------|
| 1170   | ● 2900 K | satiné | <b>1388</b>     | <b>70,90</b> |

Verre de rechange, code **4168**.

Verre tubulaire, code **4169**.

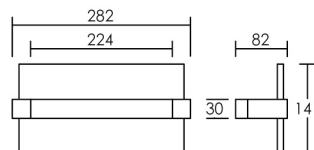

## TAIS



Support acier brossé/Verre satiné.

**120W R7s 118 mm** **2 000 h**

| Lumens | Teinte   | Verre  | Code avec lampe | € HT         |
|--------|----------|--------|-----------------|--------------|
| 1350   | ● 2900 K | satiné | <b>1345</b>     | <b>54,40</b> |

Verre de rechange, code **4166**.

Verre tubulaire, code **4169**.

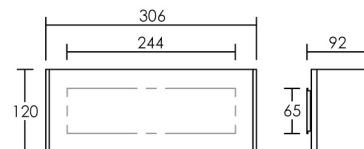

## AMIRA

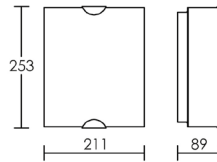

Support acier/Verre opale.

| P (w) | Douille | Verre | Code sans lampe | € HT  |
|-------|---------|-------|-----------------|-------|
| 60    | E27     | opale | 3974            | 43,20 |

Verre de rechange, code 1052.



LED p. 20

## DEDALO

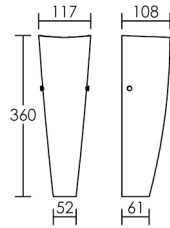

Support acier/Verre opale.

| P (w) | Douille | Verre | Code sans lampe | € HT  |
|-------|---------|-------|-----------------|-------|
| 75    | E27     | opale | 1800            | 99,00 |



LED p. 20

## KUMA

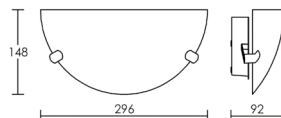

Support acier/Verre opale.

| P (w) | Douille | Verre | Code sans lampe | € HT  |
|-------|---------|-------|-----------------|-------|
| 60    | E27     | opale | 3972            | 30,70 |

Verre de rechange, code 0122.



LED p. 20

## LIZA



110 lm

Support acier/Tête aluminium. Interrupteur. Alimentation 350 mA intégrée.

## Version 01 - Patère



1,2W &lt;math&gt;\sphericalangle 40^\circ&lt;/math&gt; 30 000 h

| Lumens | Teinte | Couleur | Code | € HT  |
|--------|--------|---------|------|-------|
| 110    | 3000 K | gris    | 5222 | 77,50 |

| LIZA 1-2 3000 K | 1,2 W          | 40°   |
|-----------------|----------------|-------|
| h (m)           | $E_{max}$ (lx) | d (m) |
| 0,5             | 956            | 0,36  |
| 1               | 239            | 0,73  |
| 2               | 60             | 1,5   |

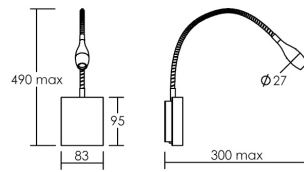

## Version ET3 - Encastré

Boîte d'encastrement spécifique Ø65 mm fournie.



1,2W &lt;math&gt;\sphericalangle 40^\circ&lt;/math&gt; 30 000 h

| Lumens | Teinte | Couleur | Code | € HT  |
|--------|--------|---------|------|-------|
| 110    | 3000 K | gris    | 5223 | 73,40 |

| LIZA 1-2 3000 K | 1,2 W          | 40°   |
|-----------------|----------------|-------|
| h (m)           | $E_{max}$ (lx) | d (m) |
| 0,5             | 956            | 0,36  |
| 1               | 239            | 0,73  |
| 2               | 60             | 1,5   |

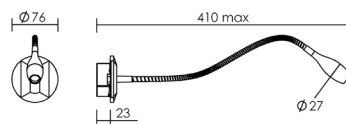



## LIZEO



140 lm



Corps métal et acrylique. **Alimentation intégrée.**  
Double éclairage : ambiance (200 lm) et liseuse orientable (voir tableau). Le port USB intégré permet la charge (5V - 1A).

| 9W     |        | 40 000 h |              |               |
|--------|--------|----------|--------------|---------------|
| Lumens | Teinte | Couleur  | Code         | € HT          |
| N 140  | 3000 K | blanc    | <b>50868</b> | <b>127,00</b> |
| N 140  | 3000 K | noir     | <b>50869</b> | <b>127,00</b> |

| LIZEO | 3000K                 | 3W    | 30° |
|-------|-----------------------|-------|-----|
| h (m) | E <sub>max</sub> (lx) | d (m) |     |
| 0,5   | <b>1272</b>           | 0,27  |     |
| 1     | <b>318</b>            | 0,5   |     |
| 2     | <b>80</b>             | 1,1   |     |

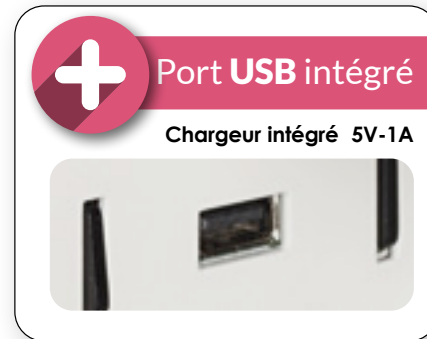

## UGO



Patère acier/Corps aluminium. Interrupteur.

| 33W G9 |        | 2 000 h |                 |              |
|--------|--------|---------|-----------------|--------------|
| Lumens | Teinte | Couleur | Code avec lampe | € HT         |
| 460    | 2900 K | opale   | <b>1845</b>     | <b>39,20</b> |

Verre de rechange, code **1098**.

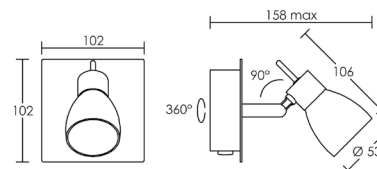

## LIZA 2



110 lm

Support acier/Tête aluminium. Interrupteur. Alimentation 350 mA intégrée.

## Version 01 - Patère

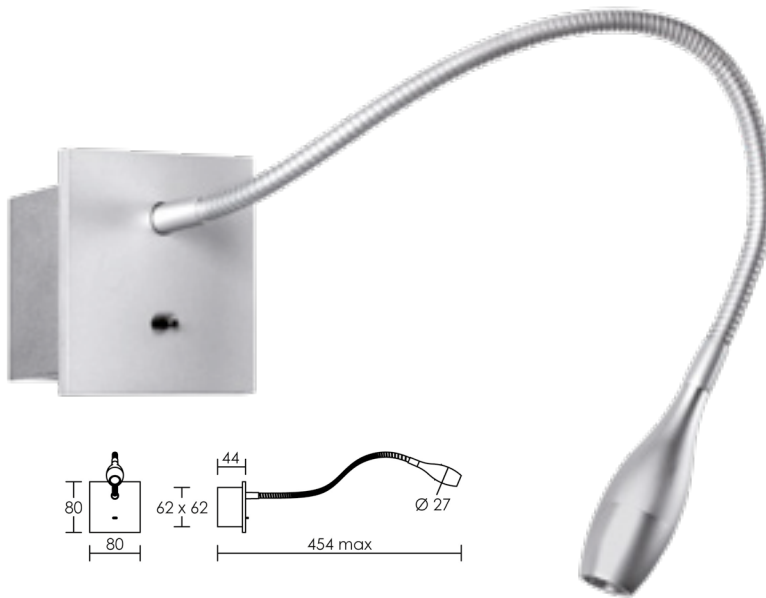

1,2W &lt;math&gt;\sphericalangle 40^\circ&lt;/math&gt; 30 000 h

| Lumens | Teinte | Couleur   | Code  | € HT   |
|--------|--------|-----------|-------|--------|
| 110    | 3000 K | gris alu. | 50255 | 114,20 |
| 110    | 3000 K | chromé    | 50256 | 123,40 |

| LIZA 1-2 | 3000 K         | 1,2 W | 40° |
|----------|----------------|-------|-----|
| h (m)    | $E_{max}$ (lx) | d (m) |     |
| 0,5      | 956            | 0,36  |     |
| 1        | 239            | 0,73  |     |
| 2        | 60             | 1,5   |     |

## Version ET3 - Encastré

Livré sans boîte d'encastrement.



1,2W &lt;math&gt;\sphericalangle 40^\circ&lt;/math&gt; 30 000 h

| Lumens | Teinte | Couleur   | Code  | € HT   |
|--------|--------|-----------|-------|--------|
| 110    | 3000 K | gris alu. | 50251 | 119,30 |
| 110    | 3000 K | chromé    | 50252 | 128,50 |

| LIZA 1-2 | 3000 K         | 1,2 W | 40° |
|----------|----------------|-------|-----|
| h (m)    | $E_{max}$ (lx) | d (m) |     |
| 0,5      | 956            | 0,36  |     |
| 1        | 239            | 0,73  |     |
| 2        | 60             | 1,5   |     |



## LIZA 3



145 lm

Support acier/Tête aluminium. Interrupteur et variateur incorporé. Alimentation 500 mA intégrée.

## Version 01 - Patère

1,6W  $\angle 40^\circ$  30 000 h

| Lumens | Teinte | Couleur   | Code  | € HT   |
|--------|--------|-----------|-------|--------|
| 145    | 3000 K | gris alu. | 50257 | 147,90 |
| 145    | 3000 K | chromé    | 50258 | 160,10 |

Dimmable par pression sur interrupteur.

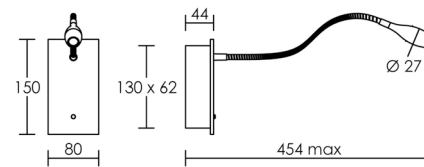

| LIZA 3 | 3000 K | 1,6 W                 | 40°   |
|--------|--------|-----------------------|-------|
|        | h (m)  | E <sub>max</sub> (lx) | d (m) |
|        | 0,5    | 1264                  | 0,36  |
|        | 1      | 316                   | 0,73  |
|        | 2      | 79                    | 1,5   |

## Version ET3 - Encastré

Livré sans boîte d'encastrement.

1,6W  $\angle 40^\circ$  30 000 h

| Lumens | Teinte | Couleur   | Code  | € HT   |
|--------|--------|-----------|-------|--------|
| 145    | 3000 K | gris alu. | 50253 | 145,90 |
| 145    | 3000 K | chromé    | 50254 | 158,10 |

Dimmable par pression sur interrupteur.

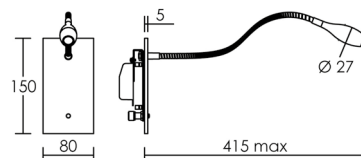

| LIZA 3 | 3000 K | 1,6 W                 | 40°   |
|--------|--------|-----------------------|-------|
|        | h (m)  | E <sub>max</sub> (lx) | d (m) |
|        | 0,5    | 1264                  | 0,36  |
|        | 1      | 316                   | 0,73  |
|        | 2      | 79                    | 1,5   |



## OPERA



Corps acier/Patère rectangulaire. Tête orientable à 90°.

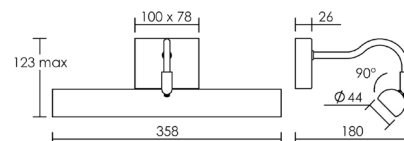

## Version LED



450 lm



Circuit LED 2835. Alimentation intégrée dans la patère.

**6W** **30 000 h**

| Lumens | Teinte | Couleur  | Code | € HT   |
|--------|--------|----------|------|--------|
| 450    | 3000 K | laitonné | 0368 | 141,80 |

## Version G9



**2x 20W G9** **2 000 h**

| Lumens | Teinte | Couleur  | Code avec lampe | € HT  |
|--------|--------|----------|-----------------|-------|
| 360    | 2700 K | laitonné | 0329            | 83,90 |

TESSA



500 lm



Corps aluminium/Diffuseur polycarbonate. Finition chromé. Accessoires de fixation inclus. 3 poses possibles : murale sur patère, sur champ de meuble, ou sur miroir.

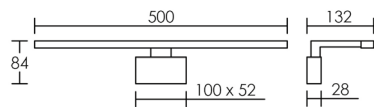

30 000 h

| P (w) | Lumens | Teinte   | Code         | € HT         |
|-------|--------|----------|--------------|--------------|
| 5,5   | 500    | ○ 4000 K | <b>53052</b> | <b>77,50</b> |



LAMPE

DOWNLIGHT  
ENCASTRE

RAIL  
PROJECTEUR  
SPOTERIE

RÉGLLETTE

RUBAN  
PROFILÉ

APPLIQUE

JUDY EXPO - LED DIMMABLE 5,5



410 lm



Corps polycarbonate. Lampes LED dimmables fournies.

5,5W ◁36° GU10 15 000 h

|          | Lumens | Teinte | Couleur | Code avec lampe | € HT         |
|----------|--------|--------|---------|-----------------|--------------|
| <b>N</b> | 410    | 3000 K | blanc   | <b>4389</b>     | <b>76,00</b> |
| <b>N</b> | 410    | 3000 K | noir    | <b>4390</b>     | <b>76,00</b> |

Dimmable par coupure de fin de phase.

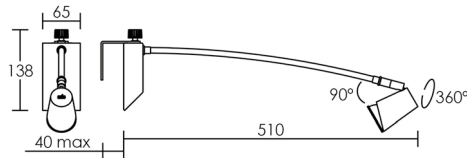

| GLASS | 3000K | 5,5 W                 | 36°   |
|-------|-------|-----------------------|-------|
|       | h (m) | E <sub>max</sub> (lx) | d (m) |
| ▲     | 1     | 692                   | 0,65  |
| ▲     | 2     | 173                   | 1,3   |
| ▲     | 2,5   | 111                   | 1,6   |



**TIGE DE FIXATION pour panneau expo**

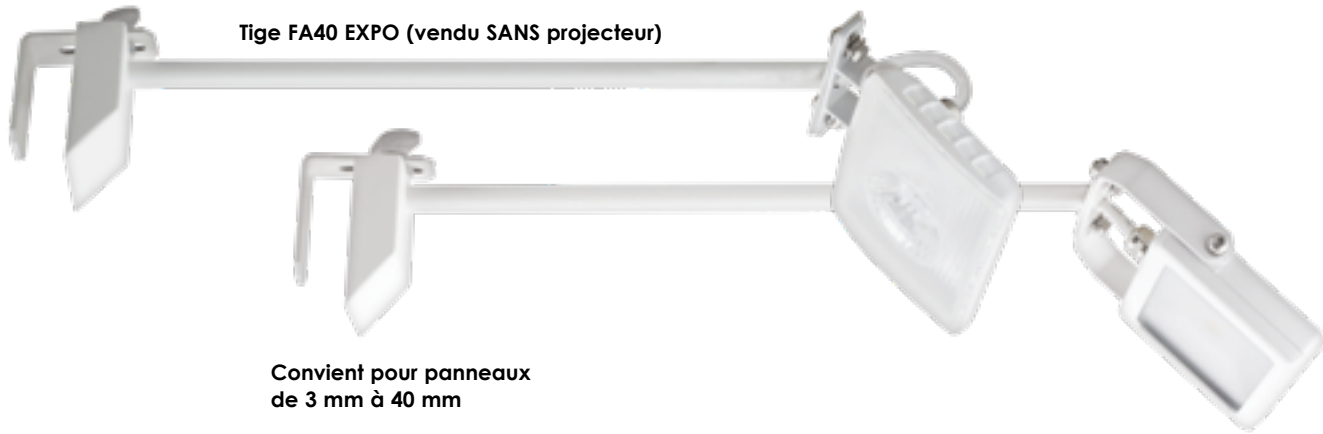

Convient pour panneaux de 3 mm à 40 mm

Support et tige acier. Convient pour les projecteurs WINK 10/20/30W et ELFI.



| Couleur | Code         | € HT         |
|---------|--------------|--------------|
| blanc   | <b>50451</b> | <b>27,30</b> |
| noir    | <b>50594</b> | <b>27,30</b> |

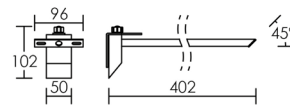

**Appareils adaptés à ces tiges :**

**ELFI**



ELFI (p. 314)

**WINK 10W / 20W / 30W**



Gamme WINK (p. 312)

Exemple :

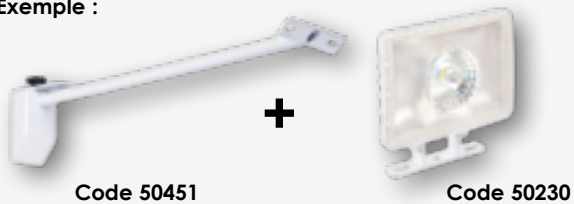

Exemple :



## C4 SENSOR



Corps en métal/Vasque en PMMA opale/Anneau en ABS. Anneau décoratif amovible.



### Version 16W - Ø300 mm

1250 lm

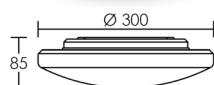

Version 16W sans anneau

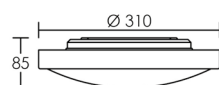

Version 16W avec anneau

16W 25 000 h

| Lumens | Teinte  | Anneau    | Code         | € HT         |
|--------|---------|-----------|--------------|--------------|
| 1250*  | ○4000 K | blanc     | <b>50510</b> | <b>56,10</b> |
| 1250*  | ○4000 K | aluminium | <b>50512</b> | <b>61,20</b> |
| 1250*  | ○4000 K | chromé    | <b>50514</b> | <b>66,30</b> |

\* 1150 lm avec l'anneau décoratif.

| C4/S  | 4000 K         | 16W   | 110° |
|-------|----------------|-------|------|
| h (m) | $E_{max}$ (lx) | d (m) |      |
| 1     | <b>349</b>     | 2,86  |      |
| 2     | <b>87</b>      | 5,7   |      |
| 3     | <b>39</b>      | 8,6   |      |

### Version 21W - Ø400 mm

1600 lm

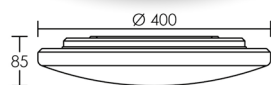

Version 21W sans anneau

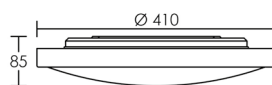

Version 21W avec anneau

21W 25 000 h

| Lumens | Teinte  | Anneau    | Code         | € HT         |
|--------|---------|-----------|--------------|--------------|
| 1600*  | ○4000 K | blanc     | <b>50511</b> | <b>70,40</b> |
| 1600*  | ○4000 K | aluminium | <b>50513</b> | <b>76,50</b> |
| 1600*  | ○4000 K | chromé    | <b>50515</b> | <b>85,70</b> |

\* 1500 lm avec l'anneau décoratif.

| C4/S  | 4000 K         | 21W   | 110° |
|-------|----------------|-------|------|
| h (m) | $E_{max}$ (lx) | d (m) |      |
| 1     | <b>454</b>     | 2,86  |      |
| 2     | <b>113</b>     | 5,7   |      |
| 3     | <b>50</b>      | 8,6   |      |

## PRINCIPE DE FONCTIONNEMENT SENSOR

- ✓ Possibilité de régler la sensibilité de la détection, de 10 à 100%
- ✓ Possibilité de régler la durée d'éclairage, de 5 s à 15 min
- ✓ Possibilité d'activer la détection crépusculaire à 50 lux

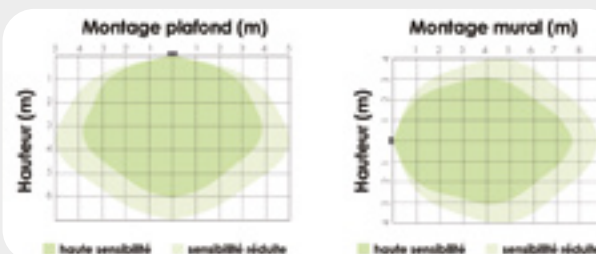



C4 REMOTE



Corps en métal/Vasque en PMMA opale/Anneau en ABS. Anneau décoratif amovible.



Version 16W - Ø300 mm

1250 lm

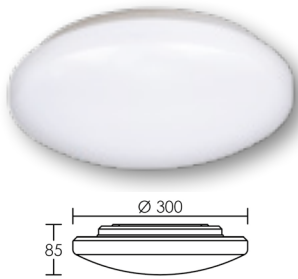

Version 16W sans anneau

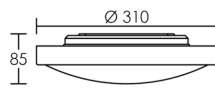

Version 16W avec anneau

16W 25 000 h

| Lumens | Teinte     | Anneau    | Code         | € HT         |
|--------|------------|-----------|--------------|--------------|
| 1250*  | ● 2700 K   | blanc     | <b>50520</b> | <b>59,20</b> |
| 1250*  | ○ à 6000 K | aluminium | <b>50522</b> | <b>63,20</b> |
| 1250*  | ○ 6000 K   | chromé    | <b>50524</b> | <b>68,30</b> |

\* Lumens indiqués pour 4000 K.  
1150 lm avec l'anneau décoratif.

| C4/R  | 4000 K                | 16W   | 110° |
|-------|-----------------------|-------|------|
| h (m) | E <sub>max</sub> (lx) | d (m) |      |
| 1     | 340                   | 2,86  |      |
| 2     | 85                    | 5,7   |      |
| 3     | 38                    | 8,6   |      |

Version 21W - Ø400 mm

1600 lm

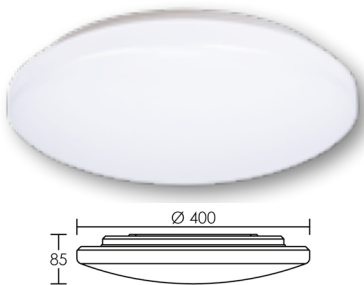

Version 21W sans anneau

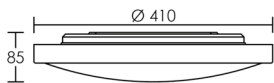

Version 21W avec anneau

21W 25 000 h

| Lumens | Teinte     | Anneau    | Code         | € HT         |
|--------|------------|-----------|--------------|--------------|
| 1600*  | ● 2700 K   | blanc     | <b>50521</b> | <b>72,40</b> |
| 1600*  | ○ à 6000 K | aluminium | <b>50523</b> | <b>78,50</b> |
| 1600*  | ○ 6000 K   | chromé    | <b>50525</b> | <b>87,70</b> |

\* Lumens indiqués pour 4000 K.  
1500 lm avec l'anneau décoratif.

| C4/R  | 4000 K                | 21W   | 110° |
|-------|-----------------------|-------|------|
| h (m) | E <sub>max</sub> (lx) | d (m) |      |
| 1     | 444                   | 2,86  |      |
| 2     | 111                   | 5,7   |      |
| 3     | 49                    | 8,6   |      |

PRINCIPE DE FONCTIONNEMENT REMOTE

- ✓ Possibilité de régler l'intensité lumineuse, de 10% à 100% sur 10 paliers
- ✓ Possibilité de régler la température de couleur, de 2700 K à 6000 K sur 8 paliers
- ✓ Fonction veille
- ✓ Fonction mémoire
- ✓ Timer 10 min / 30 min



Fonction veilleuse



Variation teinte



Variation 10 à 100%

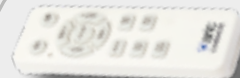

C4



Corps en métal/Vasque en PMMA opale/Anneau en ABS. Anneau décoratif amovible.



Version 10W - Ø250 mm

800 lm

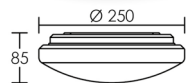

Version 10W sans anneau

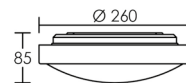

Version 10W avec anneau

| 10W    |         |           |              |              | 25 000 h |
|--------|---------|-----------|--------------|--------------|----------|
| Lumens | Teinte  | Anneau    | Code         | € HT         |          |
| 800 *  | ○4000 K | blanc     | <b>50429</b> | <b>47,90</b> |          |
| 800 *  | ○4000 K | aluminium | <b>50435</b> | <b>55,10</b> |          |
| 800 *  | ○4000 K | chromé    | <b>50436</b> | <b>63,20</b> |          |

\* 700 lm avec l'anneau décoratif.

| C4    | 4000K                 | 10 W  | 120° |
|-------|-----------------------|-------|------|
| h (m) | E <sub>max</sub> (lx) | d (m) |      |
| 1     | <b>204</b>            | 3,46  |      |
| 2     | <b>51</b>             | 6,9   |      |
| 3     | <b>23</b>             | 10,4  |      |

Version 21W - Ø350 mm

1600 lm

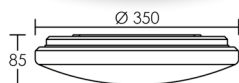

Version 21W sans anneau

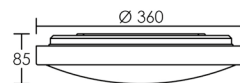

Version 21W avec anneau

| 21W    |         |           |              |              | 25 000 h |
|--------|---------|-----------|--------------|--------------|----------|
| Lumens | Teinte  | Anneau    | Code         | € HT         |          |
| 1600*  | ○4000 K | blanc     | <b>50430</b> | <b>70,20</b> |          |
| 1600*  | ○4000 K | aluminium | <b>50437</b> | <b>74,50</b> |          |
| 1600*  | ○4000 K | chromé    | <b>50438</b> | <b>83,60</b> |          |

\* 1500 lm avec l'anneau décoratif.

| C4    | 4000K                 | 21 W  | 120° |
|-------|-----------------------|-------|------|
| h (m) | E <sub>max</sub> (lx) | d (m) |      |
| 1     | <b>452</b>            | 3,46  |      |
| 2     | <b>113</b>            | 6,9   |      |
| 3     | <b>50</b>             | 10,4  |      |

ADELA



1000 lm

Corps thermoplastique blanc/Diffuseur polycarbonate blanc.

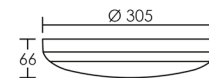

Version SENSOR

Détecteur de passage intégré. Mode crépusculaire.



| ◁ 110° |        | 25 000 h |       |       |
|--------|--------|----------|-------|-------|
| P (w)  | Lumens | Teinte   | Code  | € HT  |
| 14     | 1000   | ○ 4000 K | 50732 | 50,00 |

| 50732 | 4000K                 | 13 W  | 110° |
|-------|-----------------------|-------|------|
| h (m) | E <sub>max</sub> (lx) | d (m) |      |
| 1     | 331                   | 2,86  |      |
| 2     | 83                    | 5,7   |      |
| 3     | 37                    | 8,6   |      |

Version standard

| ◁ 110° |        | 25 000 h |       |       |
|--------|--------|----------|-------|-------|
| P (w)  | Lumens | Teinte   | Code  | € HT  |
| 13     | 1000   | ○ 4000 K | 50731 | 28,60 |

| 50731 | 4000K                 | 13 W  | 110° |
|-------|-----------------------|-------|------|
| h (m) | E <sub>max</sub> (lx) | d (m) |      |
| 1     | 331                   | 2,86  |      |
| 2     | 83                    | 5,7   |      |
| 3     | 37                    | 8,6   |      |

PRINCIPE DE FONCTIONNEMENT SENSOR

- ✓ Possibilité de régler la sensibilité de la détection, de 10 à 100%
- ✓ Possibilité de régler la durée d'éclairage, de 5 s à 15 min
- ✓ Possibilité de régler la détection crépusculaire sur 3 niveaux : 300 lux - 75 lux - 20 lux.

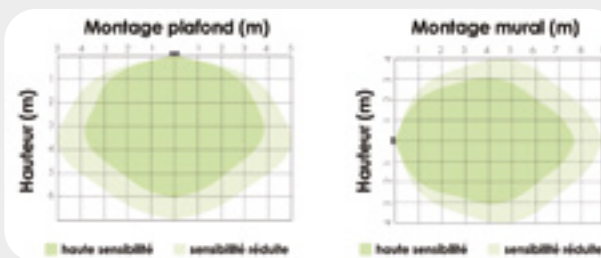

GAIA



1500 lm

Corps thermoplastique blanc/Diffuseur polycarbonate blanc.

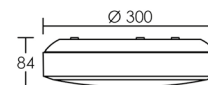

Version SENSOR



Détecteur de passage intégré.

| ◁ 110° |        |          |              | 30 000 h     |
|--------|--------|----------|--------------|--------------|
| P (w)  | Lumens | Teinte   | Code         | € HT         |
| 15,5   | 1500   | ○ 4000 K | <b>50730</b> | <b>70,40</b> |

| 50730 | 4000K                 | 15,5W | 110° |
|-------|-----------------------|-------|------|
| h (m) | E <sub>max</sub> (lx) | d (m) |      |
| 1     | <b>545</b>            | 2,86  |      |
| 2     | <b>136</b>            | 5,7   |      |
| 3     | <b>61</b>             | 8,6   |      |

Version standard

| ◁ 110° |        |          |              | 30 000 h     |
|--------|--------|----------|--------------|--------------|
| P (w)  | Lumens | Teinte   | Code         | € HT         |
| 14,5   | 1500   | ○ 4000 K | <b>50729</b> | <b>54,10</b> |

| 50729 | 4000K                 | 14,5W | 110° |
|-------|-----------------------|-------|------|
| h (m) | E <sub>max</sub> (lx) | d (m) |      |
| 1     | <b>545</b>            | 2,86  |      |
| 2     | <b>136</b>            | 5,7   |      |
| 3     | <b>61</b>             | 8,6   |      |

PRINCIPE DE FONCTIONNEMENT SENSOR

- ✓ Possibilité de régler la sensibilité de la détection, de 10 à 100%
- ✓ Possibilité de régler la durée d'éclairage, de 5 s à 15 min

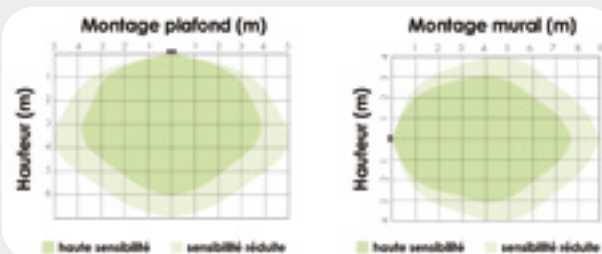

RHEA CCT



2300 lm

Corps et diffuseur polycarbonate blanc/Diffuseur opale.

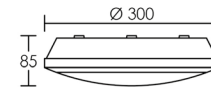

Version SENSOR

Détecteur de passage intégré. Mode crépusculaire.

| ○ 3000 K / ○ 4000 K |        | 35 000 h |              |              |
|---------------------|--------|----------|--------------|--------------|
| P (w)               | Lumens | Couleur  | Code         | € HT         |
| <b>N</b> 21         | 2300   | blanc    | <b>50909</b> | <b>78,00</b> |

Données de la LED en 4000 K.

| 50909 @ 4000K | 21W                   | 110°  |
|---------------|-----------------------|-------|
| h (m)         | E <sub>max</sub> (lx) | d (m) |
| 1             | <b>717</b>            | 2,86  |
| 2             | <b>179</b>            | 5,7   |
| 3             | <b>80</b>             | 8,6   |

Version standard

| ○ 3000 K / ○ 4000 K |        | 35 000 h |              |              |
|---------------------|--------|----------|--------------|--------------|
| P (w)               | Lumens | Couleur  | Code         | € HT         |
| <b>N</b> 10         | 1150   | blanc    | <b>50907</b> | <b>54,00</b> |
| <b>N</b> 21         | 2200   | blanc    | <b>50908</b> | <b>58,00</b> |

Données de la LED en 4000 K.

| 50907 @ 4000K | 10W                   | 110°  |
|---------------|-----------------------|-------|
| h (m)         | E <sub>max</sub> (lx) | d (m) |
| 1             | <b>380</b>            | 2,86  |
| 2             | <b>95</b>             | 5,7   |
| 3             | <b>42</b>             | 8,6   |

| 50908 @ 4000K | 21W                   | 110°  |
|---------------|-----------------------|-------|
| h (m)         | E <sub>max</sub> (lx) | d (m) |
| 1             | <b>725</b>            | 2,86  |
| 2             | <b>181</b>            | 5,7   |
| 3             | <b>81</b>             | 8,6   |

ACCESSOIRES



Collerettes 1/4 de tour.

| Désignation       | Code         | € HT        |
|-------------------|--------------|-------------|
| Demi-lune blanche | <b>50910</b> | <b>6,80</b> |
| Demi-lune noire   | <b>50911</b> | <b>6,80</b> |
| Collerette noire  | <b>50912</b> | <b>3,50</b> |

LAMPE

DOWNLIGHT ENCASTRE

RAIL PROJECTEUR SPOTERIE

RÉGLIETTE

RUBAN PROFILÉ

PLAFONNIER

ORIA



Jusqu'à  
**950 lm**

Corps et diffuseur polycarbonate blanc/Diffuseur cristal transparent.

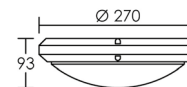

Version LED DIMMABLE



| 50319 | 4000 K                | 10 W  | 125° |
|-------|-----------------------|-------|------|
| h (m) | E <sub>max</sub> (lx) | d (m) |      |
| 1     | 262                   | 3,84  |      |
| 1,5   | 116                   | 5,8   |      |
| 2     | 66                    | 7,7   |      |

| 35 000 h |        |          |       |       |
|----------|--------|----------|-------|-------|
| P (w)    | Lumens | Teinte   | Code  | € HT  |
| 10       | 950    | ○ 4000 K | 50319 | 84,70 |

Dimmable par coupure de phase.

Version LED NON DIMMABLE



| 50321 | 4000 K                | 10 W  | 120° |
|-------|-----------------------|-------|------|
| h (m) | E <sub>max</sub> (lx) | d (m) |      |
| 1     | 176                   | 3,46  |      |
| 2     | 44                    | 6,9   |      |
| 2,5   | 28                    | 8,7   |      |

| 35 000 h |        |          |       |       |
|----------|--------|----------|-------|-------|
| P (w)    | Lumens | Teinte   | Code  | € HT  |
| 10       | 650    | ○ 4000 K | 50321 | 47,90 |

Version sans lampe



| P (w) | Douille | Couleur | Code sans lampe | € HT  |
|-------|---------|---------|-----------------|-------|
| 60    | E27     | blanc   | 3649            | 25,50 |



PANDORA

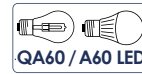

Support acier blanc/Verre opale. **Se démonte sans outil, fixation par 1/4 de tour.**



Version IP20

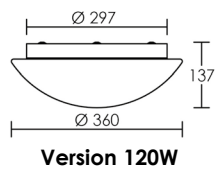
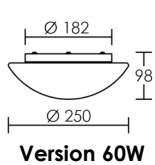

| P (w) | Douille | Couleur | Code sans lampe | € HT  |
|-------|---------|---------|-----------------|-------|
| 60    | E27     | blanc   | 1315            | 53,50 |
| 2x 60 | E27     | blanc   | 1316            | 90,10 |

Verre de rechange Ø250 mm, code 1348.

Version IP44

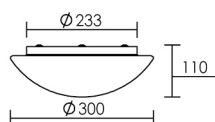

| P (w) | Douille | Couleur | Code sans lampe | € HT  |
|-------|---------|---------|-----------------|-------|
| 60    | E27     | blanc   | 1319            | 84,50 |





1800 lm

Corps et diffuseur polycarbonate blanc/Diffuseur opale.

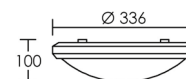

Version LED DIMMABLE



|       |        |                       |       |
|-------|--------|-----------------------|-------|
| 50309 | 4000 K | 20 W                  | 120°  |
|       | h (m)  | E <sub>max</sub> (lx) | d (m) |
|       | 1      | 525                   | 3,46  |
|       | 2      | 131                   | 6,9   |
|       | 3      | 58                    | 10,4  |

|          |        |          |       |        |
|----------|--------|----------|-------|--------|
| 50 000 h |        |          |       |        |
| P (w)    | Lumens | Teinte   | Code  | € HT   |
| 20       | 1800   | ○ 4000 K | 50309 | 130,60 |

Dimmable par coupure de phase.

Version sans lampe

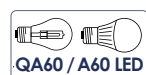

|       |         |         |                 |       |
|-------|---------|---------|-----------------|-------|
| P (w) | Douille | Couleur | Code sans lampe | € HT  |
| 60    | E27     | blanc   | 3647            | 37,10 |



LED p. 20



# ARMILLA

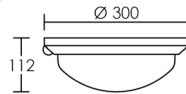
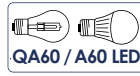

Support et diffuseur polycarbonate blanc. **Détecteur de mouvement infrarouge.** Utilisation intérieure et extérieure.

| P (w) | Douille | Couleur | Code sans lampe | € HT         |
|-------|---------|---------|-----------------|--------------|
| 60    | E27     | blanc   | <b>4004</b>     | <b>96,50</b> |

Détail de la détection p. 422.

## DÉTECTION ARMILLA

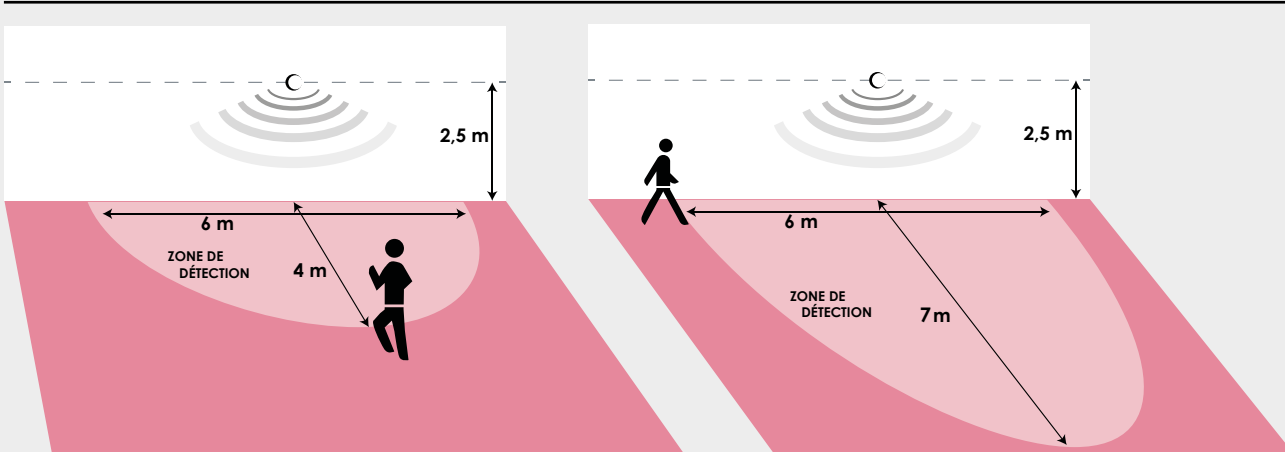

# ALVA

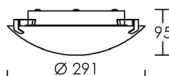
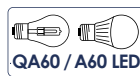

Version 60W



Version 120W



Support acier/Verre opale.

| P (w) | Douille | Verre | Code sans lampe | € HT         |
|-------|---------|-------|-----------------|--------------|
| 60    | E27     | opale | <b>3970</b>     | <b>42,10</b> |
| 2x 60 | E27     | opale | <b>3971</b>     | <b>83,00</b> |

Verre de rechange Ø291 mm, code **0120**.  
Verre de rechange Ø450 mm, code **0121**.

## DIGI 20



1700 lm

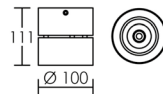

Corps aluminium blanc/Réflecteur aluminium à facettes avec protection plastique transparente.  
**Alimentation intégrée.**

◁ 50° 25 000 h

| P (w) | Lumens | Teinte   | Code         | € HT          |
|-------|--------|----------|--------------|---------------|
| 20    | 1700   | ● 3000 K | <b>50225</b> | <b>161,20</b> |

| 50225                             | 3000K       | 20W  | 50° |
|-----------------------------------|-------------|------|-----|
| h (m) E <sub>max</sub> (lx) d (m) |             |      |     |
| 1                                 | <b>2347</b> | 0,93 |     |
| 2                                 | <b>587</b>  | 1,9  |     |
| 3                                 | <b>261</b>  | 2,8  |     |

## DIGI 32



3600 lm

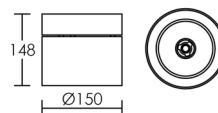

Corps aluminium blanc/Réflecteur aluminium à facettes avec protection plastique transparente.  
**Alimentation intégrée.**

◁ 70° 25 000 h

| P (w) | Lumens | Teinte   | Code         | € HT          |
|-------|--------|----------|--------------|---------------|
| 34    | 3600   | ○ 4000 K | <b>50224</b> | <b>236,60</b> |

| 50224                             | 4000 K      | 34 W | 70° |
|-----------------------------------|-------------|------|-----|
| h (m) E <sub>max</sub> (lx) d (m) |             |      |     |
| 1                                 | <b>2823</b> | 1,4  |     |
| 2                                 | <b>706</b>  | 2,8  |     |
| 2,5                               | <b>452</b>  | 3,5  |     |

TAHITI



Jusqu'à  
**1100 lm**

Corps aluminium. Orientable. Alimentation intégrée.

Version 13W - Noir



◁ 36° **50 000 h**

| P (w)       | Lumens | Teinte | Code         | € HT          |
|-------------|--------|--------|--------------|---------------|
| <b>N</b> 13 | 1100   | 3000 K | <b>50840</b> | <b>136,70</b> |

Dimmable par coupure de fin de phase.

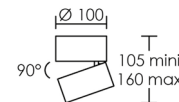

| 50840 | 3000K                 | 13W   | 36° |
|-------|-----------------------|-------|-----|
| h (m) | E <sub>max</sub> (lx) | d (m) |     |
| 1     | <b>2272</b>           | 0,65  |     |
| 2     | <b>568</b>            | 1,3   |     |
| 3     | <b>252</b>            | 1,9   |     |

Version 10W - Blanc



◁ 33° **30 000 h**

| P (w) | Lumens | Teinte | Code         | € HT          |
|-------|--------|--------|--------------|---------------|
| 10    | 710    | 3000 K | <b>50160</b> | <b>136,70</b> |

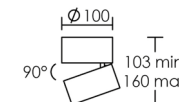

| 50160 | 3000K                 | 10W   | 33° |
|-------|-----------------------|-------|-----|
| h (m) | E <sub>max</sub> (lx) | d (m) |     |
| 1     | <b>1354</b>           | 0,59  |     |
| 2     | <b>339</b>            | 1,2   |     |
| 3     | <b>217</b>            | 1,5   |     |

Version MINI - Blanc



◁ 44° **30 000 h**

| P (w) | Lumens | Teinte | Code         | € HT         |
|-------|--------|--------|--------------|--------------|
| 8     | 620    | 3000 K | <b>50320</b> | <b>93,80</b> |

Dimmable par coupure de phase.

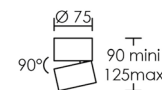

| 50320 | 3000K                 | 8W    | 44° |
|-------|-----------------------|-------|-----|
| h (m) | E <sub>max</sub> (lx) | d (m) |     |
| 1     | <b>1100</b>           | 0,81  |     |
| 2     | <b>275</b>            | 1,6   |     |
| 3     | <b>122</b>            | 2,4   |     |

CURVES



3300 lm

Corps aluminium/Patère de fixation ronde en acier. Réflecteur aluminium métallisé. Alimentation intégrée.

Version plafonnier



| 33W    | 36°    | 2,1 kg  | 50 000 h |        |
|--------|--------|---------|----------|--------|
| Lumens | Teinte | Couleur | Code     | € HT   |
| 3300   | 3000 K | blanc   | 50371    | 289,70 |
| 3300   | 4000 K | blanc   | 50372    | 289,70 |
| 3300   | 3000 K | noir    | 50699    | 289,70 |
| 3300   | 4000 K | noir    | 50700    | 289,70 |

Version suspension



1,5 m de câble. Possibilité de raccourcir le câble par la patère.

| 33W    | 36°    | 2,1 kg  | 50 000 h |        |
|--------|--------|---------|----------|--------|
| Lumens | Teinte | Couleur | Code     | € HT   |
| 3300   | 3000 K | blanc   | 50373    | 293,80 |
| 3300   | 4000 K | blanc   | 50374    | 293,80 |
| 3300   | 3000 K | noir    | 50697    | 293,80 |
| 3300   | 4000 K | noir    | 50698    | 293,80 |

CÔNES GAMME CURVES

| CURVES | 3000k 33w 36° |                       |       | CURVES | 4000k 33w 36° |                       |       |
|--------|---------------|-----------------------|-------|--------|---------------|-----------------------|-------|
|        | h (m)         | E <sub>max</sub> (lx) | d (m) |        | h (m)         | E <sub>max</sub> (lx) | d (m) |
|        | 1             | 7599                  | 0,65  |        | 1             | 7599                  | 0,65  |
|        | 2             | 1900                  | 1,3   |        | 2             | 1900                  | 1,3   |
|        | 3             | 844                   | 1,9   |        | 3             | 844                   | 1,9   |
|        | 4             | 475                   | 2,6   |        | 4             | 475                   | 2,6   |
|        | 5             | 304                   | 3,2   |        | 5             | 304                   | 3,2   |

## MINI CURVES



400 lm



Corps aluminium/Patère de fixation ronde en aluminium. LED XL6. 1,5 m de câble.  
Possibilité de raccourcir le câble par la patère.  
**Alimentation intégrée.**

**4,8W** **42°** **0,5 kg** **35 000 h**

| Lumens | Teinte | Couleur | Code         | € HT          |
|--------|--------|---------|--------------|---------------|
| 400    | 3000 K | blanc   | <b>50378</b> | <b>112,20</b> |
| 400    | 3000 K | noir    | <b>50710</b> | <b>112,20</b> |

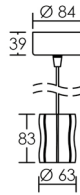

| MINI CURVES | 3000 K                      | 4,8 W        | 42° |
|-------------|-----------------------------|--------------|-----|
| h (m)       | <b>E<sub>max</sub> (lx)</b> | <b>d (m)</b> |     |
| 0,5         | <b>2424</b>                 | 0,38         |     |
| 1           | <b>606</b>                  | 0,77         |     |
| 2           | <b>152</b>                  | 1,5          |     |

## JULIA



400 lm



Corps aluminium/Anneau décoratif en PMMA opale laissant passer la lumière/Patère de fixation ronde en aluminium. LED XL6. 1,5 m de câble.  
Possibilité de raccourcir le câble par la patère.  
**Alimentation intégrée.**

**4,8W** **42°** **0,5 kg** **35 000 h**

| Lumens | Teinte | Couleur | Code         | € HT          |
|--------|--------|---------|--------------|---------------|
| 400    | 3000 K | blanc   | <b>50448</b> | <b>122,40</b> |
| 400    | 3000 K | noir    | <b>50711</b> | <b>122,40</b> |

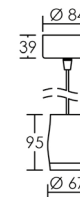

| JULIA | 3000 K                      | 4,8 W        | 42° |
|-------|-----------------------------|--------------|-----|
| h (m) | <b>E<sub>max</sub> (lx)</b> | <b>d (m)</b> |     |
| 0,5   | <b>2424</b>                 | 0,38         |     |
| 1     | <b>606</b>                  | 0,77         |     |
| 2     | <b>152</b>                  | 1,5          |     |

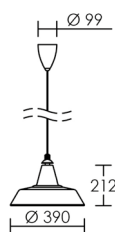

Corps acier. 1,5 m de câble.  
Possibilité de raccourcir le câble par la patère.

## E27

| P (W) | Couleur extérieur | Couleur intérieur | Code sans lampe | € HT         |
|-------|-------------------|-------------------|-----------------|--------------|
| 150   | blanc             | blanc             | <b>4183</b>     | <b>92,40</b> |
| 150   | noir              | blanc             | <b>4184</b>     | <b>92,40</b> |

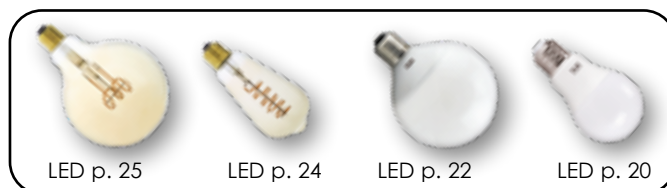

## ROMA

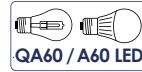

Réflecteur acier/Patère plastique. Câble 1 m.  
Possibilité de raccourcir le câble par la patère.

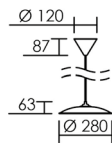

## E27

| P (W) | Couleur extérieur | Couleur intérieur | Code sans lampe | € HT  |
|-------|-------------------|-------------------|-----------------|-------|
| 60    | blanc             | cuivré            | 4204            | 53,00 |
| 60    | noir              | cuivré            | 4205            | 53,00 |

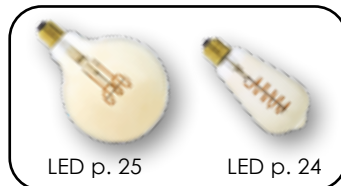

LED p. 25

LED p. 24

COMO

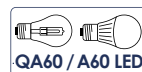

Réflecteur acier/Patère plastique. Câble 1 m. Possibilité de raccourcir le câble par la patère.

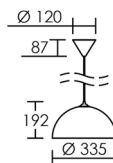

Version intérieur cuivré

| P (w) | Douille | Couleur extérieur | Code sans lampe | € HT  |
|-------|---------|-------------------|-----------------|-------|
| 60    | E27     | blanc             | 4208            | 58,10 |
| 60    | E27     | noir              | 4210            | 58,10 |

Version intérieur blanc

| P (w) | Douille | Couleur extérieur | Code sans lampe | € HT  |
|-------|---------|-------------------|-----------------|-------|
| 60    | E27     | blanc             | 4207            | 35,70 |
| 60    | E27     | noir              | 4209            | 57,10 |

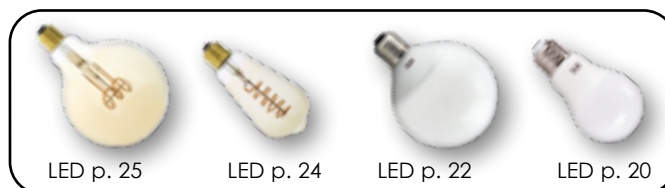



## COOPER

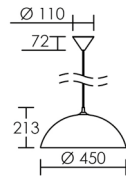

Verre noir/Revêtement intérieur cuivré structuré/  
Patère plastique noir. Câble longueur 1 m.  
Possibilité de raccourcir le câble par la patère.

**2,7 kg**

| P (W) | Douille | Couleur     | Code sans lampe | € HT          |
|-------|---------|-------------|-----------------|---------------|
| 60    | E27     | noir/cuivré | <b>4194</b>     | <b>250,90</b> |

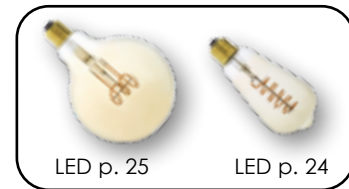

**Dépose manuelle du revêtement intérieur.**  
Attention, son aspect esthétique peut présenter certaines irrégularités.

## ÉPOQUE

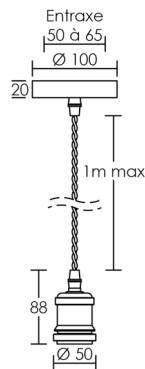

Câble et patère noirs. 1 m de câble torsadé avec gaine.

**0,2 kg**

| P (W) | Douille | Couleur     | Code sans lampe | € HT         |
|-------|---------|-------------|-----------------|--------------|
| 60    | E27     | anthracite  | <b>50449</b>    | <b>12,20</b> |
| 60    | E27     | laiton doré | <b>50450</b>    | <b>12,20</b> |

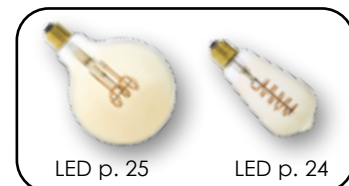

# DIANA 1

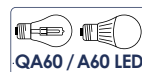

Patère acier chromé/1 verre opale. Câble longueur 1,5 m.

## Version Ø 140 mm



**0,7 kg**

| P (w) | Douille | Verre | Code sans lampe | € HT         |
|-------|---------|-------|-----------------|--------------|
| 75    | E27     | opale | <b>4175</b>     | <b>92,20</b> |

Verre de rechange Ø14 cm, code 1271.

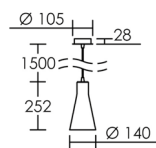

## Version Ø 230 mm



**1,2 kg**

| P (w) | Douille | Verre | Code sans lampe | € HT          |
|-------|---------|-------|-----------------|---------------|
| 75    | E27     | opale | <b>4176</b>     | <b>128,80</b> |

Verre de rechange Ø23 cm, code 1273.

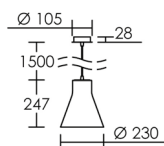

## DIANA 2

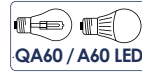

Patère acier chromé/2 verres opaques.  
Câble longueur 1,5 m.

**2,2 kg**

| P (W) | Douille | Verre | Code sans lampe | € HT          |
|-------|---------|-------|-----------------|---------------|
| 2x 60 | E27     | opale | <b>4177</b>     | <b>185,50</b> |

Verre de rechange Ø14 cm, code 1271.

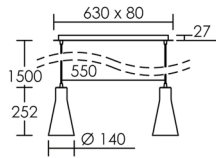

## DIANA 3



Patère acier chromé/3 verres opaques.  
Câble longueur 1,5 m.

**2,9 kg**

| P (W) | Douille | Verre | Code sans lampe | € HT          |
|-------|---------|-------|-----------------|---------------|
| 3x 60 | E27     | opale | <b>4178</b>     | <b>263,60</b> |

Verre de rechange Ø14 cm, code 1271.

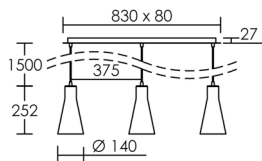

ATON

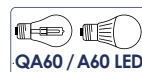

Verre opale/Patère plastique. Câble 1 m. Possibilité de raccourcir le câble par la patère.

Version Ø 150 mm

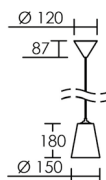

1,2 kg

| P (w) | Douille | Couleur | Code sans lampe | € HT  |
|-------|---------|---------|-----------------|-------|
| 60    | E27     | blanc   | 4190            | 87,70 |
| 60    | E27     | noir    | 4191            | 87,70 |



Version Ø 220 mm

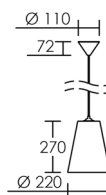

2,5 kg

| P (w) | Douille | Couleur | Code sans lampe | € HT   |
|-------|---------|---------|-----------------|--------|
| 60    | E27     | blanc   | 4192            | 135,70 |
| 60    | E27     | noir    | 4193            | 135,70 |



## NINA



470 lm

Corps aluminium/Patère de fixation ronde en aluminium. 1,5 m de câble. Possibilité de raccourcir le câble par la patère. Livrée avec lampe (code 2981).

6W  $\sphericalangle$  36° 0,5 kg

15 000 h

| Lumens | Teinte | Couleur | Code avec lampe | € HT   |
|--------|--------|---------|-----------------|--------|
| 470    | 3000 K | blanc   | 4253            | 109,00 |
| 470    | 3000 K | noir    | 4254            | 109,00 |

Données de la lampe.



| LED 6E | 3000K          | 6W    | 36° |
|--------|----------------|-------|-----|
| h (m)  | $E_{max}$ (lx) | d (m) |     |
| 1      | 972            | 0,65  |     |
| 2      | 243            | 1,3   |     |
| 2,5    | 156            | 1,6   |     |



## STELA

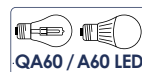

Patère et réflecteur acier. Câble 1 m. Possibilité de raccourcir le câble par la patère.

## Version 1 - Ø 300 mm

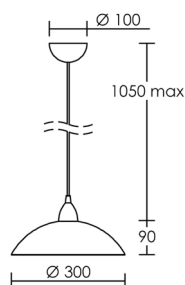

0,65 kg

| P (w) | Douille | Couleur | Code sans lampe | € HT  |
|-------|---------|---------|-----------------|-------|
| 75    | E27     | blanc   | 1634            | 42,70 |



## Version 2 - Ø 380 mm

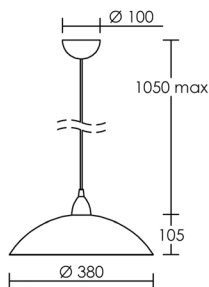

1 kg

| P (w) | Douille | Couleur | Code sans lampe | € HT  |
|-------|---------|---------|-----------------|-------|
| 100   | E27     | blanc   | 1635            | 48,80 |



## SYRA

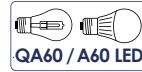

Patère acier/Verre translucide strié. Câble 1 m. Possibilité de raccourcir le câble par la patère.

## Version 1 - Ø 165 mm

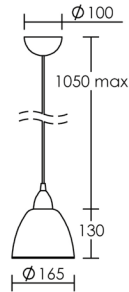

**1 kg**

| P (W) | Douille | Couleur     | Code sans lampe | € HT         |
|-------|---------|-------------|-----------------|--------------|
| 40    | E27     | translucide | <b>0459</b>     | <b>48,70</b> |

Verre de rechange, code **1978**.



## Version 2 - Ø 320 mm

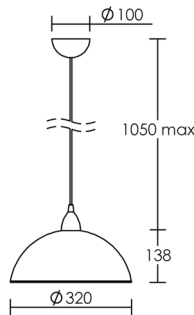

**1,8 kg**

| P (W) | Douille | Couleur     | Code sans lampe | € HT         |
|-------|---------|-------------|-----------------|--------------|
| 75    | E27     | translucide | <b>0481</b>     | <b>78,00</b> |

Verre de rechange, code **1979**.



## Version 3 - Ø 395 mm

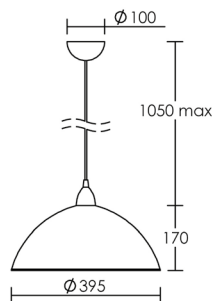

**2,5 kg**

| P (W) | Douille | Couleur     | Code sans lampe | € HT         |
|-------|---------|-------------|-----------------|--------------|
| 100   | E27     | translucide | <b>0482</b>     | <b>88,80</b> |

Verre de rechange, code **1980**.



ASY LED



3100 lm

Corps aluminium anodisé/Ecran polycarbonate opalin. **Alimentation intégrée.** Circuit LED SMD 5630 (IRC >80).  
Filins d'accroche réglables en hauteur 1,5 m max. Fixation au plafond par patère.  
Fixations coulissantes sur les profilés.



Version 22W

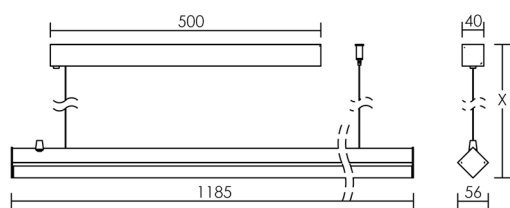

2 kg 35 000 h

| P (w) | Lumens | Teinte | Code  | € HT   |
|-------|--------|--------|-------|--------|
| 22    | 2300   | 3000 K | 50563 | 206,00 |
| 22    | 2500   | 4000 K | 50564 | 206,00 |

Version 27W

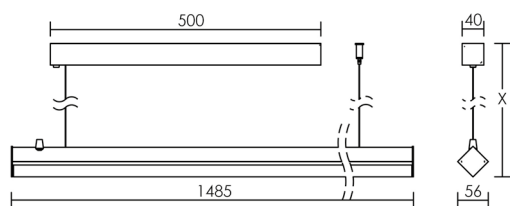

2,2 kg 35 000 h

| P (w) | Lumens | Teinte | Code  | € HT   |
|-------|--------|--------|-------|--------|
| 27    | 2900   | 3000 K | 50565 | 238,70 |
| 27    | 3100   | 4000 K | 50566 | 238,70 |



## LINEAR



3100 lm



Corps aluminium anodisé/Ecran polycarbonate opalin. **Alimentation intégrée**. Circuit LED SMD 5630 (IRC >80). Filins d'accroche réglables en hauteur 1,5 m max. Fixation au plafond par patère. Fixations coulissantes sur les profilés.

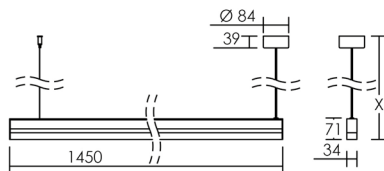

| 27W    | 1,7 kg |         |              |               | 35 000 h |
|--------|--------|---------|--------------|---------------|----------|
| Lumens | Teinte | Couleur | Code         | € HT          |          |
| 2900   | 3000 K | blanc   | <b>50606</b> | <b>238,70</b> |          |
| 3100   | 4000 K | blanc   | <b>50607</b> | <b>238,70</b> |          |
| 2900   | 3000 K | gris    | <b>50568</b> | <b>238,70</b> |          |
| 3100   | 4000 K | gris    | <b>50569</b> | <b>238,70</b> |          |
| 2900   | 3000 K | noir    | <b>50608</b> | <b>238,70</b> |          |
| 3100   | 4000 K | noir    | <b>50609</b> | <b>238,70</b> |          |

LAMPE

DOWNLIGHT  
ENCASTRERAIL  
PROJECTEUR  
SPOTERIE

RÉGLLETTE

RUBAN  
PROFILÉ

SUSPENSION

## SORA

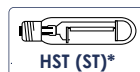

Corps polycarbonate/Verre de protection.

## Version translucide



3,1 kg

| P (w) | Douille | Couleur     | Code sans lampe | € HT   |
|-------|---------|-------------|-----------------|--------|
| 100   | E27     | translucide | 1638            | 131,80 |

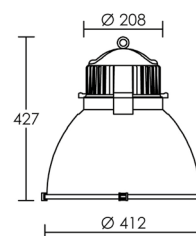

## Version aluminium



3,1 kg

| P (w) | Douille | Couleur   | Code sans lampe | € HT   |
|-------|---------|-----------|-----------------|--------|
| 100   | E27     | aluminium | 1659            | 162,80 |

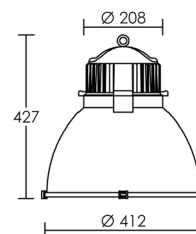

## KIT DE SUSPENSION

Rosace transparente, 2 m filin d'acier + 2 m câble 2x 0,75 mm<sup>2</sup>, serre-câble.

| Code | € HT  |
|------|-------|
| 2054 | 21,30 |

\* HST (ST) = 70W halogène tubulaire

LEXA



4000 lm

Corps aluminium/Réflecteur polycarbonate strié. Précâblage 3 m. Possibilité de raccourcir le câble.  
Alimentation intégrée.

## Version réflecteur translucide

40W  $\angle 80^\circ$  2,7 kg 35 000 h

| Lumens | Teinte | Couleur corps | Code         | € HT          |
|--------|--------|---------------|--------------|---------------|
| 4000   | 3000 K | blanc         | <b>50763</b> | <b>274,40</b> |
| 4000   | 4000 K | blanc         | <b>50764</b> | <b>274,40</b> |
| 4000   | 3000 K | noir          | <b>50765</b> | <b>274,40</b> |
| 4000   | 4000 K | noir          | <b>50766</b> | <b>274,40</b> |

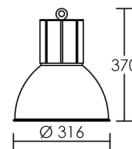

| LEXA  | 3/4000K        | 40W   | 80° |
|-------|----------------|-------|-----|
| h (m) | $E_{max}$ (lx) | d (m) |     |
| 1     | <b>3012</b>    | 1,68  |     |
| 2     | <b>753</b>     | 3,4   |     |
| 3     | <b>335</b>     | 5,0   |     |
| 4     | <b>188</b>     | 6,7   |     |
| 5     | <b>120</b>     | 8,4   |     |

## Version réflecteur blanc

40W  $\angle 80^\circ$  2,7 kg 35 000 h

| Lumens | Teinte | Couleur corps | Code         | € HT          |
|--------|--------|---------------|--------------|---------------|
| 4000   | 3000 K | blanc         | <b>50508</b> | <b>274,40</b> |
| 4000   | 4000 K | blanc         | <b>50509</b> | <b>274,40</b> |
| 4000   | 3000 K | noir          | <b>50712</b> | <b>274,40</b> |
| 4000   | 4000 K | noir          | <b>50713</b> | <b>274,40</b> |

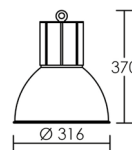

| LEXA  | 3/4000K        | 40W   | 80° |
|-------|----------------|-------|-----|
| h (m) | $E_{max}$ (lx) | d (m) |     |
| 1     | <b>3012</b>    | 1,68  |     |
| 2     | <b>753</b>     | 3,4   |     |
| 3     | <b>335</b>     | 5,0   |     |
| 4     | <b>188</b>     | 6,7   |     |
| 5     | <b>120</b>     | 8,4   |     |

## KIT DE SUSPENSION



Patère acier diamètre 98 mm. Filin acier longueur 3 m max.

| Couleur | Code         | € HT         |
|---------|--------------|--------------|
| blanc   | <b>50011</b> | <b>36,30</b> |
| noir    | <b>50012</b> | <b>36,30</b> |

COMO rail

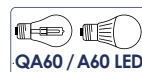

Réflecteur acier. Adaptateur fourni. Câble 1 m.



Version 029 - Pour rail 1 allumage (p. 125)



0,9 kg

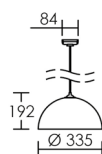

| P (W) | Douille | Couleur int./ext. | Code sans lampe | € HT  |
|-------|---------|-------------------|-----------------|-------|
| 60    | E27     | cuirré/noir       | 4217            | 70,40 |
| 60    | E27     | blanc/blanc       | 4214            | 47,90 |

Version 023 - Pour rail 3 allumages (p. 124)



0,9 kg

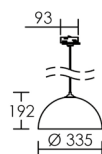

| P (W) | Douille | Couleur int./ext. | Code sans lampe | € HT  |
|-------|---------|-------------------|-----------------|-------|
| 60    | E27     | cuirré/noir       | 4218            | 70,40 |
| 60    | E27     | blanc/blanc       | 4216            | 47,90 |



**CURVES 023**

Pour rail 3 allum. (p. 124)



3300 lm



Corps aluminium/Réflecteur aluminium métallisé.  
Alimentation intégrée.



**33W**  $\angle 36^\circ$  **2,1 kg** **50 000 h**

| Lumens | Teinte | Couleur | Code         | € HT          |
|--------|--------|---------|--------------|---------------|
| 3300   | 3000 K | blanc   | <b>50693</b> | <b>306,00</b> |
| 3300   | 4000 K | blanc   | <b>50694</b> | <b>306,00</b> |
| 3300   | 3000 K | noir    | <b>50695</b> | <b>306,00</b> |
| 3300   | 4000 K | noir    | <b>50696</b> | <b>306,00</b> |

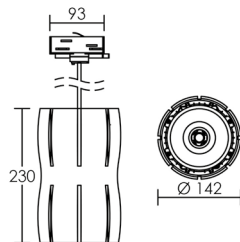

**CÔNES GAMME CURVES**

| CURVES 3000k 33w 36° |                       |       |  | CURVES 4000k 33w 36° |                       |       |  |
|----------------------|-----------------------|-------|--|----------------------|-----------------------|-------|--|
| h (m)                | E <sub>max</sub> (lx) | d (m) |  | h (m)                | E <sub>max</sub> (lx) | d (m) |  |
| 1                    | 7599                  | 0,65  |  | 1                    | 7599                  | 0,65  |  |
| 2                    | 1900                  | 1,3   |  | 2                    | 1900                  | 1,3   |  |
| 3                    | 844                   | 1,9   |  | 3                    | 844                   | 1,9   |  |
| 4                    | 475                   | 2,6   |  | 4                    | 475                   | 2,6   |  |
| 5                    | 304                   | 3,2   |  | 5                    | 304                   | 3,2   |  |

LAMPE

DOWNLIGHT ENCASTRE

RAIL PROJECTEUR SPOTERIE

RÉGLLETTE

RUBAN PROFILÉ

SUSPENSION

LEXA 023

Pour rail 3 allum. (p. 124)



4000 lm

Corps aluminium/Réflecteur polycarbonate strié. Alimentation intégrée.

Version réflecteur translucide



40W ◀ 80° 2,7 kg 35 000 h

| Lumens | Teinte | Couleur corps | Code  | € HT   |
|--------|--------|---------------|-------|--------|
| 4000   | 3000 K | blanc         | 50757 | 286,60 |
| 4000   | 4000 K | blanc         | 50758 | 286,60 |
| 4000   | 3000 K | noir          | 50761 | 286,60 |
| 4000   | 4000 K | noir          | 50762 | 286,60 |

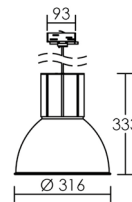

| LEXA  | 3/4000K        | 40W   | 80° |
|-------|----------------|-------|-----|
| h (m) | $E_{max}$ (lx) | d (m) |     |
| 1     | 3012           | 1,68  |     |
| 2     | 753            | 3,4   |     |
| 3     | 335            | 5,0   |     |
| 4     | 188            | 6,7   |     |
| 5     | 120            | 8,4   |     |

Version réflecteur blanc



40W ◀ 80° 2,7 kg 35 000 h

| Lumens | Teinte | Couleur corps | Code  | € HT   |
|--------|--------|---------------|-------|--------|
| 4000   | 3000 K | blanc         | 50755 | 286,60 |
| 4000   | 4000 K | blanc         | 50756 | 286,60 |
| 4000   | 3000 K | noir          | 50759 | 286,60 |
| 4000   | 4000 K | noir          | 50760 | 286,60 |

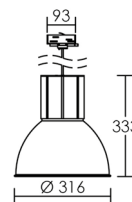

| LEXA  | 3/4000K        | 40W   | 80° |
|-------|----------------|-------|-----|
| h (m) | $E_{max}$ (lx) | d (m) |     |
| 1     | 3012           | 1,68  |     |
| 2     | 753            | 3,4   |     |
| 3     | 335            | 5,0   |     |
| 4     | 188            | 6,7   |     |
| 5     | 120            | 8,4   |     |

HIGH BAY DIM



26 000 lm

Corps en fonderie d'aluminium noir/Lentille polycarbonate. **Alimentation intégrée.**  
 Crochet de suspension et filin d'acier de sécurité fournis. Sur chaque appareil :  
 précâblage H05RN-F 3x 1 mm² lg. 0,3 m avec connecteur IP68 pour raccordement 230V ;  
 précâblage H05RN-F 2x 1 mm² lg. 0,3 m avec connecteur IP68 pour raccordement 1-10V.

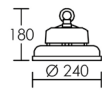

Version 100W-150W

Version faisceau 110°

| ○ 4000 K     |        | ◁ 110°     |              | 50 000 h      |  |
|--------------|--------|------------|--------------|---------------|--|
| P (w)        | Lumens | Poids (kg) | Code         | € HT          |  |
| <b>N</b> 100 | 13000  | 2,5        | <b>50884</b> | <b>227,00</b> |  |
| <b>N</b> 150 | 19500  | 2,9        | <b>50885</b> | <b>257,00</b> |  |
| <b>N</b> 200 | 26000  | 3,5        | <b>50886</b> | <b>313,00</b> |  |

Dimmable en 1-10V

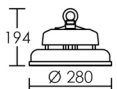

Version 200W

Version faisceau 60°

| ○ 4000 K     |        | ◁ 60°      |              | 50 000 h      |  |
|--------------|--------|------------|--------------|---------------|--|
| P (w)        | Lumens | Poids (kg) | Code         | € HT          |  |
| <b>N</b> 100 | 13000  | 2,5        | <b>50887</b> | <b>226,00</b> |  |
| <b>N</b> 150 | 19500  | 2,9        | <b>50888</b> | <b>254,00</b> |  |
| <b>N</b> 200 | 26000  | 3,5        | <b>50889</b> | <b>308,00</b> |  |

Dimmable en 1-10V

CÔNES GAMME HIGH BAY

| Code  | Température | Puissance | Faisceau | h (m) | E <sub>max</sub> (lx) | d (m) |
|-------|-------------|-----------|----------|-------|-----------------------|-------|
| 50884 | 4000K       | 100 W     | 110°     | 1     | 4946                  | 2,86  |
|       |             |           |          | 3     | 550                   | 8,6   |
|       |             |           |          | 6     | 137                   | 17,1  |
|       |             |           |          | 9     | 61                    | 25,7  |
|       |             |           |          | 12    | 34                    | 34,3  |
| 50885 | 4000K       | 150 W     | 110°     | 1     | 7420                  | 2,86  |
|       |             |           |          | 3     | 824                   | 8,6   |
|       |             |           |          | 6     | 206                   | 17,1  |
|       |             |           |          | 9     | 92                    | 25,7  |
|       |             |           |          | 12    | 52                    | 34,3  |
| 50886 | 4000K       | 200 W     | 110°     | 1     | 9893                  | 2,86  |
|       |             |           |          | 3     | 1099                  | 8,6   |
|       |             |           |          | 6     | 275                   | 17,1  |
|       |             |           |          | 9     | 122                   | 25,7  |
|       |             |           |          | 14    | 50                    | 40,0  |
| 50887 | 4000K       | 100 W     | 60°      | 1     | 12625                 | 1,15  |
|       |             |           |          | 3     | 1403                  | 3,5   |
|       |             |           |          | 6     | 351                   | 6,9   |
|       |             |           |          | 9     | 156                   | 10,4  |
|       |             |           |          | 12    | 88                    | 13,9  |
| 50888 | 4000K       | 150 W     | 60°      | 1     | 19840                 | 1,15  |
|       |             |           |          | 3     | 2204                  | 3,5   |
|       |             |           |          | 6     | 551                   | 6,9   |
|       |             |           |          | 9     | 245                   | 10,4  |
|       |             |           |          | 12    | 138                   | 13,9  |
| 50889 | 4000K       | 200 W     | 60°      | 1     | 31007                 | 1,15  |
|       |             |           |          | 3     | 3445                  | 3,5   |
|       |             |           |          | 6     | 861                   | 6,9   |
|       |             |           |          | 9     | 383                   | 10,4  |
|       |             |           |          | 14    | 158                   | 16,2  |



Connecteur IP68 précâblé

ACCESSOIRES



| Version     | Désignation          | Code         | € HT         |
|-------------|----------------------|--------------|--------------|
| 100W - 150W | Réflecteur aluminium | <b>50890</b> | <b>34,00</b> |
| 200 W       | Réflecteur aluminium | <b>50891</b> | <b>40,00</b> |

# SOMMAIRE | EXTÉRIEUR : PROJECTEUR

## PROJECTEUR LED

TWISTER 3 .....p. 300



TWISTER 3  
ASYMÉTRIQUE .....p. 302



TWISTER 3 HIGH POWER  
ASYMÉTRIQUE .....p. 303



ACCESSOIRES  
TWISTER 3 .....p. 304



TWISTER 3 HIGH  
POWER .....p. 305



TWISTER 3  
SENSOR .....p. 307



MICHELLE .....p. 309



SUNSET .....p. 310



SUNSET-E .....p. 311



WINK .....p. 312



WINK SENSOR .....p. 313



ELFI .....p. 314



ZODIAK .....p. 315



## Comment bien choisir son projecteur ?

Ce guide vous permettra de trouver la solution technique la plus adaptée.

### 1/ À quelle application est destinée le projecteur ?

#### GRANDE HAUTEUR

- ▶ Éclairage des bâtiments de plus de 8 m de haut
- ▶ Éclairage puissant et dirigé

#### ENTREPÔT

- ▶ Éclairage soutenu non directionnel
- ▶ Grands aplats de lumière

#### PARKING

- ▶ Projecteur dédié à la mise sur mât standard (Ø60 mm) grâce à son embout de fixation dédié

#### ESPACE VERT

- ▶ Éclairage des parcs et des jardins
- ▶ Grands volumes et accentuation

#### SHOP

- ▶ Projecteur au design ultra plat pour une bonne intégration sur les façades
- ▶ Éclairage des commerces, des circulations ou du bâti

#### RÉSIDENTIEL

- ▶ Projecteur adapté à l'habitat (taille et flux)
- ▶ Application : circulation, garage, entrée

### 2/ Quel est l'effet de mise en lumière recherché ?

#### INTENSIF

Besoin de cibler la lumière pour éclairer un objet précis ou pour souligner l'architecture.

#### EXTENSIF

Besoin d'obtenir un grand aplat de lumière pour de grandes surfaces à éclairer ou pour des raisons de sécurité.

### 3/ L'intégration esthétique du projecteur est-elle déterminante ?

#### FAÇADE

Certains projecteurs bénéficient d'un design ultra plat pour répondre aux contraintes esthétiques et d'intégration de l'éclairage sur les bâtiments.



# SOMMAIRE | EXTÉRIEUR : PROJECTEUR

## PROJECTEUR FAÇADE ENSEIGNE

**TAG** .....p. 316



**DIA** .....p. 317



**ZURO LED** .....p. 318



## PROJECTEUR POUR LAMPE R7s

**MX 1500** .....p. 320



**MX 1000** .....p. 320



**ZENITH** .....p. 321



**JUNIOR** .....p. 321



## PROJECTEUR DE JARDIN

**DAFNEE** .....p. 322



**ELFI** .....p. 322



**TOPAZE** .....p. 322



**KIT ASTER** .....p. 324



**SUKO** .....p. 324



**TELO LED** .....p. 324



## PROJECTEUR IMMERGEABLE

**SUB 50** .....p. 325



**KIT SUB 50** .....p. 325



LAMPE

DOWNLIGHT  
ENCASTRE

RAIL  
PROJECTEUR  
SPOTERIE

RÉGLLETTE

RUBAN  
PROFILÉ

APPLIQUE  
PLAFONNIER  
SUSPENSION

EXTÉRIEUR :  
PROJECTEUR



## ARRÊTÉ DU 27 DÉCEMBRE 2018

### RELATIF À LA PRÉVENTION, À LA RÉDUCTION ET À LA LIMITATION DES NUISANCES LUMINEUSES



**NOTA :** la mesure est **PROGRESSIVE** ! L'objectif n'est pas de changer l'ensemble des luminaires au 1<sup>er</sup> janvier 2020, mais bien de prendre en compte ces nouvelles réglementations en cas de renouvellement du parc de luminaires.

- ➔ **Exigences applicables pour toutes les nouvelles installations extérieures, dès le 1<sup>er</sup> janvier 2020.**
- ➔ **Pour le parc existant**
  - si les travaux ne nécessitent pas la création d'un réseau d'alimentation séparé, **les luminaires doivent se conformer aux plages horaires mentionnées dans l'arrêté d'ici le 1<sup>er</sup> janvier 2021.**
  - **si les luminaires ont une proportion de lumière supérieure à 50 % au-dessus de l'horizontale (lampes boules par exemple), ceux-ci doivent être changés au plus tard au 1<sup>er</sup> janvier 2025.**
  - Pour les réserves naturelles, les parcs nationaux, les parcs naturels régionaux et marins, le préfet pourra prendre des prescriptions plus strictes dès le 1<sup>er</sup> janvier 2020 par arrêté préfectoral.

#### Principes généraux



✓ **Température de couleur ≤ 3000 K** (sauf exceptions).  
**Toutes nos gammes de projecteurs** sont désormais disponibles en 3000 K, et parfois même en 2400 K (**TWISTER 3**)!



| < ● 2400 K   | < ● 3000 K   | ● 4000 K et plus...   |
|--|--|---|
| Voirie, parcs de stationnements hors agglomération dans parc naturel                       | Voirie, parcs citadins et de stationnements en extérieur | Équipements sportifs de plein air ou découvrables (Pas d'exigences, sauf art. 3. II 4° (PMR) et art. 4. (sites naturels)) |
| Voirie, parcs citadins, stationnements, et mise en lumière du patrimoine dans parc naturel |  | Mise en lumière du patrimoine en agglomération  |
|  |  | Usage privé : jardin, terrasse, garage (s'il ne donne pas directement sur la rue)   |

✓ Il est désormais interdit de diriger de la lumière vers le ciel :

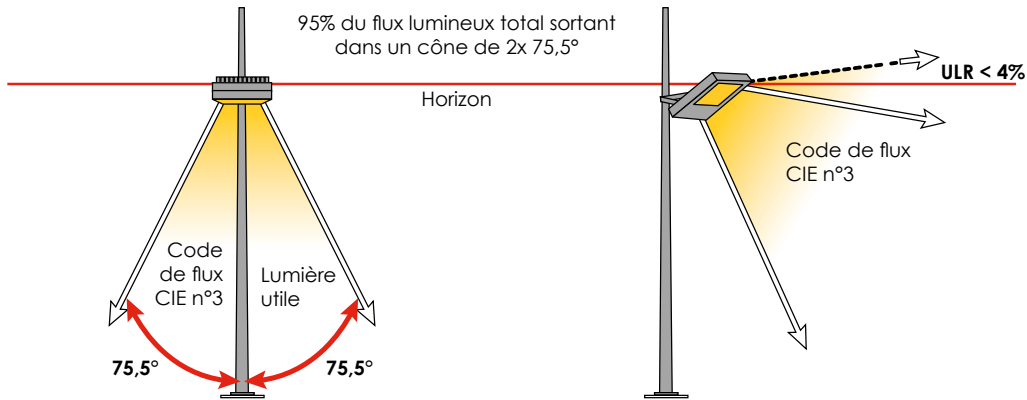

➔ Plusieurs critères sont à prendre en compte :

- **Code de flux CIE n°3** : pourcentage de lumière émise dans un cône de demi-angle de 75,5° des 180° inférieurs. La lumière émise au-delà de cet angle est considérée comme polluante, éblouissante et perdue. L'arrêté requiert une proportion > 95%.
- **Proportion de lumière émise au-dessus de l'horizontale** = ULR du luminaire installé < 4 %



**Sur tous nos projecteurs TWISTER 3**, un repère vous permet de régler l'inclinaison maximale pour respecter un **ULR < 4%**

- **Densité surfacique** de flux lumineux équivalent à une intensité lumineuse permettant de circuler dans la rue de nuit sans difficulté :
  - en agglomération : 35 lumens par mètre carré
  - hors agglomération : < 25 lumens par mètre carré

Retrouvez l'ensemble des données nécessaires aux calculs ci-dessus dans les fichiers photométriques à exploiter sous Dialux, disponibles sur notre site [www.aric-sa.fr](http://www.aric-sa.fr)

✓ Des plages horaires renforcées pour l'allumage / extinction des éclairages.

| NOUVEAUTÉ   | RAPPEL  | NOUVEAUTÉ   |
|---|---|---|
| <b>PARKINGS*</b>  | <b>BÂTIMENTS NON RÉSIDENTIELS** ET VITRINES</b>   | <b>PATRIMOINE</b>   |
| <b>Allumage :</b><br>au coucher du soleil<br><b>Extinction :</b><br>2h après la fin de l'activité<br><b>Allumage :</b><br>7h du matin ou<br>1h avant le début de l'activité | <b>Allumage :</b><br>7h du matin ou<br>1h avant le début de l'activité<br><b>Extinction :</b><br>1h après la fin de l'occupation des locaux | <b>Allumage :</b><br>au coucher du soleil<br><b>Extinction :</b><br>1h du matin<br><b>Extinction pour les parcs et jardins :</b><br>1h après la fermeture |

\* Parkings : parcs de stationnement non couverts ou semi-couverts.

\*\* Bâtiments non résidentiels : bâtiments accueillant des activités diverses, non résidentielles, éclairant vers l'extérieur ou émettant de la lumière à l'intérieur du bâtiment. Sont également concernées les illuminations de ces bâtiments.



**L'utilisation de la détection de présence ou crépusculaire** permet d'adapter cette partie de l'arrêté selon cas définis dans l'Arrêté, (voir nos gammes **TWISTER 3 SENSOR**, **WINK SENSOR**...)

Pour plus de précisions, se référer au texte officiel [www.legifrance.gouv.fr](http://www.legifrance.gouv.fr) ou s'adresser au Syndicat de l'éclairage sur [www.syndicat-eclairage.com](http://www.syndicat-eclairage.com)

**TWISTER 3 GRIS**

Extensif



Jusqu'à  
**13 000 lm**

Corps aluminium/Verre de protection. Précâblage H05RN-F 3G 1 mm<sup>2</sup> long. 0,85 m sur les versions 12W, 25W, 45W. Précâblage H05RN-F 3G 1 mm<sup>2</sup> long. 0,20 m **avec connecteur IP68** pour les versions 70W et 100W.



Repère de l'inclinaison maximale pour respecter un ULR <4% (Art 3)



**100 W**

**70 W**

**45 W**

**25 W**

**12 W**

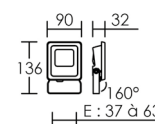
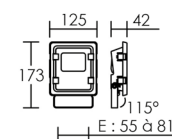
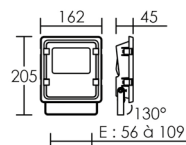
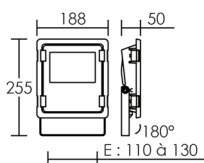
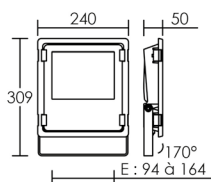

Version **3000 K**

Version **4000 K**



| 90°   |        | 50 000 h   |              |               |  |
|-------|--------|------------|--------------|---------------|--|
| P (w) | Lumens | Poids (kg) | Code         | € HT          |  |
| N 12  | 1450   | 0,37       | <b>50831</b> | <b>31,00</b>  |  |
| N 25  | 3000   | 0,62       | <b>50833</b> | <b>49,00</b>  |  |
| N 45  | 5400   | 0,98       | <b>50835</b> | <b>85,00</b>  |  |
| N 70  | 8400   | 1,55       | <b>50837</b> | <b>147,00</b> |  |
| N 100 | 12000  | 2,57       | <b>50839</b> | <b>193,00</b> |  |

| 90°   |        | 50 000 h   |              |               |  |
|-------|--------|------------|--------------|---------------|--|
| P (w) | Lumens | Poids (kg) | Code         | € HT          |  |
| N 12  | 1550   | 0,37       | <b>50830</b> | <b>31,00</b>  |  |
| N 25  | 3250   | 0,62       | <b>50832</b> | <b>49,00</b>  |  |
| N 45  | 5850   | 0,98       | <b>50834</b> | <b>85,00</b>  |  |
| N 70  | 9100   | 1,55       | <b>50836</b> | <b>147,00</b> |  |
| N 100 | 13000  | 2,57       | <b>50838</b> | <b>193,00</b> |  |

**CÔNES DE LA GAMME TWISTER 3 GRIS**

| Code  | Température | Puissance | Angle | h (m) | E <sub>max</sub> (lx) | d (m) |
|-------|-------------|-----------|-------|-------|-----------------------|-------|
| 50839 | 3000K       | 100W      | 90°   | 1     | 6558                  | 2,0   |
|       |             |           |       | 2     | 1640                  | 4,0   |
|       |             |           |       | 3     | 729                   | 6,0   |
|       |             |           |       | 9     | 81                    | 18,0  |
|       |             |           |       | 12    | 46                    | 24,0  |
| 50837 | 3000K       | 70W       | 90°   | 1     | 4905                  | 2,0   |
|       |             |           |       | 2     | 1226                  | 4,0   |
|       |             |           |       | 3     | 545                   | 6,0   |
|       |             |           |       | 9     | 61                    | 18,0  |
|       |             |           |       | 12    | 34                    | 24,0  |
| 50835 | 3000K       | 45W       | 90°   | 1     | 2713                  | 2,0   |
|       |             |           |       | 2     | 678                   | 4,0   |
|       |             |           |       | 3     | 301                   | 6,0   |
|       |             |           |       | 4     | 170                   | 8,0   |
|       |             |           |       | 5     | 109                   | 10,0  |
| 50833 | 3000K       | 25W       | 90°   | 1     | 1501                  | 2,0   |
|       |             |           |       | 2     | 375                   | 4,0   |
|       |             |           |       | 3     | 167                   | 6,0   |
|       |             |           |       | 4     | 94                    | 8,0   |
|       |             |           |       | 5     | 60                    | 10,0  |
| 50831 | 3000K       | 12W       | 90°   | 1     | 747                   | 2,0   |
|       |             |           |       | 2     | 187                   | 4,0   |
|       |             |           |       | 3     | 83                    | 6,0   |
|       |             |           |       | 4     | 47                    | 8,0   |
|       |             |           |       | 5     | 30                    | 10,0  |
| 50838 | 4000K       | 100W      | 90°   | 1     | 7105                  | 2,0   |
|       |             |           |       | 2     | 1776                  | 4,0   |
|       |             |           |       | 3     | 789                   | 6,0   |
|       |             |           |       | 9     | 88                    | 18,0  |
|       |             |           |       | 12    | 49                    | 24,0  |
| 50836 | 4000K       | 70W       | 90°   | 1     | 5118                  | 2,0   |
|       |             |           |       | 2     | 1280                  | 4,0   |
|       |             |           |       | 3     | 569                   | 6,0   |
|       |             |           |       | 9     | 63                    | 18,0  |
|       |             |           |       | 12    | 36                    | 24,0  |
| 50834 | 4000K       | 45W       | 90°   | 1     | 2953                  | 2,0   |
|       |             |           |       | 2     | 738                   | 4,0   |
|       |             |           |       | 3     | 328                   | 6,0   |
|       |             |           |       | 4     | 185                   | 8,0   |
|       |             |           |       | 5     | 118                   | 10,0  |
| 50832 | 4000K       | 25W       | 90°   | 1     | 1608                  | 2,0   |
|       |             |           |       | 2     | 402                   | 4,0   |
|       |             |           |       | 3     | 179                   | 6,0   |
|       |             |           |       | 4     | 101                   | 8,0   |
|       |             |           |       | 5     | 64                    | 10,0  |
| 50830 | 4000K       | 12W       | 90°   | 1     | 789                   | 2,0   |
|       |             |           |       | 2     | 197                   | 4,0   |
|       |             |           |       | 3     | 88                    | 6,0   |
|       |             |           |       | 4     | 49                    | 8,0   |
|       |             |           |       | 5     | 32                    | 10,0  |

**TWISTER 3 NOIR**

Extensif



Jusqu'à  
**13 000 lm**

Corps aluminium/Verre de protection. Précâblage H05RN-F 3G 1 mm<sup>2</sup> long. 0,85 m sur les versions 12W, 25W, 45W.  
Précâblage H05RN-F 3G 1 mm<sup>2</sup> long. 0,20 m **avec connecteur IP68** pour les versions 70W et 100W.

Repère de l'inclinaison  
maximale pour respecter  
un ULR <4% (Art 3)



**100 W**

**70 W**

**45 W**

**25 W**

**12 W**

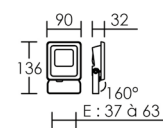
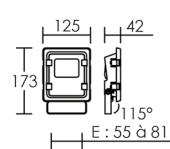
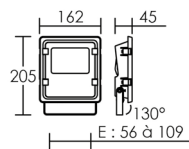
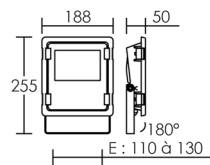
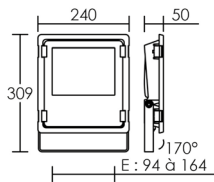

**Version ● 2400 K**

**Version ○ 3000 K**

| ◀ 90°        |        | 50 000 h   |              |               |  |
|--------------|--------|------------|--------------|---------------|--|
| P (w)        | Lumens | Poids (kg) | Code         | € HT          |  |
| <b>N</b> 12  | 1300   | 0,37       | <b>50820</b> | <b>31,00</b>  |  |
| <b>N</b> 25  | 2750   | 0,62       | <b>50822</b> | <b>49,00</b>  |  |
| <b>N</b> 45  | 4950   | 0,98       | <b>50824</b> | <b>85,00</b>  |  |
| <b>N</b> 70  | 7700   | 1,55       | <b>50826</b> | <b>147,00</b> |  |
| <b>N</b> 100 | 11000  | 2,57       | <b>50828</b> | <b>193,00</b> |  |

| ◀ 90°        |        | 50 000 h   |              |               |  |
|--------------|--------|------------|--------------|---------------|--|
| P (w)        | Lumens | Poids (kg) | Code         | € HT          |  |
| <b>N</b> 12  | 1450   | 0,37       | <b>50821</b> | <b>31,00</b>  |  |
| <b>N</b> 25  | 3000   | 0,62       | <b>50823</b> | <b>49,00</b>  |  |
| <b>N</b> 45  | 5400   | 0,98       | <b>50825</b> | <b>85,00</b>  |  |
| <b>N</b> 70  | 8400   | 1,55       | <b>50827</b> | <b>147,00</b> |  |
| <b>N</b> 100 | 12000  | 2,57       | <b>50829</b> | <b>193,00</b> |  |

**CÔNES DE LA GAMME TWISTER 3 NOIR**

| Code  | Température | Puissance | Angle | h (m) | E <sub>max</sub> (lx) | d (m) |
|-------|-------------|-----------|-------|-------|-----------------------|-------|
| 50828 | 2400K       | 100W      | 90°   | 1     | 5956                  | 2,0   |
|       |             |           |       | 2     | 1489                  | 4,0   |
|       |             |           |       | 3     | 662                   | 6,0   |
|       |             |           |       | 9     | 74                    | 18,0  |
|       |             |           |       | 12    | 41                    | 24,0  |
| 50826 | 2400K       | 70W       | 90°   | 1     | 4334                  | 2,0   |
|       |             |           |       | 2     | 1084                  | 4,0   |
|       |             |           |       | 3     | 482                   | 6,0   |
|       |             |           |       | 9     | 54                    | 18,0  |
|       |             |           |       | 12    | 30                    | 24,0  |
| 50824 | 2400K       | 45W       | 90°   | 1     | 2348                  | 2,0   |
|       |             |           |       | 2     | 587                   | 4,0   |
|       |             |           |       | 3     | 261                   | 6,0   |
|       |             |           |       | 4     | 147                   | 8,0   |
|       |             |           |       | 5     | 94                    | 10,0  |
| 50822 | 2400K       | 25W       | 90°   | 1     | 1421                  | 2,0   |
|       |             |           |       | 2     | 355                   | 4,0   |
|       |             |           |       | 3     | 158                   | 6,0   |
|       |             |           |       | 4     | 89                    | 8,0   |
|       |             |           |       | 5     | 57                    | 10,0  |
| 50820 | 2400K       | 12W       | 90°   | 1     | 662                   | 2,0   |
|       |             |           |       | 2     | 166                   | 4,0   |
|       |             |           |       | 3     | 74                    | 6,0   |
|       |             |           |       | 4     | 41                    | 8,0   |
|       |             |           |       | 5     | 26                    | 10,0  |
| 50829 | 3000K       | 100W      | 90°   | 1     | 6558                  | 2,0   |
|       |             |           |       | 2     | 1640                  | 4,0   |
|       |             |           |       | 3     | 729                   | 6,0   |
|       |             |           |       | 9     | 81                    | 18,0  |
|       |             |           |       | 12    | 46                    | 24,0  |
| 50827 | 3000K       | 70W       | 90°   | 1     | 4905                  | 2,0   |
|       |             |           |       | 2     | 1226                  | 4,0   |
|       |             |           |       | 3     | 545                   | 6,0   |
|       |             |           |       | 9     | 61                    | 18,0  |
|       |             |           |       | 12    | 34                    | 24,0  |
| 50825 | 3000K       | 45W       | 90°   | 1     | 2713                  | 2,0   |
|       |             |           |       | 2     | 678                   | 4,0   |
|       |             |           |       | 3     | 301                   | 6,0   |
|       |             |           |       | 4     | 170                   | 8,0   |
|       |             |           |       | 5     | 109                   | 10,0  |
| 50823 | 3000K       | 25W       | 90°   | 1     | 1501                  | 2,0   |
|       |             |           |       | 2     | 375                   | 4,0   |
|       |             |           |       | 3     | 167                   | 6,0   |
|       |             |           |       | 4     | 94                    | 8,0   |
|       |             |           |       | 5     | 60                    | 10,0  |
| 50821 | 3000K       | 12W       | 90°   | 1     | 747                   | 2,0   |
|       |             |           |       | 2     | 187                   | 4,0   |
|       |             |           |       | 3     | 83                    | 6,0   |
|       |             |           |       | 4     | 47                    | 8,0   |
|       |             |           |       | 5     | 30                    | 10,0  |

# TWISTER 3 ASYMÉTRIQUE

Extensif



Jusqu'à  
**11 000 lm**

Corps aluminium/Verre de protection. Alimentation intégrée. Précâblage H05RN-F 3G 1 mm<sup>2</sup>, long. 0,80 m sur version 45W, et H05RN-F 3G 1 mm<sup>2</sup>, long. 0,20 m, **avec connecteur IP68**, sur versions 70W et 100W.



**100 W**

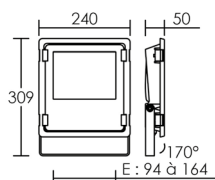

**70 W**

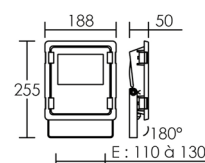

**45 W**

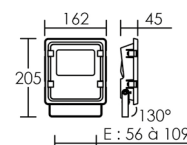

Repère de l'inclinaison maximale pour respecter un ULR <4% (Art 3)

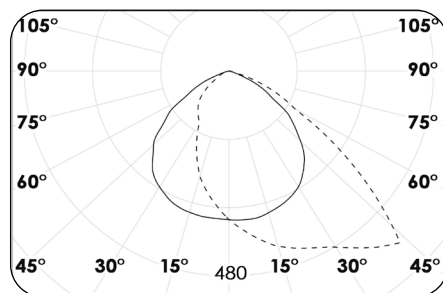

CD/klm  $\eta = 100\%$   
C0 - C180 --- C90 - C270



## Version 45W

**45W**  $\triangleleft 105^\circ \times 65^\circ$  **0,98 kg** **50 000 h**

| Lumens | Teinte | Couleur | Code  | € HT   |
|--------|--------|---------|-------|--------|
| 4950   | 3000 K | gris    | 50870 | 119,00 |

## Version 70W

**70W**  $\triangleleft 105^\circ \times 65^\circ$  **1,55 kg** **50 000 h**

| Lumens | Teinte | Couleur | Code  | € HT   |
|--------|--------|---------|-------|--------|
| 7700   | 3000 K | gris    | 50871 | 180,00 |

## Version 100W

**100W**  $\triangleleft 105^\circ \times 65^\circ$  **2,57 kg** **50 000 h**

| Lumens | Teinte | Couleur | Code  | € HT   |
|--------|--------|---------|-------|--------|
| 11000  | 3000 K | gris    | 50872 | 240,00 |
| 10000  | 2400 K | noir    | 50873 | 240,00 |

# TWISTER 3 HIGH POWER ASYMÉTRIQUE

Extensif



Jusqu'à  
**22 500 lm**

Corps aluminium/Verre de protection. Précâblage H05RN-F 3G 1 mm<sup>2</sup> long. 0,20 m, avec connecteur IP68.



**180 W**

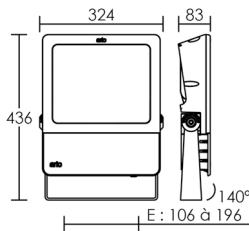

**250 W**

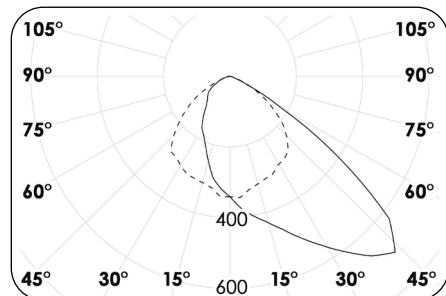
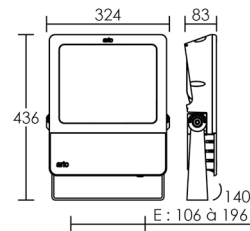

CD/klm  
C0 - C180 --- C90 - C270  
η = 100%

## Version 180W

|              |              |               |                     |
|--------------|--------------|---------------|---------------------|
| <b>180W</b>  | ◁ 105° x 60° | <b>9,2 kg</b> | <b>50 000 h</b>     |
| Lumens       | Teinte       | Couleur       | Code € HT           |
| <b>16200</b> | ● 3000 K     | gris          | <b>50858 598,00</b> |

## Version 250W

|              |              |               |                     |
|--------------|--------------|---------------|---------------------|
| <b>250W</b>  | ◁ 105° x 60° | <b>9,5 kg</b> | <b>50 000 h</b>     |
| Lumens       | Teinte       | Couleur       | Code € HT           |
| <b>22500</b> | ● 3000 K     | gris          | <b>50859 747,00</b> |

LAMPE

DOWNLIGHT ENCASTRE

RAIL PROJECTEUR SPOTIERIE

RÉGLLETTE

RUBAN PROFILÉ

APPLIQUE PLAFONNIER SUSPENSION

EXTÉRIEUR : PROJECTEUR

ACCESSOIRES TWISTER 3

| Désignation  | Convient pour    | Code GRIS        | € HT          | Code NOIR                 | € HT         |
|--|------------------|------------------|---------------|---------------------------|--------------|
| Tige standard long. 400 mm   | 12W - 25W - 45W  | (1) <b>50487</b> | <b>21,90</b>  | (2) <b>50076</b>          | <b>21,90</b> |
| Tige pour panneau d'exposition (épaisseur max. 40 mm) long. 400 mm   | 12W - 25W - 45W  | (3) <b>50488</b> | <b>27,30</b>  | (4) <b>50594</b>          | <b>27,30</b> |
| <b>N</b> Fixation mât simple / double Ø 60 mm  | 45W - 70W - 100W | (5) <b>50861</b> | <b>62,00</b>  | <b>N</b> (6) <b>50862</b> | <b>62,00</b> |
| Piquet de jardin   | 12W - 25W - 45W  | (7) <b>50489</b> | <b>9,90</b>   |                           |              |
| <b>N</b> Fixation mât simple / double Ø 60 mm  | 180W - 250W      | (8) <b>50863</b> | <b>97,00</b>  |                           |              |
| Rallonge pour fixation côte à côte (jusqu'à 4 proj.)<br><b>N</b> Uniquement compatible avec Projecteurs HP et la fixation <b>50863</b> | 180W - 250W      | (9) <b>50864</b> | <b>171,00</b> |                           |              |



**TWISTER 3 HIGH POWER**

Extensif



Jusqu'à  
**27 500 lm**

Corps aluminium/Verre de protection.  
Précâblage H05RN-F 3G 1 mm<sup>2</sup> long. 0,20 m, avec connecteur IP68.



**180 W**

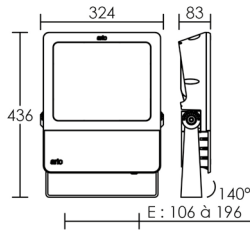

**250 W**

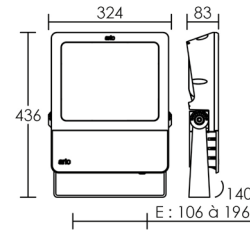

**Version 180W**

**180W 9,2 kg 50 000 h**

| Faisceau     | Lumens | Teinte | Code         | € HT          |
|--------------|--------|--------|--------------|---------------|
| <b>N</b> 15° | 19800  | 3000 K | <b>50852</b> | <b>518,00</b> |
| <b>N</b> 30° | 19800  | 3000 K | <b>50854</b> | <b>518,00</b> |
| <b>N</b> 60° | 19800  | 3000 K | <b>50856</b> | <b>518,00</b> |
| <b>N</b> 90° | 19800  | 3000 K | <b>50850</b> | <b>518,00</b> |

| 50850 | 3000K                 | 180W  | 90° |
|-------|-----------------------|-------|-----|
| h (m) | E <sub>max</sub> (lx) | d (m) |     |
| 1     | 10290                 | 2,00  |     |
| 3     | 1143                  | 4,0   |     |
| 6     | 286                   | 6,0   |     |
| 9     | 127                   | 8,0   |     |
| 12    | 71                    | 10,0  |     |

**Version 250W**

**250W 9,5 kg 50 000 h**

| Faisceau     | Lumens | Teinte | Code         | € HT          |
|--------------|--------|--------|--------------|---------------|
| <b>N</b> 15° | 27500  | 3000 K | <b>50853</b> | <b>644,00</b> |
| <b>N</b> 30° | 27500  | 3000 K | <b>50855</b> | <b>644,00</b> |
| <b>N</b> 60° | 27500  | 3000 K | <b>50857</b> | <b>644,00</b> |
| <b>N</b> 90° | 27500  | 3000 K | <b>50851</b> | <b>644,00</b> |

| 50851 | 3000K                 | 250W  | 90° |
|-------|-----------------------|-------|-----|
| h (m) | E <sub>max</sub> (lx) | d (m) |     |
| 1     | 13909                 | 2,00  |     |
| 3     | 1545                  | 4,0   |     |
| 6     | 386                   | 6,0   |     |
| 9     | 172                   | 8,0   |     |
| 12    | 97                    | 10,0  |     |



LAMPE

DOWNLIGHT  
ENCASTRE

RAIL  
PROJECTEUR  
SPOTIERIE

RÉGLLETTE

RUBAN  
PROFILÉ

APPLIQUE  
PLAFONNIER  
SUSPENSION

EXTÉRIEUR :  
PROJECTEUR



## PRINCIPE DE LA DÉTECTION

- ✓ Réglage par télécommande fournie
- ✓ Possibilité de marche forcée par interrupteur
- ✓ Possibilité d'utilisation du projecteur comme Maître dans une installation multi-appareils (jusqu'à 200W)

- ✓ Possibilité de régler la sensibilité de la détection à 50% ou 100%
- ✓ Possibilité de régler la durée d'éclairage, de 10 s à 10 min
- ✓ Possibilité d'activer et régler la détection crépusculaire de 5 à 50 lux sur 3 paliers
- ✓ Possibilité de régler la temporisation 10 s - 90 s - 3 min - 10 min

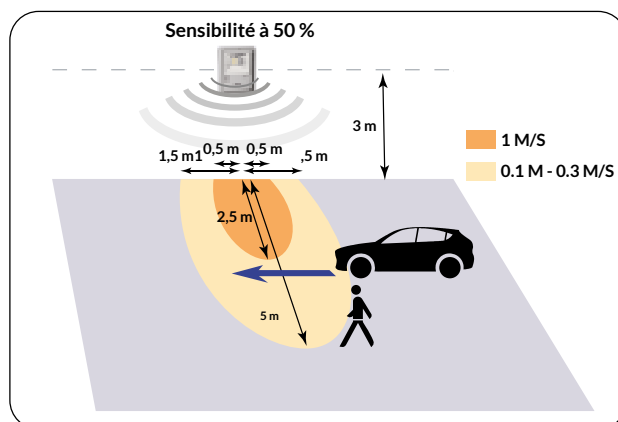
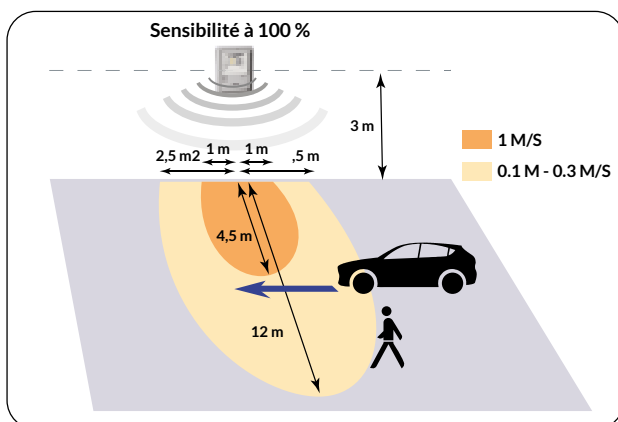

# TWISTER 3 SENSOR

Extensif



Jusqu'à  
**4950 lm**

Corps aluminium/Verre de protection. Alimentation intégrée. Précâblage H05RN-F 4G 1 mm<sup>2</sup>, long. 0,85 m.  
**Détecteur de mouvement par hyper fréquence, réglable, intégré.** Livré avec télécommande.



Repère de l'inclinaison maximale pour respecter un ULR <4% (Art 3)

**45 W**

**25 W**

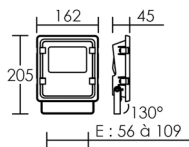

| 50875 | 3000K                 | 45W   | 90° |
|-------|-----------------------|-------|-----|
| h (m) | E <sub>max</sub> (lx) | d (m) |     |
| 1     | 2659                  | 2,0   |     |
| 2     | 665                   | 4,0   |     |
| 3     | 295                   | 6,0   |     |
| 4     | 166                   | 8,0   |     |
| 5     | 106                   | 10,0  |     |

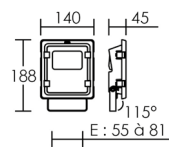

| 50874 | 3000K                 | 25W   | 90° |
|-------|-----------------------|-------|-----|
| h (m) | E <sub>max</sub> (lx) | d (m) |     |
| 1     | 1255                  | 2,0   |     |
| 2     | 314                   | 4,0   |     |
| 3     | 139                   | 6,0   |     |
| 4     | 78                    | 8,0   |     |
| 5     | 50                    | 10,0  |     |

## Version 45W

## Version 25W

| 3000 K | 90°    | 0,90 kg | 50 000 h     |
|--------|--------|---------|--------------|
| P (w)  | Lumens | Couleur | Code € HT    |
| N 45   | 4950   | gris    | 50875 127,00 |
| N 45   | 4950   | noir    | 50877 127,00 |

| 3000 K | 90°    | 0,71 kg | 50 000 h    |
|--------|--------|---------|-------------|
| P (w)  | Lumens | Couleur | Code € HT   |
| N 25   | 2500   | gris    | 50874 86,00 |
| N 25   | 2500   | noir    | 50876 86,00 |

LAMPE

DOWNLIGHT ENCASTRE

RAIL PROJECTEUR SPOTIERIE

RÉGLLETTE

RUBAN PROFILÉ

APPLIQUE PLAFONNIER SUSPENSION

EXTÉRIEUR : PROJECTEUR

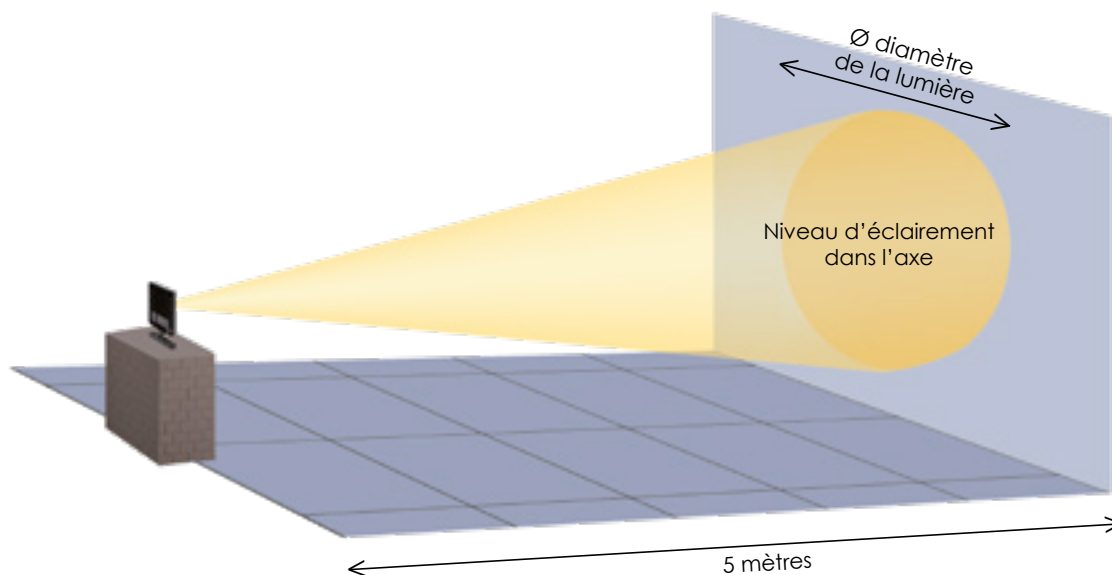

|                           | À 5 mètres de mon projecteur... | ... j'ai un aplat de lumière de diamètre : | ... pour un niveau d'éclairage dans l'axe de : |
|---------------------------|---------------------------------|--|--|
| <b>ÉCLAIRAGE INTENSIF</b> | <b>SUNSET 50 W</b>              | <b>Ø 2,2 m</b>                             | <b>403 lux</b>                                 |

|                           |                           |               |                |
|---------------------------|---------------------------|---------------|----------------|
| <b>ÉCLAIRAGE EXTENSIF</b> | <b>TWISTER 3 HP 250 W</b> | <b>Ø 10 m</b> | <b>601 lux</b> |
|                           | <b>TWISTER 3 HP 180 W</b> | <b>Ø 10 m</b> | <b>433 lux</b> |
|                           | <b>TWISTER 3 100 W</b>    | <b>Ø 10 m</b> | <b>262 lux</b> |
|                           | <b>TWISTER 3 70 W</b>     | <b>Ø 10 m</b> | <b>196 lux</b> |
|                           | <b>TWISTER 3 45 W</b>     | <b>Ø 10 m</b> | <b>109 lux</b> |
|                           | <b>TWISTER 3 25 W</b>     | <b>Ø 10 m</b> | <b>60 lux</b>  |

|                             | À 5 mètres de mon projecteur... | ... j'ai un aplat de lumière de diamètre : | ... pour un niveau d'éclairage dans l'axe de : |
|-----------------------------|---------------------------------|--|--|
| <b>ÉCLAIRAGE ELLIPTIQUE</b> | <b>SUNSET - E 50 W</b>          | <b>27,5 x 4,5 m</b>                        | <b>57 lux</b>                                  |

MICHELLE

Extensif



Jusqu'à  
**5000 lm**

Corps aluminium noir/Verre de protection. **Alimentation intégrée.**  
Précâblage H05RN-F 3G 1 mm<sup>2</sup> 0,8 m.

**Version standard**



**10 W**

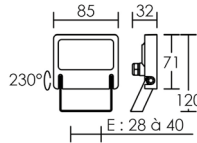

Compatible avec le piquet de jardin, code **50489**.

◀ **110°**    ○ **3000 K**    **35 000 h**

| P (W)       | Lumens | Poids (kg) | Code         | € HT         |
|-------------|--------|------------|--------------|--------------|
| <b>N</b> 10 | 950    | 0,25       | <b>50784</b> | <b>14,00</b> |

| h (m) | E <sub>max</sub> (lx) | d (m) |
|-------|-----------------------|-------|
| 1     | <b>349</b>            | 2,86  |
| 2     | <b>87</b>             | 5,7   |
| 2,5   | <b>56</b>             | 7,1   |

**Version SENSOR**



**30 W**



**50 W**

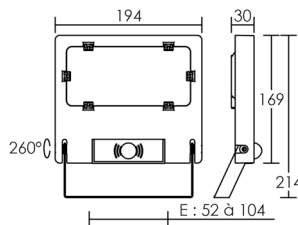
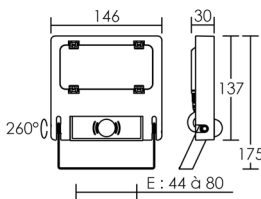

Détecteur crépusculaire infrarouge détachable et basculant. Télécommande fournie.

◀ **110°**    ○ **3000 K**    **35 000 h**

| P (W)       | Lumens | Poids (kg) | Code         | € HT          |
|-------------|--------|------------|--------------|---------------|
| <b>N</b> 30 | 3000   | 0,55       | <b>50785</b> | <b>85,00</b>  |
| <b>N</b> 50 | 5000   | 0,83       | <b>50786</b> | <b>119,00</b> |

**Mode sécurité**

- ✓ Éclairage permanent de veille
- ✓ Consommation réduite à 10 ou 30%
- ✓ En cas de détection, éclairage 100%

**TIGES COMPATIBLES**



Longueur 400 mm.

| Version   | Code         | € HT         |
|-----------|--------------|--------------|
| FA40      | <b>50076</b> | <b>21,90</b> |
| FA40 EXPO | <b>50594</b> | <b>27,30</b> |

| h (m) | E <sub>max</sub> (lx) | d (m) |
|-------|-----------------------|-------|
| 1     | <b>1218</b>           | 2,86  |
| 2     | <b>305</b>            | 5,7   |
| 2,5   | <b>195</b>            | 7,1   |

| h (m) | E <sub>max</sub> (lx) | d (m) |
|-------|-----------------------|-------|
| 1     | <b>1752</b>           | 2,86  |
| 2     | <b>438</b>            | 5,7   |
| 2,5   | <b>280</b>            | 7,1   |

SUNSET

Intensif



4000 lm

Corps aluminium/Verre de protection. Alimentation intégrée. Précâblage 1,5 m. Optique symétrique.

Version blanche



| 50W      |        | 2,3 kg   |              | 30 000 h      |  |
|----------|--------|----------|--------------|---------------|--|
| Faisceau | Lumens | Teinte   | Code         | € HT          |  |
| 25°      | 4000   | ● 3000 K | <b>50281</b> | <b>199,90</b> |  |
| 25°      | 4000   | ○ 4000 K | <b>50279</b> | <b>199,90</b> |  |
| 50°      | 4000   | ● 3000 K | <b>50247</b> | <b>199,90</b> |  |
| 50°      | 4000   | ○ 4000 K | <b>50242</b> | <b>199,90</b> |  |

Version noire



| 50W      |        | 2,3 kg   |              | 30 000 h      |  |
|----------|--------|----------|--------------|---------------|--|
| Faisceau | Lumens | Teinte   | Code         | € HT          |  |
| 25°      | 4000   | ● 3000 K | <b>50282</b> | <b>199,90</b> |  |
| 25°      | 4000   | ○ 4000 K | <b>50280</b> | <b>199,90</b> |  |
| 50°      | 4000   | ● 3000 K | <b>50248</b> | <b>199,90</b> |  |
| 50°      | 4000   | ○ 4000 K | <b>50243</b> | <b>199,90</b> |  |

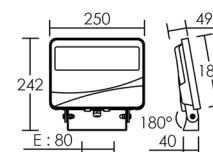

TIGES COMPATIBLES



Pour SUNSET, longueur 400 mm.

| Couleur | Code        | € HT         |
|---------|-------------|--------------|
| blanc   | <b>1637</b> | <b>29,80</b> |
| noir    | <b>1636</b> | <b>29,80</b> |

| SUNSET 3000K | 50W                   | 25°   |
|--------------|-----------------------|-------|
| h (m)        | E <sub>max</sub> (lx) | d (m) |
| 1            | 11505                 | 0,44  |
| 3            | 1278                  | 1,3   |
| 5            | 460                   | 2,2   |
| 6            | 320                   | 2,7   |
| 7            | 235                   | 3,1   |

| SUNSET 4000K | 50W                   | 25°   |
|--------------|-----------------------|-------|
| h (m)        | E <sub>max</sub> (lx) | d (m) |
| 1            | 11505                 | 0,44  |
| 3            | 1278                  | 1,3   |
| 5            | 460                   | 2,2   |
| 6            | 320                   | 2,7   |
| 7            | 235                   | 3,1   |

| SUNSET 3000K | 50W                   | 50°   |
|--------------|-----------------------|-------|
| h (m)        | E <sub>max</sub> (lx) | d (m) |
| 1            | 4303                  | 0,93  |
| 3            | 478                   | 2,8   |
| 5            | 172                   | 4,7   |
| 6            | 120                   | 5,6   |
| 7            | 88                    | 6,5   |

| SUNSET 4000K | 50W                   | 50°   |
|--------------|-----------------------|-------|
| h (m)        | E <sub>max</sub> (lx) | d (m) |
| 1            | 4303                  | 0,93  |
| 3            | 478                   | 2,8   |
| 5            | 172                   | 4,7   |
| 6            | 120                   | 5,6   |
| 7            | 88                    | 6,5   |

SUNSET-E

Elliptique



4000 lm

Corps aluminium/Verre de protection. Alimentation intégrée. Précâblage 1,5 m. Optique elliptique.

Version blanche



50W 2,3 kg 30 000 h

| Faisceau   | Lumens | Teinte | Code  | € HT   |
|------------|--------|--------|-------|--------|
| 140° x 50° | 4000   | 3000 K | 50302 | 199,90 |
| 140° x 50° | 4000   | 4000 K | 50303 | 199,90 |

Version noire



50W 2,3 kg 30 000 h

| Faisceau   | Lumens | Teinte | Code  | € HT   |
|------------|--------|--------|-------|--------|
| 140° x 50° | 4000   | 3000 K | 50304 | 199,90 |
| 140° x 50° | 4000   | 4000 K | 50305 | 199,90 |

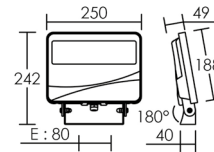

L'optique elliptique permet, tout en conservant une bonne homogénéité au sol, l'installation de moins d'appareils d'éclairage.

TIGES COMPATIBLES



Pour SUNSET, longueur 400 mm.

| Couleur | Code | € HT  |
|---------|------|-------|
| blanc   | 1637 | 29,80 |
| noir    | 1636 | 29,80 |

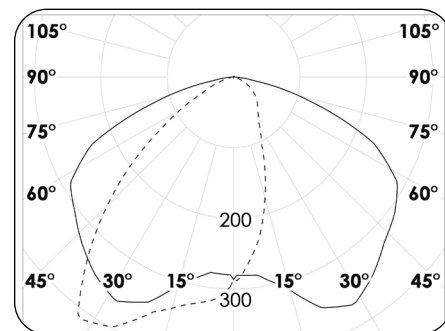

CD/klm  
C0 - C180 --- C90 - C270  $\eta = 98\%$



Jusqu'à  
4750 lm



50 W

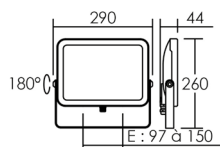

| WINK  | 3000K                       | 50W          | 110° |
|-------|-----------------------------|--------------|------|
| h (m) | <b>E<sub>max</sub> (lx)</b> | <b>d (m)</b> |      |
| 1     | <b>1776</b>                 | 2,86         |      |
| 2     | <b>444</b>                  | 5,7          |      |
| 2,5   | <b>284</b>                  | 7,1          |      |
| 4     | <b>111</b>                  | 11,4         |      |
| 5     | <b>71</b>                   | 14,3         |      |

| WINK  | 4000K                       | 50W          | 110° |
|-------|-----------------------------|--------------|------|
| h (m) | <b>E<sub>max</sub> (lx)</b> | <b>d (m)</b> |      |
| 1     | <b>1724</b>                 | 2,86         |      |
| 2     | <b>431</b>                  | 5,7          |      |
| 2,5   | <b>276</b>                  | 7,1          |      |
| 4     | <b>108</b>                  | 11,4         |      |
| 5     | <b>69</b>                   | 14,3         |      |



30 W

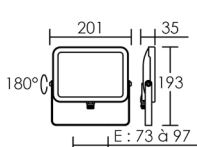

| WINK  | 3000K                       | 30W          | 110° |
|-------|-----------------------------|--------------|------|
| h (m) | <b>E<sub>max</sub> (lx)</b> | <b>d (m)</b> |      |
| 1     | <b>975</b>                  | 2,86         |      |
| 2     | <b>244</b>                  | 5,7          |      |
| 2,5   | <b>156</b>                  | 7,1          |      |
| 4     | <b>61</b>                   | 11,4         |      |
| 5     | <b>39</b>                   | 14,3         |      |

| WINK  | 4000K                       | 30W          | 110° |
|-------|-----------------------------|--------------|------|
| h (m) | <b>E<sub>max</sub> (lx)</b> | <b>d (m)</b> |      |
| 1     | <b>1028</b>                 | 2,86         |      |
| 2     | <b>257</b>                  | 5,7          |      |
| 2,5   | <b>164</b>                  | 7,1          |      |
| 4     | <b>64</b>                   | 11,4         |      |
| 5     | <b>41</b>                   | 14,3         |      |



20 W

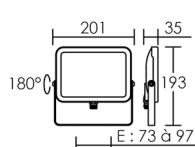

| WINK  | 3000K                       | 20W          | 110° |
|-------|-----------------------------|--------------|------|
| h (m) | <b>E<sub>max</sub> (lx)</b> | <b>d (m)</b> |      |
| 1     | <b>709</b>                  | 2,9          |      |
| 2     | <b>177</b>                  | 5,7          |      |
| 2,5   | <b>113</b>                  | 7,1          |      |

| WINK  | 4000K                       | 20W          | 110° |
|-------|-----------------------------|--------------|------|
| h (m) | <b>E<sub>max</sub> (lx)</b> | <b>d (m)</b> |      |
| 1     | <b>743</b>                  | 2,86         |      |
| 2     | <b>186</b>                  | 5,7          |      |
| 3     | <b>83</b>                   | 8,6          |      |



10 W

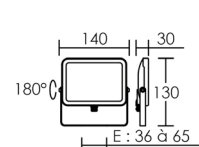

| WINK  | 3000K                       | 10W          | 110° |
|-------|-----------------------------|--------------|------|
| h (m) | <b>E<sub>max</sub> (lx)</b> | <b>d (m)</b> |      |
| 1     | <b>384</b>                  | 2,9          |      |
| 2     | <b>96</b>                   | 5,7          |      |
| 2,5   | <b>61</b>                   | 7,1          |      |

| WINK  | 4000K                       | 10W          | 110° |
|-------|-----------------------------|--------------|------|
| h (m) | <b>E<sub>max</sub> (lx)</b> | <b>d (m)</b> |      |
| 1     | <b>397</b>                  | 2,9          |      |
| 2     | <b>99</b>                   | 5,7          |      |
| 2,5   | <b>64</b>                   | 7,1          |      |

TIGES COMPATIBLES



Pour les WINK 10W, 20W et 30W.  
Longueur 400 mm.

| Couleur | Code         | € HT         |
|---------|--------------|--------------|
| blanc   | <b>50149</b> | <b>21,90</b> |
| noir    | <b>50076</b> | <b>21,90</b> |

Corps aluminium/Verre de protection. **Alimentation intégrée.** Précâblage H05RN-F 3G 1 mm<sup>2</sup> long. 0,8 m.

| ◁ 110°   |        |            |              |              | 30 000 h     |              |
|----------|--------|------------|--------------|--------------|--------------|--------------|
| P (w)    | Lumens | Poids (kg) | Code BLANC   | € HT         | Code NOIR    | € HT         |
| ● 3000 K |        |            |              |              |              |              |
| 10       | 900    | 0,43       | <b>50385</b> | <b>31,60</b> | <b>50504</b> | <b>31,60</b> |
| 20       | 1800   | 0,86       | <b>50386</b> | <b>44,90</b> | <b>50505</b> | <b>44,90</b> |
| 30       | 2450   | 0,87       | <b>50387</b> | <b>59,20</b> | <b>50506</b> | <b>59,20</b> |
| 50       | 4500   | 1,75       | <b>50388</b> | <b>90,80</b> | <b>50507</b> | <b>90,80</b> |
| ○ 4000 K |        |            |              |              |              |              |
| 10       | 950    | 0,43       | <b>50389</b> | <b>31,60</b> | <b>50493</b> | <b>31,60</b> |
| 20       | 1900   | 0,86       | <b>50390</b> | <b>44,90</b> | <b>50494</b> | <b>44,90</b> |
| 30       | 2600   | 0,87       | <b>50391</b> | <b>59,20</b> | <b>50495</b> | <b>59,20</b> |
| 50       | 4750   | 1,75       | <b>50392</b> | <b>90,80</b> | <b>50496</b> | <b>90,80</b> |



WINK SENSOR

Extensif



Jusqu'à  
1900 lm

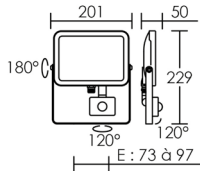

20 W

| 50816 | 3000K                 | 20W   | 110° |
|-------|-----------------------|-------|------|
| h (m) | E <sub>max</sub> (lx) | d (m) |      |
| 1     | 626                   | 2,86  |      |
| 2     | 157                   | 5,7   |      |
| 3     | 70                    | 8,6   |      |

| WINK  | 4000K                 | 20 W  | 110° |
|-------|-----------------------|-------|------|
| h (m) | E <sub>max</sub> (lx) | d (m) |      |
| 1     | 743                   | 2,86  |      |
| 2     | 186                   | 5,7   |      |
| 3     | 83                    | 8,6   |      |

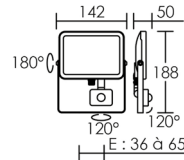

10 W

| 50815 | 3000K                 | 10W   | 110° |
|-------|-----------------------|-------|------|
| h (m) | E <sub>max</sub> (lx) | d (m) |      |
| 1     | 342                   | 2,86  |      |
| 2     | 86                    | 5,7   |      |
| 3     | 38                    | 8,6   |      |

| WINK  | 4000K                 | 10W   | 110° |
|-------|-----------------------|-------|------|
| h (m) | E <sub>max</sub> (lx) | d (m) |      |
| 1     | 397                   | 2,9   |      |
| 2     | 99                    | 5,7   |      |
| 2,5   | 64                    | 7,1   |      |



TIGE COMPATIBLE



Pour les WINK SENSOR.  
Longueur 400 mm.

| Couleur | Code  | € HT  |
|---------|-------|-------|
| blanc   | 50149 | 21,90 |

Corps aluminium blanc/Verre de protection.  
**Alimentation intégrée.** Précâblage H05RN-F 3G 1 mm<sup>2</sup> long. 0,8 m. **Détecteur de mouvement infra-rouge réglable intégré.**

| ◀ 110°        |        | 30 000 h   |              |              |
|---------------|--------|------------|--------------|--------------|
| P (w)         | Lumens | Poids (kg) | Code         | € HT         |
| <b>3000 K</b> |        |            |              |              |
| <b>N</b> 10   | 900    | 0,5        | <b>50815</b> | <b>60,20</b> |
| <b>N</b> 20   | 1800   | 0,9        | <b>50816</b> | <b>77,50</b> |
| <b>4000 K</b> |        |            |              |              |
| 10            | 950    | 0,5        | <b>50398</b> | <b>60,20</b> |
| 20            | 1900   | 0,9        | <b>50399</b> | <b>77,50</b> |

LAMPE

DOWNLIGHT  
ENCASTRÉ

RAIL  
PROJECTEUR  
SPOTIERE

RÉGLIETTE

RUBAN  
PROFILÉ

APPLIQUE  
PLAFONNIER  
SUSPENSION

EXTÉRIEUR :  
PROJECTEUR



1000 lm



**+** Pratique

- ✓ Corps thermoplastique résistant à la corrosion
- ✓ EXTRA-PLAT Seulement 43 mm



Corps thermoplastique/Diffuseur polycarbonate. Précâblage H05RN-F 3G 1 mm<sup>2</sup> 1 m.

◁ 60° 25 000 h

| P (w) | Lumens | Teinte   | Code         | € HT         |
|-------|--------|----------|--------------|--------------|
| 10    | 1000   | ○ 4000 K | <b>50230</b> | <b>28,60</b> |

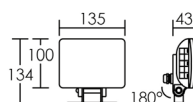

| ELFI | 4000 K | 10 W                  | 60°   |
|------|--------|-----------------------|-------|
|      | h (m)  | E <sub>max</sub> (lx) | d (m) |
|      | 1      | <b>1088</b>           | 1,15  |
|      | 2      | <b>272</b>            | 2,3   |
|      | 3      | <b>121</b>            | 3,5   |

**ACCESSOIRES ELFI**

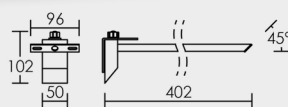

Tiges pour ELFI vendues séparément.

| L (mm) | Couleur | Code         | € HT         |
|--------|---------|--------------|--------------|
| 400    | blanc   | <b>50149</b> | <b>21,90</b> |

Tiges FA 40 EXPO. Support et tige acier. Convient pour panneaux de 3 mm à 40 mm.

| L (mm) | Couleur | Code         | € HT         |
|--------|---------|--------------|--------------|
| 400    | blanc   | <b>50451</b> | <b>27,30</b> |

ZODIAK

Extensif



Jusqu'à  
**1600 lm**

Corps aluminium/Verre de protection dépoli. Précâblage H05RN-F 3G 1 mm<sup>2</sup> 0,4 m.



**20 W**

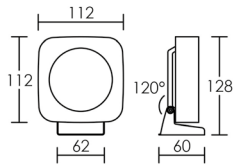

| 50500 | 4000 K                | 20 W  | 100° |
|-------|-----------------------|-------|------|
| h (m) | E <sub>max</sub> (lx) | d (m) |      |
| 1     | <b>705</b>            | 2,38  |      |
| 2     | <b>176</b>            | 4,8   |      |
| 3     | <b>78</b>             | 7,2   |      |

| 50501 | 3000 K                | 20 W  | 100° |
|-------|-----------------------|-------|------|
| h (m) | E <sub>max</sub> (lx) | d (m) |      |
| 1     | <b>705</b>            | 2,38  |      |
| 2     | <b>176</b>            | 4,8   |      |
| 3     | <b>78</b>             | 7,2   |      |



**10 W**

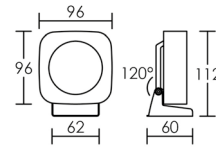

| 50498 | 3000 K                | 10 W  | 100° |
|-------|-----------------------|-------|------|
| h (m) | E <sub>max</sub> (lx) | d (m) |      |
| 1     | <b>389</b>            | 2,38  |      |
| 2     | <b>97</b>             | 4,8   |      |
| 3     | <b>43</b>             | 7,2   |      |

| 50393 | 4000 K                | 10 W  | 100° |
|-------|-----------------------|-------|------|
| h (m) | E <sub>max</sub> (lx) | d (m) |      |
| 1     | <b>389</b>            | 2,38  |      |
| 2     | <b>97</b>             | 4,8   |      |
| 2,5   | <b>62</b>             | 6,0   |      |

**Version 20W**

| ◀ 100° |        |         |              |              | 30 000 h |
|--------|--------|---------|--------------|--------------|----------|
| Lumens | Teinte | Couleur | Code         | € HT         |          |
| 1600   | 3000 K | blanc   | <b>50501</b> | <b>38,80</b> |          |
| 1600   | 4000 K | blanc   | <b>50500</b> | <b>38,80</b> |          |
| 1600   | 3000 K | noir    | <b>50503</b> | <b>38,80</b> |          |
| 1600   | 4000 K | noir    | <b>50502</b> | <b>38,80</b> |          |

Dimmable sur variateur universel.

**Version 10W**

| ◀ 100° |        |         |              |              | 30 000 h |
|--------|--------|---------|--------------|--------------|----------|
| Lumens | Teinte | Couleur | Code         | € HT         |          |
| 850    | 3000 K | blanc   | <b>50498</b> | <b>24,50</b> |          |
| 850    | 4000 K | blanc   | <b>50393</b> | <b>24,50</b> |          |
| 850    | 3000 K | noir    | <b>50499</b> | <b>24,50</b> |          |
| 850    | 4000 K | noir    | <b>50497</b> | <b>24,50</b> |          |

Dimmable sur variateur universel.

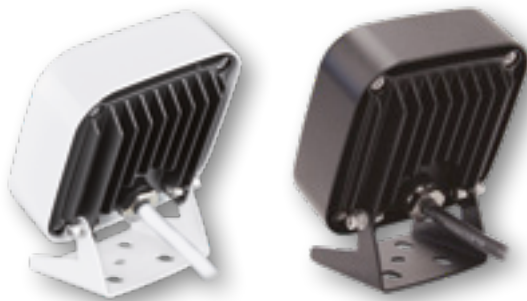

LAMPE

DOWNLIGHT  
ENCASTRE

RAIL  
PROJECTEUR  
SPOTERIE

RÉGLLETTE

RUBAN  
PROFILÉ

APPLIQUE  
PLAFONNIER  
SUSPENSION

EXTÉRIEUR :  
PROJECTEUR

**TAG**

Extensif



2900 lm



Corps aluminium/Peinture Epoxy/Diffuseur polycarbonate.

30W ◁ 150° x 60° 50 000 h

| Lumens | Teinte   | Couleur | Code         | € HT          |
|--------|----------|---------|--------------|---------------|
| 2700   | ● 3000 K | blanc   | <b>50685</b> | <b>149,90</b> |
| 2700   | ● 3000 K | noir    | <b>50686</b> | <b>149,90</b> |
| 2900   | ○ 4000 K | blanc   | <b>50351</b> | <b>149,90</b> |
| 2900   | ○ 4000 K | noir    | <b>50352</b> | <b>149,90</b> |

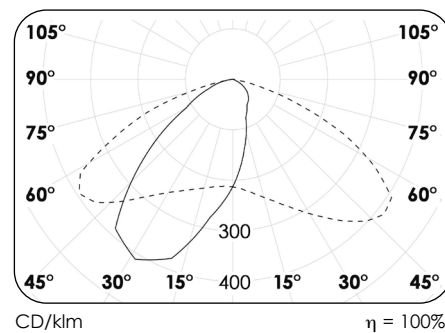

**ACCESSOIRES TAG**

**TIGE FA 57**



Tiges pour TAG vendues séparément. Support mural aluminium permettant d'éloigner le projecteur pour l'éclairage des vitrines. Protection anti-corrosion.

| Couleur        | Code        | € HT         |
|----------------|-------------|--------------|
| <b>N</b> blanc | <b>3144</b> | <b>29,60</b> |
| <b>N</b> noir  | <b>3145</b> | <b>29,60</b> |

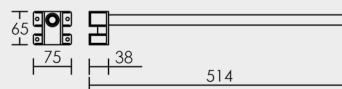

**PATÈRE 01**



| Couleur | Code        | € HT         |
|---------|-------------|--------------|
| blanc   | <b>0196</b> | <b>19,00</b> |
| noir    | <b>0197</b> | <b>19,00</b> |

DIA

Extensif



2350 lm

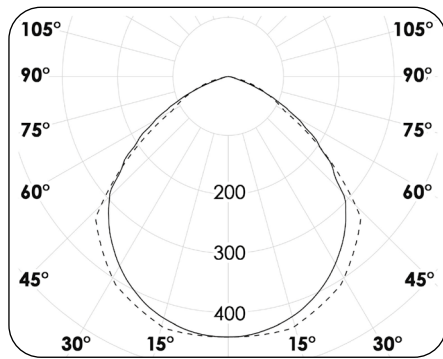
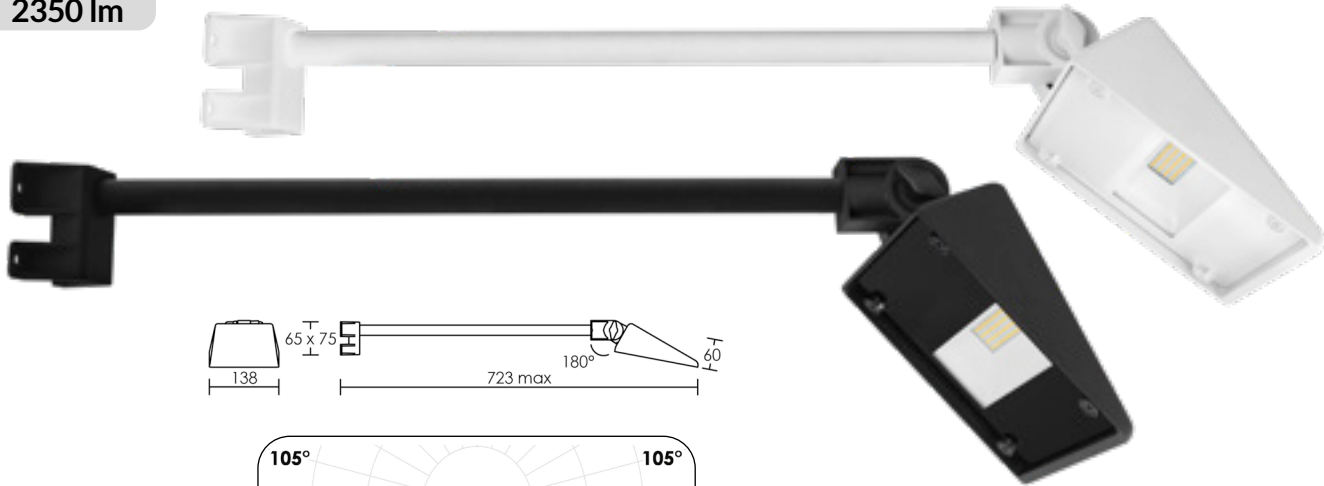

CD/klm  
C0 - C180 --- C90 - C270  
 $\eta = 100\%$

Corps aluminium. Tige de fixation aluminium déportée fournie.

18W  $\triangleleft 90^\circ \times 105^\circ$  35 000 h

| Lumens | Teinte | Couleur | Code  | € HT   |
|--------|--------|---------|-------|--------|
| 2350   | 3000 K | blanc   | 50810 | 119,00 |
| 2350   | 3000 K | noir    | 50811 | 119,00 |



## Aide à la pose - Gamme TAG / DIA

### Cas d'une installation sur tige

✓ Pour 300 à 500 lux moyens sur l'enseigne et une bonne homogénéité

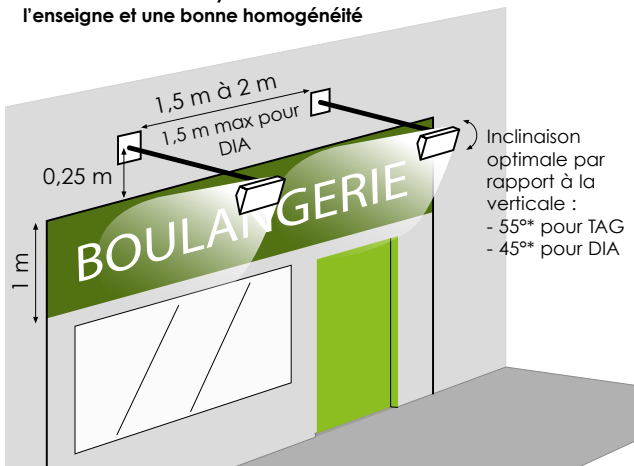

\*0° : le plateau de LED est parallèle à l'enseigne

### Cas d'une installation sur patère

✓ Pour des accentuations > 2000 lux

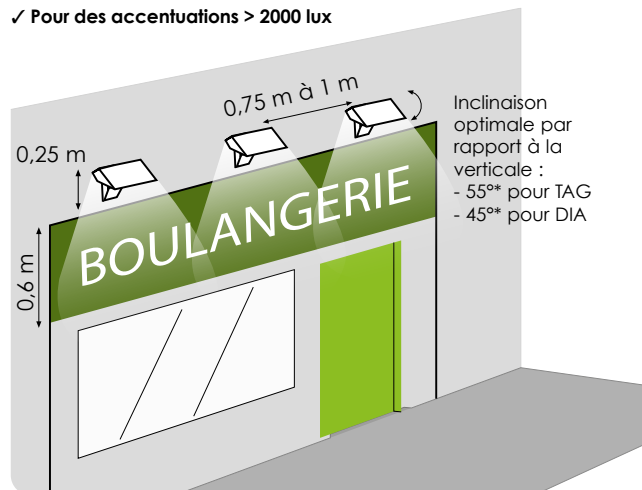

LAMPE

DOWNLIGHT ENCASTRE

RAIL PROJECTEUR SPOTIERE

RÉGLLETTE

RUBAN PROFILÉ

APPLIQUE PLAFONNIER SUSPENSION

EXTÉRIEUR : PROJECTEUR

ZURO LED

Intensif



Jusqu'à  
**2800 lm**

Corps aluminium/Diffuseur polycarbonate transparent. Jeu de fixation et éclisse inclus. Alimentation intégrée.  
**Montage uniquement éclairage vers le bas.** Eclisse d'alignement. Connecteurs étanches pour repiquage, jeux de fixations courtes fournies.



Version 34W

| 34W      |              | L = 1223 mm |      | 30 000 h |  |
|----------|--------------|-------------|------|----------|--|
| Lumens   | Couleur      | Couleur     | Code | € HT     |  |
| ○ 3000 K |              |             |      |          |  |
| N 2660   | beige        | 1013        | 5488 | 489,00   |  |
| N 2660   | gris         | 9006        | 5489 | 489,00   |  |
| N 2660   | blanc        | 9003        | 5490 | 489,00   |  |
| N 2660   | noir         | 9005        | 5491 | 489,00   |  |
| N 2660   | gris foncé   | 7016        | 5492 | 489,00   |  |
| N 2660   | RAL au choix |             | 5493 | 513,00   |  |
| ○ 4000 K |              |             |      |          |  |
| 2800     | beige        | 1013        | 5372 | 489,00   |  |
| 2800     | gris         | 9006        | 5373 | 489,00   |  |
| 2800     | blanc        | 9003        | 5467 | 489,00   |  |
| 2800     | noir         | 9005        | 5468 | 489,00   |  |
| 2800     | gris foncé   | 7016        | 5469 | 489,00   |  |
| 2800     | RAL au choix |             | 5377 | 513,00   |  |

Version 18W

| 18W      |              | L = 623 mm |      | 30 000 h |  |
|----------|--------------|------------|------|----------|--|
| Lumens   | Couleur      | RAL        | Code | € HT     |  |
| ○ 3000 K |              |            |      |          |  |
| N 1330   | beige        | 1013       | 5475 | 386,00   |  |
| N 1330   | gris         | 9006       | 5476 | 386,00   |  |
| N 1330   | blanc        | 9003       | 5477 | 386,00   |  |
| N 1330   | noir         | 9005       | 5478 | 386,00   |  |
| N 1330   | gris foncé   | 7016       | 5479 | 386,00   |  |
| N 1330   | RAL au choix |            | 5480 | 406,00   |  |
| ○ 4000 K |              |            |      |          |  |
| 1400     | beige        | 1013       | 5370 | 386,00   |  |
| 1400     | gris         | 9006       | 5371 | 386,00   |  |
| 1400     | blanc        | 9003       | 5464 | 386,00   |  |
| 1400     | noir         | 9005       | 5465 | 386,00   |  |
| 1400     | gris foncé   | 7016       | 5466 | 386,00   |  |
| 1400     | RAL au choix |            | 5376 | 406,00   |  |



Exemples de nos réalisations (Paris 1<sup>er</sup> - Annecy)

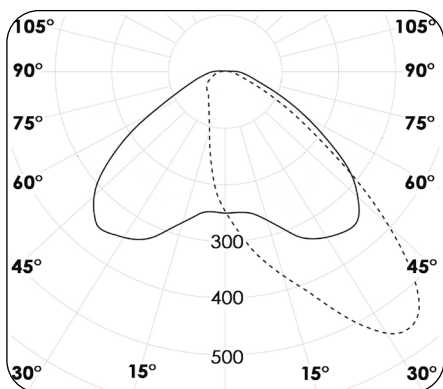

CD/klm  $\eta = 100\%$   
 C0 - C180 --- C90 - C270

**+** **Un ZURO**  
à vos couleurs

Nous réalisons sur commande le produit au RAL de votre choix.

Forfait de mise en peinture :  
 <10 pièces, code 1925, 306 €  
 >10 pièces, code 1994, 204 €

### ACCESSOIRES ZURO

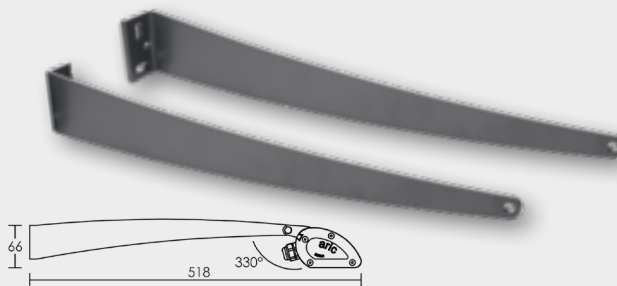

#### FIXATION DÉPORTÉE

Permet d'éloigner le bandeau du mur de fixation à 400 mm.  
**A commander séparément.**

| Couleur      | RAL  | Code | € HT  |
|--------------|------|------|-------|
| beige        | 1013 | 0971 | 75,30 |
| gris         | 9006 | 0941 | 75,30 |
| blanc        | 9003 | 1169 | 75,30 |
| noir         | 9005 | 1191 | 75,30 |
| gris foncé   | 7016 | 1196 | 75,30 |
| RAL au choix |      | 1309 | 85,90 |

LAMPE

DOWNLIGHT  
ENCASTRE

RAIL  
PROJECTEUR  
SPOTIERIE

RÉGLLETTE

RUBAN  
PROFILÉ

APPLIQUE  
PLAFONNIER  
SUSPENSION

EXTÉRIEUR :  
PROJECTEUR

## MX 1500

Intensif

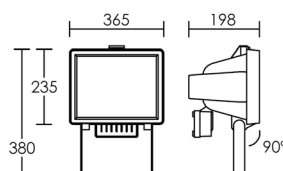

Corps aluminium/Réflecteur aluminium/Boîte de raccordement thermoplastique/Verre trempé de protection.

| P (w) | Douille    | Couleur | Code sans lampe | € HT          |
|-------|------------|---------|-----------------|---------------|
| 1500  | R7s 254 mm | noir    | <b>0593</b>     | <b>128,80</b> |

| MX 1500 | 3000 K                | 1500 W | 65° |
|---------|-----------------------|--------|-----|
| h (m)   | E <sub>max</sub> (lx) | d (m)  |     |
| 1       | <b>15489</b>          | 1,3    |     |
| 3       | <b>1721</b>           | 3,8    |     |
| 5       | <b>620</b>            | 6,4    |     |
| 7       | <b>316</b>            | 8,9    |     |
| 10      | <b>155</b>            | 12,7   |     |

## MX 1000

Intensif

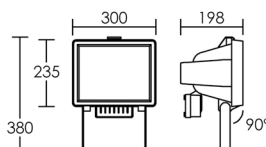

Corps aluminium/Réflecteur aluminium/Boîte de raccordement thermoplastique/Verre trempé de protection.

| P (w) | Douille    | Couleur | Code sans lampe | € HT          |
|-------|------------|---------|-----------------|---------------|
| 1000  | R7s 189 mm | noir    | <b>0592</b>     | <b>111,70</b> |

| MX 1000 | 3000 K                | 1000 W | 65° |
|---------|-----------------------|--------|-----|
| h (m)   | E <sub>max</sub> (lx) | d (m)  |     |
| 1       | <b>9387</b>           | 1,3    |     |
| 3       | <b>1043</b>           | 3,8    |     |
| 5       | <b>375</b>            | 6,4    |     |
| 6       | <b>261</b>            | 7,6    |     |
| 7       | <b>192</b>            | 8,9    |     |

### ACCESSOIRES Gamme MX

| Référence      | Dim. verre (mm) | Code verre  | € HT         | Code grille | € HT         |
|----------------|-----------------|-------------|--------------|-------------|--------------|
| <b>MX 1000</b> | 22 x 29         | <b>1668</b> | <b>19,10</b> | <b>1665</b> | <b>43,50</b> |
| <b>MX 1500</b> | 22 x 35         | <b>1669</b> | <b>22,90</b> | <b>1666</b> | <b>65,50</b> |



ZENITH

Intensif

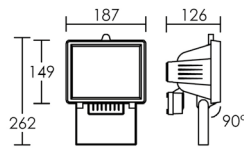

Corps aluminium noir/Réflecteur aluminium/Boîte de raccordement thermoplastique.

| P (w) | Douille    | Couleur | Code sans lampe | € HT         |
|-------|------------|---------|-----------------|--------------|
| 500   | R7s 118 mm | noir    | <b>0563</b>     | <b>24,00</b> |

| Code : | 0573        | 400 w | 65° |
|--------|-------------|-------|-----|
| h (m)  | E (lx)      | d (m) |     |
| 1      | <b>1700</b> | 1,3   |     |
| 3      | <b>189</b>  | 3,8   |     |
| 5      | <b>68</b>   | 6,4   |     |

JUNIOR

Intensif

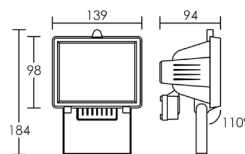

Corps aluminium/Réflecteur aluminium/Boîte de raccordement thermoplastique/Verre de protection trempé.

| P (w) | Douille   | Couleur | Code sans lampe | € HT         |
|-------|-----------|---------|-----------------|--------------|
| 120   | R7s 78 mm | noir    | <b>0574</b>     | <b>18,20</b> |
| 120   | R7s 78 mm | blanc   | <b>0576</b>     | <b>18,20</b> |

| Code : | 0574       | 120 w | 40° |
|--------|------------|-------|-----|
| h (m)  | E (lx)     | d (m) |     |
| 1      | <b>615</b> | 0,7   |     |
| 2      | <b>154</b> | 1,4   |     |
| 3      | <b>68</b>  | 2,1   |     |

LAMPE

DOWNLIGHT ENCASTRE

RAIL PROJECTEUR SPOTERIE

RÉGLIETTE

RUBAN PROFILÉ

APPLIQUE PLAFONNIER SUSPENSION

EXTÉRIEUR : PROJECTEUR

**KIT DAFNEE LED**

Intensif



1350 lm

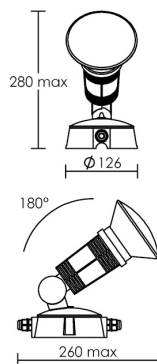

Corps thermoplastique noir. Fixation murale. **Piquet de jardin inclus.** 2 presse-étoupes Ø9 mm.

**E27** **35 000 h**

| P (w) | Lumens | Teinte   | Code avec lampe | € HT         |
|-------|--------|----------|-----------------|--------------|
| 15    | 1350   | ● 3000 K | <b>50100</b>    | <b>67,00</b> |
| 15    | 1350   | ○ 4000 K | <b>50097</b>    | <b>67,00</b> |

| PAR 38 LED | 3000 K                | 15 W  | 30° |
|------------|-----------------------|-------|-----|
| h (m)      | E <sub>max</sub> (lx) | d (m) |     |
| 1          | <b>2172</b>           | 0,54  |     |
| 2          | <b>543</b>            | 1,1   |     |
| 3          | <b>241</b>            | 1,6   |     |
| 4          | <b>136</b>            | 2,1   |     |
| 5          | <b>87</b>             | 2,7   |     |

| PAR 38 LED | 4000 K                | 15 W  | 30° |
|------------|-----------------------|-------|-----|
| h (m)      | E <sub>max</sub> (lx) | d (m) |     |
| 1          | <b>2172</b>           | 0,54  |     |
| 2          | <b>543</b>            | 1,1   |     |
| 3          | <b>241</b>            | 1,6   |     |
| 4          | <b>136</b>            | 2,1   |     |
| 5          | <b>87</b>             | 2,7   |     |

**DAFNEE**

Intensif

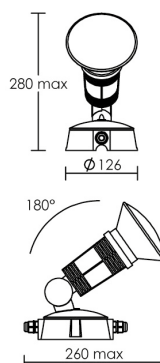

Corps thermoplastique. Fixation murale. **Piquet de jardin inclus.** 2 presse-étoupes Ø9 mm.

| P (w) | Douille | Couleur | Code sans lampe | € HT         |
|-------|---------|---------|-----------------|--------------|
| 100   | E27     | noir    | <b>0790</b>     | <b>40,90</b> |

Joint de rechange, code **0836**.

**ELFI**

Intensif



1000 lm

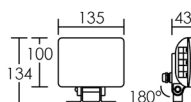

Corps thermoplastique/Diffuseur polycarbonate. Extra-plat : seulement 43 mm. Précâblage H05RN-F 3G 1 mm<sup>2</sup> 1 m.

**60°** **25 000 h**

| P (w) | Lumens | Teinte   | Code         | € HT         |
|-------|--------|----------|--------------|--------------|
| 10    | 1000   | ○ 4000 K | <b>50230</b> | <b>28,60</b> |

| ELFI  | 4000 K                | 10 W  | 60° |
|-------|-----------------------|-------|-----|
| h (m) | E <sub>max</sub> (lx) | d (m) |     |
| 1     | <b>1088</b>           | 1,15  |     |
| 2     | <b>272</b>            | 2,3   |     |
| 3     | <b>121</b>            | 3,5   |     |

Corps thermoplastique = résistance à la corrosion

TOPAZE

Intensif



1000 lm

Corps en aluminium graphite/Verre de protection transparent. Précâblage H05RN-F 3G1 mm<sup>2</sup>, long. 0,25 m. Piquet de jardin fourni.

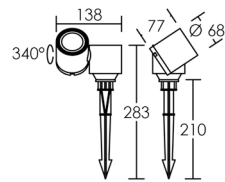

Version 1 tête

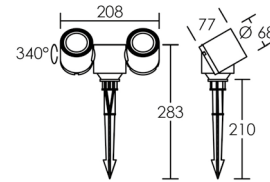

Version 2 têtes

◀ 36° GU10 15 000 h

| P (w)      | Lumens | Teinte | Code  | € HT  |
|------------|--------|--------|-------|-------|
| <b>N</b> 6 | 500    | 3000 K | 50914 | 42,00 |

Données de la lampe.

◀ 36° GU10 15 000 h

| P (w)         | Lumens | Teinte | Code  | € HT  |
|---------------|--------|--------|-------|-------|
| <b>N</b> 2x 6 | 2x 500 | 3000 K | 50915 | 49,00 |

Données de la lampe.



LAMPE

DOWNLIGHT ENCASTRE

RAIL PROJECTEUR SPOTERIE

RÉGLLETTE

RUBAN PROFILÉ

APPLIQUE PLAFONNIER SUSPENSION

EXTÉRIEUR : PROJECTEUR

**KIT ASTER**

Intensif



500 lm

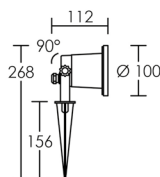

Corps aluminium noir/Équerre acier noir. Verre de protection. Câble H05RN-F 1 m. **Piquet de jardin inclus.**

36° GU10 15 000 h

| P (w) | Lumens | Teinte | Code avec lampe | € HT  |
|-------|--------|--------|-----------------|-------|
| 6     | 470    | 3000 K | 50205           | 52,00 |
| 6     | 500    | 4000 K | 50206           | 52,00 |

Données de la lampe.

| LED 6E | 3000K                 | 6W    | 36° |
|--------|-----------------------|-------|-----|
| h (m)  | E <sub>max</sub> (lx) | d (m) |     |
| 1      | 972                   | 0,65  |     |
| 2      | 243                   | 1,3   |     |
| 2,5    | 156                   | 1,6   |     |

| LED 6E | 4000K                 | 6W    | 36° |
|--------|-----------------------|-------|-----|
| h (m)  | E <sub>max</sub> (lx) | d (m) |     |
| 1      | 1035                  | 0,65  |     |
| 2      | 259                   | 1,3   |     |
| 2,5    | 166                   | 1,6   |     |

**SUKO**

Intensif



170 lm

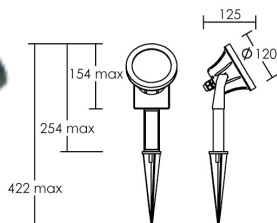

Corps thermoplastique noir. Alimentation 50 Hz intégrée. Câble H05RN-F 2 m - fiche 2 P+T, 16A IP44. **Uniquement pour piscine intérieure. Piquet de jardin inclus.**

15 000 h

| P (w) | Lumens | Teinte      | Code | € HT  |
|-------|--------|-------------|------|-------|
| 5,5   | 170    | blanc froid | 0300 | 80,00 |

| 0300  | B. FROID              | 5,5 W | 17° |
|-------|-----------------------|-------|-----|
| h (m) | E <sub>max</sub> (lx) | d (m) |     |
| 1     | 894                   | 0,30  |     |
| 2     | 224                   | 0,6   |     |
| 3     | 99                    | 0,9   |     |

**TELO LED**

Intensif



240 lm

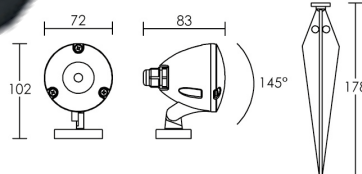

Corps thermoplastique noir/Ecran polycarbonate. Câble H05RN-F 2 m - fiche 16A, IP44. Presse-étoupe inox. **Piquet de jardin inclus.**

36° 50 000 h

| P (w) | Lumens | Teinte | Code | € HT  |
|-------|--------|--------|------|-------|
| 3,6   | 240    | 3500 K | 5058 | 83,60 |

**SUB 50 - Immergeable**

**Intensif**



Profondeur maxi d'immersion 1 m. Corps nylon thermo-résistant. Fixation murale et piquet de jardin inclus. Précâblage longueur 2,7 m. HO5RN8F 2x1 mm<sup>2</sup> (immergeable). N'utiliser que des lampes à réflecteur aluminium.

| P (W) | Douille | Couleur | Code avec lampe | € HT         |
|-------|---------|---------|-----------------|--------------|
| 50    | GU5,3   | blanc   | <b>0801</b>     | <b>71,20</b> |
| 50    | GU5,3   | noir    | <b>0802</b>     | <b>71,20</b> |

Lampe de rechange, code **2777**.  
Verre de rechange, code **2106**.

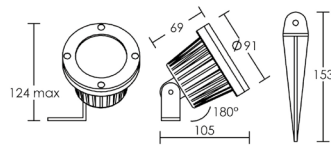

| SUB 50 | 2950 K                | 50 W  | 36° |
|--------|-----------------------|-------|-----|
| h (m)  | E <sub>max</sub> (lx) | d (m) |     |
| 1      | <b>1800</b>           | 0,65  |     |
| 2      | <b>450</b>            | 1,3   |     |
| 3      | <b>200</b>            | 1,9   |     |

**ACCESSOIRE**



**TRANSFORMATEUR**

Transfo. 50W IP66 + Fiche IP44 2P 16A - Câble 2,70 m H05RN-F 2x1 mm<sup>2</sup> (non immergeable)

| Désignation       | Code        | € HT         |
|-------------------|-------------|--------------|
| Transfo. 50W IP66 | <b>0888</b> | <b>64,90</b> |

**Ne pas enterrer ou immerger.**

**KIT SUB 50 - Immergeable**

**Intensif**

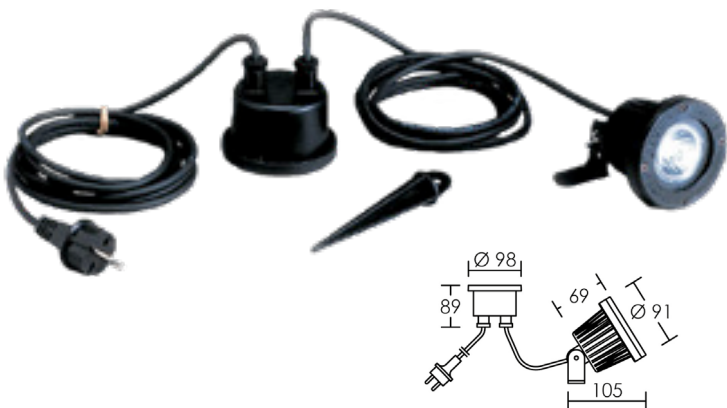

Kit prêt-à-installer : projecteur SUB 50 IP68 - 1 m, transformateur IP66 et piquet de jardin.  
Précâblage longueur 2,7 m chaque :  
1/ Primaire 230V - H05RN-F 2x 1 mm<sup>2</sup> (non immergeable) + fiche IP44 2P 16A  
2/ Secondaire 12V - HO5RN8F 2x 1 mm<sup>2</sup> (immergeable).

| P (W) | Douille | Couleur | Code avec lampe | € HT          |
|-------|---------|---------|-----------------|---------------|
| 50    | GU5,3   | noir    | <b>4685</b>     | <b>163,30</b> |

**Ne pas enterrer ou immerger le transformateur.**

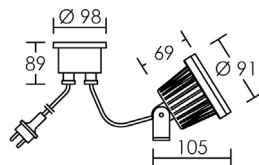

| SUB 50 | 2950 K                | 50 W  | 36° |
|--------|-----------------------|-------|-----|
| h (m)  | E <sub>max</sub> (lx) | d (m) |     |
| 1      | <b>1800</b>           | 0,65  |     |
| 2      | <b>450</b>            | 1,3   |     |
| 3      | <b>200</b>            | 1,9   |     |

# SOMMAIRE | EXTÉRIEUR : HUBLOT APPLIQUÉ

## HUBLOT FONCTIONNEL

ADELA .....p. 328



GAIA .....p. 329



RHEA CCT .....p. 331



GEA .....p. 332



ORIA .....p. 333



POLAR 312 .....p. 334



ARMILLA .....p. 335



HUB 270 T .....p. 336



ECOLED .....p. 337



ORIO .....p. 337



OVO 270 T / OVO 338



OVO 270 TP .....p. 339



HUB 270 TP .....p. 339



ECO .....p. 340



OVALE .....p. 340



OVALED .....p. 341



# SOMMAIRE | EXTÉRIEUR : HUBLOT APPLIQUE

## APPLIQUE DÉCORATIVE

CANTOR...p. 342



LUXMUR...p. 343



KEELER 9...p. 344



ARGES...p. 344



TOPAZE...p. 345



AXO GUIO...p. 346



AXO LED...p. 347



TONIN...p. 348



UGOLIN...p. 349



CAMILLE...p. 350



POLO...p. 351



CALEO...p. 352



SIRIO...p. 352



LUNA...p. 353



LENA...p. 353



TERMO...p. 353



LIZIO...p. 354



MURA...p. 355



CORSO...p. 355



MONACO...p. 356



TOSCANE...p. 357



LAMPARO...p. 357



NIZA L...p. 357



LAMPE

DOWNLIGHT  
ENCASTRE

RAIL  
PROJECTEUR  
SPOTERIE

RÉGLIETTE

RUBAN  
PROFILÉ

APPLIQUE  
PLAFONNIER  
SUSPENSION

EXTÉRIEUR :  
PROJECTEUR

EXTÉRIEUR :  
HUBLOT  
APPLIQUE



1000 lm

Corps thermoplastique blanc/Diffuseur polycarbonate blanc.



Version SENSOR



Détecteur de passage intégré. Mode crépusculaire.

| ◁ 110° |        | 25 000 h |              |              |
|--------|--------|----------|--------------|--------------|
| P (w)  | Lumens | Teinte   | Code         | € HT         |
| 14     | 1000   | ○ 4000 K | <b>50732</b> | <b>50,00</b> |

| 50732 | 4000K                 | 13 W  | 110° |
|-------|-----------------------|-------|------|
| h (m) | E <sub>max</sub> (lx) | d (m) |      |
| 1     | 331                   | 2,86  |      |
| 2     | 83                    | 5,7   |      |
| 3     | 37                    | 8,6   |      |

Version standard

| ◁ 110° |        | 25 000 h |              |              |
|--------|--------|----------|--------------|--------------|
| P (w)  | Lumens | Teinte   | Code         | € HT         |
| 13     | 1000   | ○ 4000 K | <b>50731</b> | <b>28,60</b> |

| 50731 | 4000K                 | 13 W  | 110° |
|-------|-----------------------|-------|------|
| h (m) | E <sub>max</sub> (lx) | d (m) |      |
| 1     | 331                   | 2,86  |      |
| 2     | 83                    | 5,7   |      |
| 3     | 37                    | 8,6   |      |

PRINCIPE DE FONCTIONNEMENT SENSOR

- ✓ Possibilité de régler la sensibilité de la détection, de 10 à 100%
- ✓ Possibilité de régler la durée d'éclairage, de 5 s à 15 min
- ✓ Possibilité de régler la détection crépusculaire sur 3 niveaux : 300 lux - 75 lux - 20 lux.

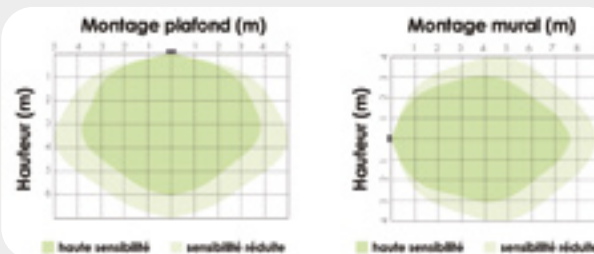



GAIA



1500 lm

Corps thermoplastique blanc/Diffuseur polycarbonate blanc.

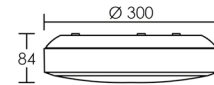

Version SENSOR

Détecteur de passage intégré.



| ◁ 110° |        |          |              |              | 30 000 h |
|--------|--------|----------|--------------|--------------|----------|
| P (w)  | Lumens | Teinte   | Code         | € HT         |          |
| 15,5   | 1500   | ○ 4000 K | <b>50730</b> | <b>70,40</b> |          |

| 50730 | 4000K                 | 15,5W | 110° |
|-------|-----------------------|-------|------|
| h (m) | E <sub>max</sub> (lx) | d (m) |      |
| 1     | <b>545</b>            | 2,86  |      |
| 2     | <b>136</b>            | 5,7   |      |
| 3     | <b>61</b>             | 8,6   |      |

Version standard

| ◁ 110° |        |          |              |              | 30 000 h |
|--------|--------|----------|--------------|--------------|----------|
| P (w)  | Lumens | Teinte   | Code         | € HT         |          |
| 14,5   | 1500   | ○ 4000 K | <b>50729</b> | <b>54,10</b> |          |

| 50729 | 4000K                 | 14,5W | 110° |
|-------|-----------------------|-------|------|
| h (m) | E <sub>max</sub> (lx) | d (m) |      |
| 1     | <b>545</b>            | 2,86  |      |
| 2     | <b>136</b>            | 5,7   |      |
| 3     | <b>61</b>             | 8,6   |      |

PRINCIPE DE FONCTIONNEMENT SENSOR

- ✓ Possibilité de régler la sensibilité de la détection, de 10 à 100%
- ✓ Possibilité de régler la durée d'éclairage, de 5 s à 15 min

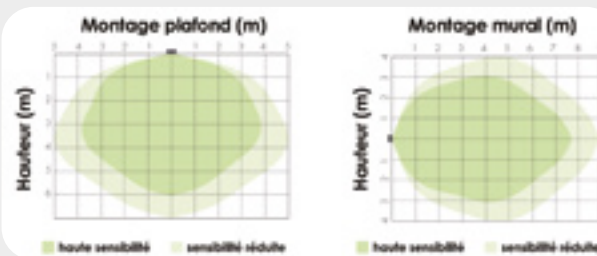

LAMPE

DOWNLIGHT ENCASTRE

RAIL PROJECTEUR SPOTIERIE

RÉGLIETTE

RUBAN PROFILÉ

APPLIQUE PLAFONNIER SUSPENSION

EXTÉRIEUR : PROJECTEUR

EXTÉRIEUR : HUBLLOT



RHEA CCT



2300 lm

Corps et diffuseur polycarbonate blanc/Diffuseur opale.

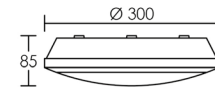

Version SENSOR



Détecteur de passage intégré. Mode crépusculaire.

3000 K / 4000 K 35 000 h

| P (w) | Lumens | Couleur | Code  | € HT  |
|-------|--------|---------|-------|-------|
| 21    | 2300   | blanc   | 50909 | 78,00 |

Données de la LED en 4000 K.

| h (m) | E <sub>max</sub> (lx) | d (m) |
|-------|-----------------------|-------|
| 1     | 717                   | 2,86  |
| 2     | 179                   | 5,7   |
| 3     | 80                    | 8,6   |

Version standard

3000 K / 4000 K 35 000 h

| P (w) | Lumens | Couleur | Code  | € HT  |
|-------|--------|---------|-------|-------|
| 10    | 1150   | blanc   | 50907 | 54,00 |
| 21    | 2200   | blanc   | 50908 | 58,00 |

Données de la LED en 4000 K.

| h (m) | E <sub>max</sub> (lx) | d (m) |
|-------|-----------------------|-------|
| 1     | 380                   | 2,86  |
| 2     | 95                    | 5,7   |
| 3     | 42                    | 8,6   |

| h (m) | E <sub>max</sub> (lx) | d (m) |
|-------|-----------------------|-------|
| 1     | 725                   | 2,86  |
| 2     | 181                   | 5,7   |
| 3     | 81                    | 8,6   |

ACCESSOIRES



Collerettes 1/4 de tour.

| Désignation       | Code  | € HT |
|-------------------|-------|------|
| Demi-lune blanche | 50910 | 6,80 |
| Demi-lune noire   | 50911 | 6,80 |
| Collerette noire  | 50912 | 3,50 |

LAMPE

DOWNLIGHT ENCASTRE

RAIL PROJECTEUR SPOTIERIE

RÉGLIETTE

RUBAN PROFILÉ

APPLIQUE PLAFONNIER SUSPENSION

EXTÉRIEUR : PROJECTEUR

EXTÉRIEUR : HUBLLOT



1800 lm

Corps et diffuseur polycarbonate blanc/Diffuseur opale.

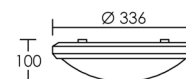

Version LED DIMMABLE



|       |        |                       |       |
|-------|--------|-----------------------|-------|
| 50309 | 4000 K | 20 W                  | 120°  |
|       | h (m)  | E <sub>max</sub> (lx) | d (m) |
|       | 1      | 525                   | 3,46  |
|       | 2      | 131                   | 6,9   |
|       | 3      | 58                    | 10,4  |

|       |        |          |       | 50 000 h |
|-------|--------|----------|-------|----------|
| P (w) | Lumens | Teinte   | Code  | € HT     |
| 20    | 1800   | ○ 4000 K | 50309 | 130,60   |

Dimmable par coupure de phase.

Version sans lampe

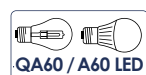

| P (w) | Douille | Couleur | Code sans lampe | € HT  |
|-------|---------|---------|-----------------|-------|
| 60    | E27     | blanc   | 3647            | 37,10 |



LED p. 20

ORIA



950 lm

Corps et diffuseur polycarbonate blanc/Diffuseur cristal transparent.

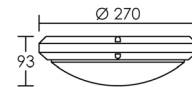

Version LED DIMMABLE



|       |                       |       |      |
|-------|-----------------------|-------|------|
| 50319 | 4000 K                | 10 W  | 125° |
| h (m) | E <sub>max</sub> (lx) | d (m) |      |
| 1     | 262                   | 3,84  |      |
| 1,5   | 116                   | 5,8   |      |
| 2     | 66                    | 7,7   |      |

|          |        |          |       |       |
|----------|--------|----------|-------|-------|
| 35 000 h |        |          |       |       |
| P (w)    | Lumens | Teinte   | Code  | € HT  |
| 10       | 950    | ○ 4000 K | 50319 | 84,70 |

Dimmable par coupure de phase.

Version LED NON DIMMABLE



|       |                       |       |      |
|-------|-----------------------|-------|------|
| 50321 | 4000 K                | 10 W  | 120° |
| h (m) | E <sub>max</sub> (lx) | d (m) |      |
| 1     | 176                   | 3,46  |      |
| 2     | 44                    | 6,9   |      |
| 2,5   | 28                    | 8,7   |      |

|          |        |          |       |       |
|----------|--------|----------|-------|-------|
| 35 000 h |        |          |       |       |
| P (w)    | Lumens | Teinte   | Code  | € HT  |
| 10       | 650    | ○ 4000 K | 50321 | 47,90 |

Version sans lampe



|       |         |         |                 |       |
|-------|---------|---------|-----------------|-------|
| P (w) | Douille | Couleur | Code sans lampe | € HT  |
| 60    | E27     | blanc   | 3649            | 25,50 |



LAMPE

DOWNLIGHT ENCASTRE

RAIL PROJECTEUR SPOTIERIE

RÉGLIETTE

RUBAN PROFILÉ

APPLIQUE PLAFONNIER SUSPENSION

EXTÉRIEUR : PROJECTEUR

EXTÉRIEUR : HUBLLOT

## POLAR 312

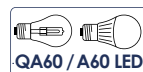

Corps thermoplastique blanc/Diffuseur polycarbonate.

| P (w) | Douille | Couleur    | Code sans lampe | € HT         |
|-------|---------|------------|-----------------|--------------|
| 75    | E27     | blanc      | <b>1898</b>     | <b>39,80</b> |
| 75    | E27     | gris métal | <b>1899</b>     | <b>64,80</b> |



LED p. 20

ARMILLA

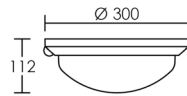
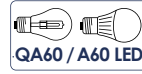

Support et diffuseur polycarbonate blanc. **Détecteur de mouvement infrarouge.**

| P (w) | Douille | Couleur | Code sans lampe | € HT  |
|-------|---------|---------|-----------------|-------|
| 60    | E27     | blanc   | 4004            | 96,50 |

Détail de la détection p. 422.

DÉTECTION ARMILLA

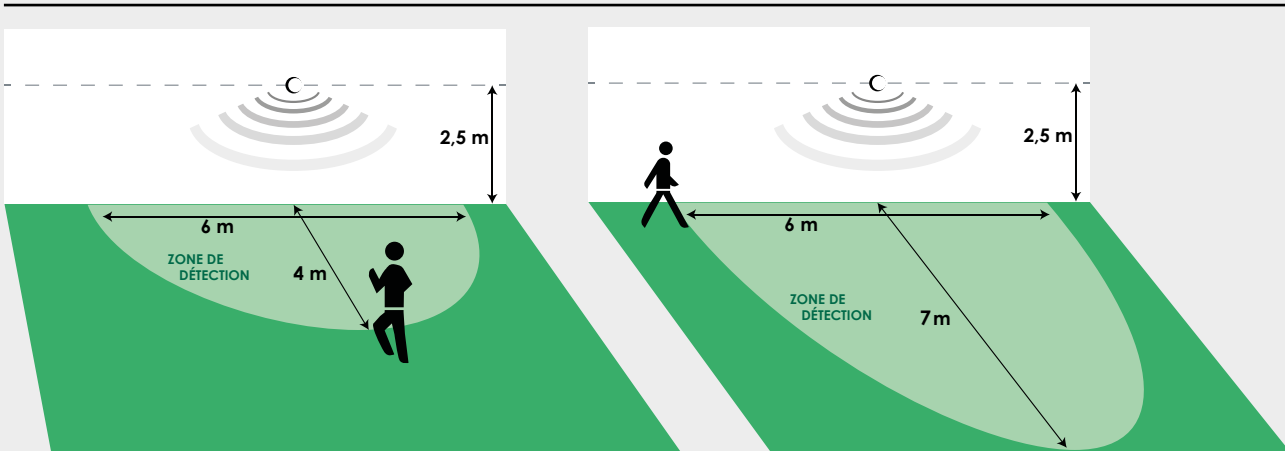

LAMPE

DOWNLIGHT ENCASTRE

RAIL PROJECTEUR SPOTIERIE

RÉGLIETTE

RUBAN PROFILÉ

APPLIQUE PLAFONNIER SUSPENSION

EXTÉRIEUR : PROJECTEUR

EXTÉRIEUR : HUBLLOT

HUB 270 T

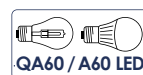

Corps thermoplastique/Diffuseur polycarbonate opale blanc. Visserie inox.



Version 650°



| P (w) | Douille | Couleur | Code sans lampe | € HT  |
|-------|---------|---------|-----------------|-------|
| 75    | E27     | noir    | 1745            | 38,20 |
| 75    | E27     | blanc   | 1746            | 36,70 |

Version 850°



| P (w) | Douille | Couleur | Code sans lampe | € HT  |
|-------|---------|---------|-----------------|-------|
| 75    | E27     | blanc   | 1753            | 42,10 |



ECOLED



500 lm

Corps thermoplastique/Diffuseur polycarbonate opale blanc. Visserie inox.

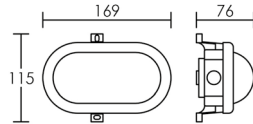

25 000 h

| P (w) | Lumens | Teinte   | Code         | € HT         |
|-------|--------|----------|--------------|--------------|
| 5,5   | 500    | ○ 4000 K | <b>50416</b> | <b>15,30</b> |

| 50416 | 4000 K                | 5,5 W | 125° |
|-------|-----------------------|-------|------|
| h (m) | E <sub>max</sub> (lx) | d (m) |      |
| 1     | 137                   | 3,84  |      |
| 2     | 34                    | 7,7   |      |
| 2,5   | 22                    | 9,6   |      |

ORIO



Corps et diffuseur polycarbonate blanc/Diffuseur opale.

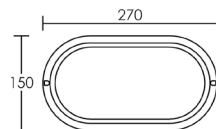

| P (w) | Douille | Couleur | Code sans lampe | € HT         |
|-------|---------|---------|-----------------|--------------|
| 60    | E27     | blanc   | <b>3650</b>     | <b>22,30</b> |



LED p. 20

LAMPE

DOWNLIGHT ENCASTRE

RAIL PROJECTEUR SPOTIERIE

RÉGLLETTE

RUBAN PROFILÉ

APPLIQUE PLAFONNIER SUSPENSION

EXTÉRIEUR : PROJECTEUR

EXTÉRIEUR : HUBLLOT

OVO 270 T



Corps thermoplastique/Diffuseur polycarbonate opale blanc. Visserie inox.

| P (w) | Douille | Couleur | Code sans lampe | € HT  |
|-------|---------|---------|-----------------|-------|
| 60    | E27     | noir    | 1725            | 31,40 |
| 60    | E27     | blanc   | 1726            | 31,40 |

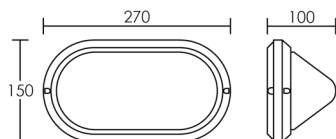

OVO 330



Corps thermoplastique/Diffuseur polycarbonate opale blanc. Visserie inox.

| P (w) | Douille | Couleur | Code sans lampe | € HT  |
|-------|---------|---------|-----------------|-------|
| 75    | E27     | blanc   | 1736            | 38,20 |

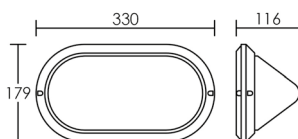

## OVO 270 TP



Corps thermoplastique/Diffuseur polycarbonate opale blanc. Visserie inox.

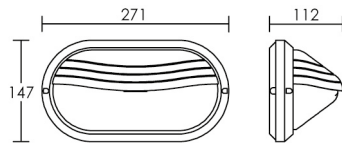

| P (w) | Douille | Couleur | Code sans lampe | € HT         |
|-------|---------|---------|-----------------|--------------|
| 40    | E27     | noir    | <b>2201</b>     | <b>34,10</b> |
| 40    | E27     | blanc   | <b>2202</b>     | <b>34,10</b> |



## HUB 270 TP



Corps thermoplastique/Diffuseur polycarbonate opale blanc. Visserie inox.



| P (w) | Douille | Couleur | Code sans lampe | € HT         |
|-------|---------|---------|-----------------|--------------|
| 40    | E27     | noir    | <b>2205</b>     | <b>40,70</b> |
| 40    | E27     | blanc   | <b>2206</b>     | <b>40,70</b> |



LAMPE

DOWNLIGHT ENCASTRE

RAIL PROJECTEUR SPOTERIE

RÉGLIETTE

RUBAN PROFILÉ

APPLIQUE PLAFONNIER SUSPENSION

EXTÉRIEUR : PROJECTEUR

EXTÉRIEUR : HUBLLOT

ECO ROND



Corps et grille thermoplastique/Verre strié.

| P (w) | Douille | Couleur | Code sans lampe | € HT  |
|-------|---------|---------|-----------------|-------|
| 100   | E27     | blanc   | 3637            | 11,70 |

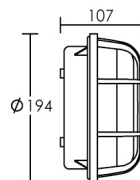

ECO OVALE



Corps et grille thermoplastique/Verre strié.

| P (w) | Douille | Couleur | Code sans lampe | € HT |
|-------|---------|---------|-----------------|------|
| 60    | E27     | blanc   | 3632            | 5,30 |

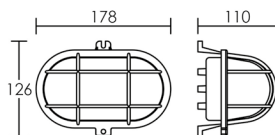

OVALE BLANC



Corps thermoplastique/Grille métal/Verre strié.

| P (w) | Douille | Couleur | Code sans lampe | € HT |
|-------|---------|---------|-----------------|------|
| 60    | E27     | blanc   | 3630            | 4,70 |

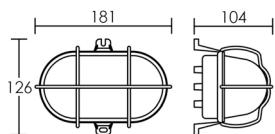

OVALED



750 lm

Corps thermoplastique/Grille métal/Verre strié opale.

◁ 150°

35 000 h

| P (W)      | Lumens | Teinte   | Code         | € HT         |
|------------|--------|----------|--------------|--------------|
| <b>N</b> 8 | 750    | ○ 4000 K | <b>50866</b> | <b>25,20</b> |

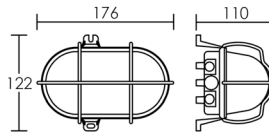

| 50866 | 4000K                 | 8W    | 150° |
|-------|-----------------------|-------|------|
| h (m) | E <sub>max</sub> (lx) | d (m) |      |
| 1     | 159                   | 7,46  |      |
| 2     | 40                    | 14,9  |      |
| 3     | 18                    | 22,4  |      |



LAMPE

DOWNLIGHT  
ENCASTRE

RAIL  
PROJECTEUR  
SPOTERIE

RÉGLIETTE

RUBAN  
PROFILÉ

APPLIQUE  
PLAFONNIER  
SUSPENSION

EXTÉRIEUR :  
PROJECTEUR

EXTÉRIEUR :  
HUBLLOT

CANTOR



340 lm

Corps aluminium noir/Diffuseur polycarbonate transparent. Eclairage dirigé vers le sol. Faisceau 50° asymétrique à 25°. **Alimentation intégrée.**

Version R (ronde)



Version C (carrée)



25 000 h

| P (w) | Lumens | Teinte   | Code         | € HT          |
|-------|--------|----------|--------------|---------------|
| 9,5   | 340    | ○ 4000 K | <b>50217</b> | <b>185,60</b> |

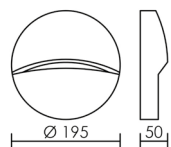

| 50217 | 4000 K                | 9,5 W | 50° asy. 25° |
|-------|-----------------------|-------|--------------|
| h (m) | E <sub>max</sub> (lx) | d (m) |              |
| 1     | <b>234</b>            | 0,93  |              |
| 2     | <b>58</b>             | 1,9   |              |
| 3     | <b>26</b>             | 2,8   |              |

25 000 h

| P (w) | Lumens | Teinte   | Code         | € HT          |
|-------|--------|----------|--------------|---------------|
| 9,5   | 310    | ○ 4000 K | <b>50218</b> | <b>185,60</b> |

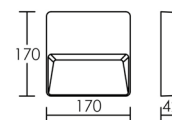

| 50218 | 4000 K                | 9,5 W | 50° asy. 25° |
|-------|-----------------------|-------|--------------|
| h (m) | E <sub>max</sub> (lx) | d (m) |              |
| 1     | <b>225</b>            | 0,93  |              |
| 2     | <b>56</b>             | 1,9   |              |
| 3     | <b>25</b>             | 2,8   |              |

LUXMUR 3



Corps polycarbonate/Nylon. Verre de protection. Passe-fil.

Version R (ronde)



Version C (carrée)



| P (w) | Douille | Couleur  | Code sans lampe | € HT  |
|-------|---------|----------|-----------------|-------|
| 9     | GX53    | graphite | 1739            | 75,60 |

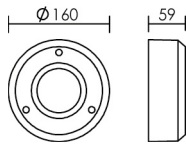

| P (w) | Douille | Couleur  | Code sans lampe | € HT  |
|-------|---------|----------|-----------------|-------|
| 9     | GX53    | graphite | 1740            | 83,90 |

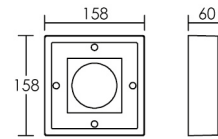

Lampes adaptées à ces appareils (p. 27) :

GX53 - LED 7W



700 lm

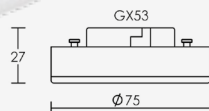

Lampe plate MULTILED. Culot GX53.

| P (w) | Faisceau | Lumens | Teinte   | Code | € HT  |
|-------|----------|--------|----------|------|-------|
| 7     | 110°     | 550    | ● 2700 K | 2942 | 27,20 |
| 7     | 110°     | 700    | ○ 4000 K | 2992 | 27,20 |

| GX53  | 2700K                 | 7W    | 110° |
|-------|-----------------------|-------|------|
| h (m) | E <sub>max</sub> (lx) | d (m) |      |
| 1     | 203                   | 2,86  |      |
| 2     | 51                    | 5,7   |      |
| 2,5   | 33                    | 7,1   |      |

| GX53  | 4000K                 | 7W    | 110° |
|-------|-----------------------|-------|------|
| h (m) | E <sub>max</sub> (lx) | d (m) |      |
| 1     | 259                   | 2,86  |      |
| 2     | 65                    | 5,7   |      |
| 2,5   | 41                    | 7,1   |      |

## KEELER 9



295 lm

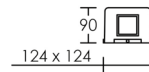

Corps en aluminium extrudé graphite/Diffuseur polycarbonate transparent. Montage en applique ou au sol. **Alimentation intégrée.**

◁ 50° 25 000 h

| P (w) | Lumens | Teinte   | Code         | € HT          |
|-------|--------|----------|--------------|---------------|
| 8     | 295    | ● 3000 K | <b>50278</b> | <b>262,10</b> |

## ARGES



900 lm

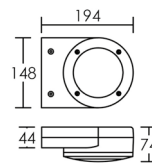

Corps aluminium/Diffuseur polycarbonate transparent  
Peut être installé dans toutes les positions.

◁ 60° 50 000 h

| P (w) | Lumens | Teinte   | Code         | € HT          |
|-------|--------|----------|--------------|---------------|
| 10    | 900    | ● 3000 K | <b>50618</b> | <b>218,30</b> |

Dimmable par coupure de phase.

| 50618   | 3000K                 | 10 W  | 60° |       |                       |       |   |            |      |   |            |     |   |           |     |
|---|-----------------------|-------|-----|-------|-----------------------|-------|---|------------|------|---|------------|-----|---|-----------|-----|
| <table border="1"> <thead> <tr> <th>h (m)</th> <th>E<sub>max</sub> (lx)</th> <th>d (m)</th> </tr> </thead> <tbody> <tr> <td>1</td> <td><b>874</b></td> <td>1,15</td> </tr> <tr> <td>2</td> <td><b>219</b></td> <td>2,3</td> </tr> <tr> <td>3</td> <td><b>97</b></td> <td>3,5</td> </tr> </tbody> </table> |                       |       |     | h (m) | E <sub>max</sub> (lx) | d (m) | 1 | <b>874</b> | 1,15 | 2 | <b>219</b> | 2,3 | 3 | <b>97</b> | 3,5 |
| h (m)   | E <sub>max</sub> (lx) | d (m) |     |       |                       |       |   |            |      |   |            |     |   |           |     |
| 1   | <b>874</b>            | 1,15  |     |       |                       |       |   |            |      |   |            |     |   |           |     |
| 2   | <b>219</b>            | 2,3   |     |       |                       |       |   |            |      |   |            |     |   |           |     |
| 3   | <b>97</b>             | 3,5   |     |       |                       |       |   |            |      |   |            |     |   |           |     |



TOPAZE



1000 lm

Corps en aluminium graphite/Verre de protection transparent. Boîte de connexion.



Version 1 tête - Lampe 3000 K

|       |        |          |       |       |
|-------|--------|----------|-------|-------|
| 36°   | GU10   | 15 000 h |       |       |
| P (w) | Lumens | Teinte   | Code  | € HT  |
| 6     | 500    | 3000 K   | 50916 | 45,00 |



Version 2 têtes - Lampe 3000 K

|       |        |          |       |       |
|-------|--------|----------|-------|-------|
| 36°   | GU10   | 15 000 h |       |       |
| P (w) | Lumens | Teinte   | Code  | € HT  |
| 2x 6  | 2x 500 | 3000 K   | 50917 | 58,00 |

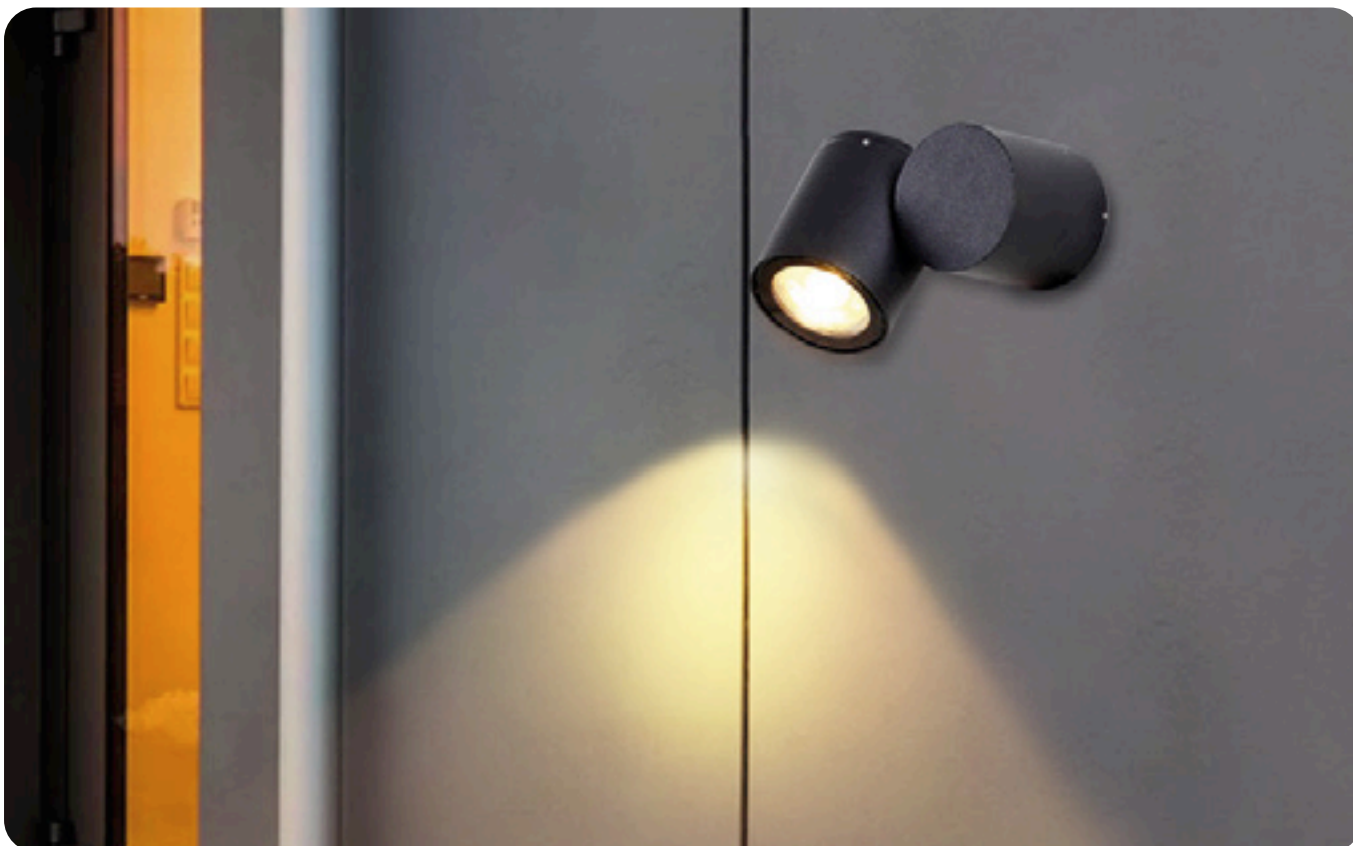

LAMPE

DOWNLIGHT  
ENCASTRE

RAIL  
PROJECTEUR  
SPOTERIE

RÉGLLETTE

RUBAN  
PROFILÉ

APPLIQUE  
PLAFONNIER  
SUSPENSION

EXTÉRIEUR :  
PROJECTEUR

EXTÉRIEUR :  
APPLIQUE

AXO GU10



Corps aluminium graphite extrudé anthracite. Verre de protection. Eclairage direct/indirect.

Version Haut/Bas - Lampe 3000 K



Version Bas - Lampe 3000 K



|               | 36° | GU10   |        | 15 000 h     |
|---------------|-----|--------|--------|--------------|
| P (w)         |     | Lumens | Teinte | Code         |
| <b>N</b> 2x 6 |     | 2x 470 | 3000 K | <b>3136</b>  |
|               |     |        |        | € HT         |
|               |     |        |        | <b>46,00</b> |

|            | 36° | GU10   |        | 15 000 h     |
|------------|-----|--------|--------|--------------|
| P (w)      |     | Lumens | Teinte | Code         |
| <b>N</b> 6 |     | 470    | 3000 K | <b>3137</b>  |
|            |     |        |        | € HT         |
|            |     |        |        | <b>36,00</b> |

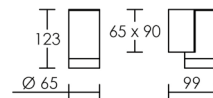
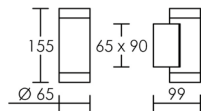

AXO LED



1500 lm

Corps en aluminium/Diffuseur polycarbonate transparent. **Alimentation intégrée.**  
Eclairage direct/indirect.



◁ 50° 30 000 h

| P (w) | Lumens | Teinte   | Code         | € HT          |
|-------|--------|----------|--------------|---------------|
| 2x 10 | 2x 750 | ☉ 3000 K | <b>50527</b> | <b>175,40</b> |

Dimmable par coupure de phase.

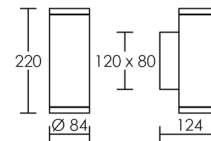

| AXO LED | 3000K | 2x10W                 | 50°   |
|---------|-------|-----------------------|-------|
|         | h (m) | E <sub>max</sub> (lx) | d (m) |
|         | 1     | 1010                  | 0,93  |
|         | 2     | 253                   | 1,9   |
|         | 3     | 112                   | 2,8   |
|         | 4     | 63                    | 3,7   |
|         | 5     | 40                    | 4,7   |

ACCESSOIRES AXO LED



| Désignation         | Code        | € HT        |
|---------------------|-------------|-------------|
| Réflecteur alu. 20° | <b>0134</b> | <b>8,20</b> |
| Réflecteur alu. 35° | <b>0135</b> | <b>8,20</b> |

LAMPE

DOWNLIGHT ENCASTRE

RAIL PROJECTEUR SPOTIERIE

RÉGLIETTE

RUBAN PROFILÉ

APPLIQUE PLAFONNIER SUSPENSION

EXTÉRIEUR : PROJECTEUR

EXTÉRIEUR : APPLIQUE

TONIN

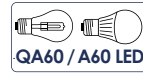

Corps aluminium extrudé/Diffuseur verre transparent/  
Paralume inox.



|          | P (w) | Douille | Couleur | Code sans lampe | € HT         |
|----------|-------|---------|---------|-----------------|--------------|
| <b>N</b> | 100   | E27     | noir    | <b>3138</b>     | <b>82,00</b> |

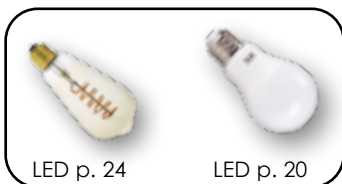
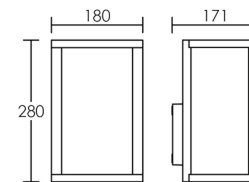

LED p. 24

LED p. 20

UGOLIN

IRC  
>85



230V

IP  
54



650°C

580 lm

Corps en aluminium extrudé graphite/Diffuseur polycarbonate transparent. **Alimentation intégrée.**

◁ 180°

40 000 h

| P (w) | Lumens | Teinte   | Code  | € HT  |
|-------|--------|----------|-------|-------|
| N 10  | 580    | ● 3000 K | 50913 | 71,00 |

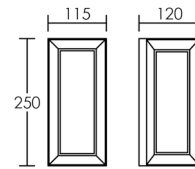

LAMPE

DOWNLIGHT  
ENCASTRE

RAIL  
PROJECTEUR  
SPOTERIE

RÉGLIETTE

RUBAN  
PROFILÉ

APPLIQUE  
PLAFONNIER  
SUSPENSION

EXTÉRIEUR :  
PROJECTEUR

EXTÉRIEUR :  
APPLIQUE

CAMILLE



375 lm

Corps aluminium graphite/Diffuseur polycarbonate opale.

Version 1

Version 2



|        |        |          |       |        |
|--------|--------|----------|-------|--------|
| ◁ 130° |        | 50 000 h |       |        |
| P (w)  | Lumens | Teinte   | Code  | € HT   |
| 10     | 375    | 3000 K   | 50542 | 221,30 |

|        |        |          |       |        |
|--------|--------|----------|-------|--------|
| ◁ 130° |        | 50 000 h |       |        |
| P (w)  | Lumens | Teinte   | Code  | € HT   |
| 10     | 375    | 3000 K   | 50543 | 221,30 |

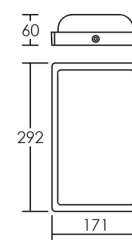
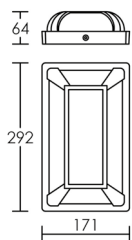

POLO LED



790 lm

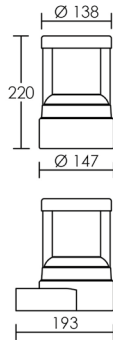

Corps aluminium graphite/Diffuseur polycarbonate anti-UV. LED Citizen (IRC >80). **Alimentation intégrée IP67.**

◀ 150° 50 000 h

| P (w) | Lumens | Teinte   | Code         | € HT          |
|-------|--------|----------|--------------|---------------|
| 10    | 790    | ○ 4000 K | <b>50614</b> | <b>328,40</b> |

POLO



Corps aluminium extrudé/Diffuseur polycarbonate transparent/Paralume inox.

| P (w) | Douille | Couleur   | Code sans lampe | € HT          |
|-------|---------|-----------|-----------------|---------------|
| 70    | E27     | graphite  | <b>3120</b>     | <b>219,80</b> |
| 70    | E27     | gris alu. | <b>3122</b>     | <b>219,80</b> |



LAMPE

DOWNLIGHT ENCASTRE

RAIL PROJECTEUR SPOTERIE

RÉGLIETTE

RUBAN PROFILÉ

APPLIQUE PLAFONNIER SUSPENSION

EXTÉRIEUR : PROJECTEUR

EXTÉRIEUR : APPLIQUE

CALEO 1

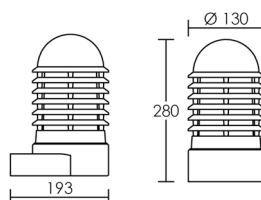
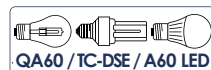

Corps aluminium/Diffuseur polycarbonate opale/  
Vis inox.

| P (w) | Douille | Couleur  | Code sans lampe | € HT   |
|-------|---------|----------|-----------------|--------|
| 75    | E27     | noir     | 1794            | 202,70 |
| 75    | E27     | blanc    | 1777            | 202,70 |
| 75    | E27     | gris     | 1692            | 200,90 |
| 75    | E27     | graphite | 3133            | 200,90 |



SIRIO

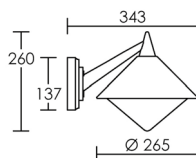
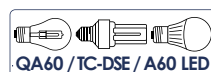

Corps aluminium/Diffuseur polycarbonate opale.

| P (w) | Douille | Couleur | Code sans lampe | € HT  |
|-------|---------|---------|-----------------|-------|
| 75    | E27     | blanc   | 1889            | 92,70 |
| 75    | E27     | noir    | 1862            | 92,70 |





LUNA

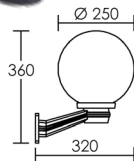

base 100 x 100  
entraxe 83 mm

Applique Ø250 mm. Support thermoplastique/  
Globe PMMA.

| P (w) | Douille | Couleur     | Code sans lampe | € HT  |
|-------|---------|-------------|-----------------|-------|
| 100   | E27     | noir fumé   | 1708            | 44,40 |
| 100   | E27     | blanc opale | 1704            | 44,40 |

LENA

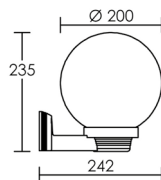

Applique Ø200 mm. Support thermoplastique/  
Globe PMMA.

| P (w) | Douille | Couleur     | Code sans lampe | € HT  |
|-------|---------|-------------|-----------------|-------|
| 60    | E27     | noir fumé   | 1707            | 31,10 |
| 60    | E27     | blanc opale | 1719            | 31,10 |

TERMO

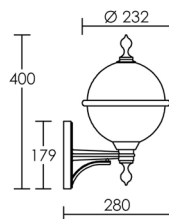

Support thermoplastique/Globe opale.

| P (w) | Douille | Couleur | Code sans lampe | € HT  |
|-------|---------|---------|-----------------|-------|
| 60    | E27     | noir    | 1945            | 66,20 |

LAMPE

DOWNLIGHT  
ENCASTRE

RAIL  
PROJECTEUR  
SPOTERIE

RÉGLIETTE

RUBAN  
PROFILÉ

APPLIQUE  
PLAFONNIER  
SUSPENSION

EXTÉRIEUR :  
PROJECTEUR

EXTÉRIEUR :  
APPLIQUE

LIZIO



Corps aluminium/Diffuseur polycarbonate clair.

Version LED



400 lm



Corps noir/Diffuseur opale blanc. **Circuit LED VOSSLOH. Alimentation intégrée.**

30 000 h

| P (w) | Lumens | Teinte   | Code  | € HT   |
|-------|--------|----------|-------|--------|
| 13    | 400    | ● 2700 K | 50292 | 206,00 |

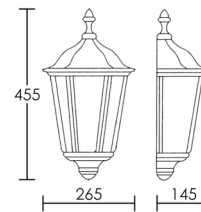

Version SENSOR



Diffuseur opale blanc. **Détecteur de présence HF.**

| P (w) | Douille | Couleur | Code sans lampe | € HT   |
|-------|---------|---------|-----------------|--------|
| 100   | E27     | noir    | 1949            | 146,60 |

Lampe fluorescente déconseillée.

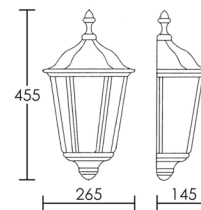

Version sans lampe



Diffuseur clair.

| P (w) | Douille | Couleur      | Code sans lampe | € HT   |
|-------|---------|--------------|-----------------|--------|
| 100   | E27     | noir         | 1930            | 107,00 |
| 100   | E27     | blanc        | 1931            | 107,00 |
| 100   | E27     | vert antique | 1932            | 107,00 |
| 100   | E27     | cuivre/noir  | 1948            | 154,70 |

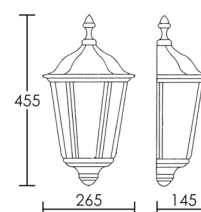

MURA



Corps aluminium/Diffuseur polycarbonate clair.

| P (w) | Douille | Couleur      | Code sans lampe | € HT   |
|-------|---------|--------------|-----------------|--------|
| 100   | E27     | blanc        | 1943            | 108,40 |
| 100   | E27     | noir         | 1942            | 108,40 |
| 100   | E27     | vert antique | 1944            | 108,40 |

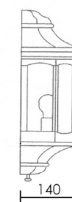
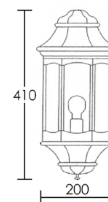

CORSO

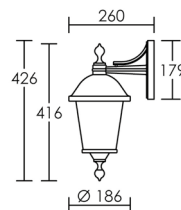
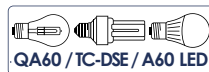

Corps thermoplastique noir/Diffuseur transparent.

| P (w) | Douille | Couleur | Code sans lampe | € HT  |
|-------|---------|---------|-----------------|-------|
| 60    | E27     | noir    | 1894            | 70,40 |

LAMPE

DOWNLIGHT ENCASTRE

RAIL PROJECTEUR SPOTIERIE

RÉGLIETTE

RUBAN PROFILÉ

APPLIQUE PLAFONNIER SUSPENSION

EXTÉRIEUR : PROJECTEUR

EXTÉRIEUR : APPLIQUE

MONACO

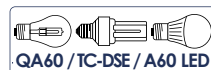

Corps aluminium/Verre clair.

Applique fixation bas



| P (w) | Douille | Couleur      | Code sans lampe | € HT   |
|-------|---------|--------------|-----------------|--------|
| 100   | E27     | blanc        | 3030            | 101,30 |
| 100   | E27     | vert antique | 3031*           | 101,30 |
| 100   | E27     | tout noir    | 3032            | 101,30 |
| 100   | E27     | cuivre/noir  | 3033            | 135,20 |

\* Sur commande délai 5 semaines.

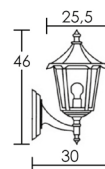

Applique fixation haut



| P (w) | Douille | Couleur      | Code sans lampe | € HT   |
|-------|---------|--------------|-----------------|--------|
| 100   | E27     | blanc        | 3034            | 101,30 |
| 100   | E27     | vert antique | 3035*           | 101,30 |
| 100   | E27     | tout noir    | 3036            | 101,30 |
| 100   | E27     | cuivre/noir  | 3037            | 135,20 |

\* Sur commande délai 5 semaines.

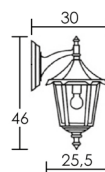

TOSCANE



Corps aluminium/Verre dépoli.

| P (w) | Douille | Couleur | Code sans lampe | € HT   |
|-------|---------|---------|-----------------|--------|
| 75    | E27     | noir    | 4070*           | 196,70 |
| 75    | E27     | cuivré  | 4080            | 196,70 |

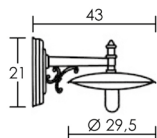

\* Sur commande délai 5 semaines.

LAMPARO



Corps aluminium/Diffuseur polycarbonate.

| P (w) | Douille | Couleur     | Code sans lampe | € HT   |
|-------|---------|-------------|-----------------|--------|
| 100   | E27     | noir        | 3081            | 127,30 |
| 100   | E27     | cuivre/noir | 3083            | 168,50 |

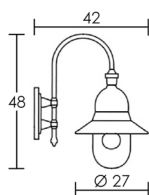

ACCESSOIRES



Fixation d'angle  
H 100 mm x L 70 mm

| Couleur | Code | € HT  |
|---------|------|-------|
| noir    | 1985 | 21,20 |
| blanc   | 1986 | 21,20 |

NIZA L

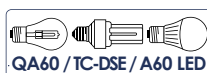

Corps aluminium/Verre clair.

| P (w) | Douille | Couleur | Code sans lampe | € HT  |
|-------|---------|---------|-----------------|-------|
| 60    | E27     | blanc   | 1934            | 81,70 |
| 60    | E27     | noir    | 1933            | 81,70 |

Jeu de verres de rechange, code 1079.

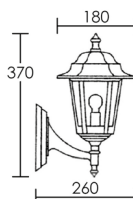

# SOMMAIRE | EXTÉRIEUR : ENCASTRÉ BORNE

## ENCASTRÉ DE MUR EXTÉRIEUR

MURENA .....p. 360



DILGA .....p. 361



BRICK LED .....p. 362



INARI .....p. 363



MODELE 300 .....p. 364



DINA .....p. 366



DINO .....p. 366



CERO .....p. 367



CARO .....p. 367



MURO .....p. 368



PIXEL .....p. 368



LUXMUR .....p. 369



LUXMUR 2 R .....p. 369



## ENCASTRÉ DE SOL EXTÉRIEUR

LUXSOL .....p. 370



LUXSOL 2 .....p. 370



TECNISOL 150 LED .....p. 371



TECNISOL 200 LED .....p. 372



TECNISOL 200 ASY .....p. 373



MIRA 65 .....p. 374



MIRA 45 .....p. 374



MIRA 65 B1/B2/B4 .....p. 375



AQUASOL MINI .....p. 376



ENZO B4 .....p. 377



EGO .....p. 378



AQUASOL MICRO .....p. 379



AQUASOL MINI .....p. 380



AQUASOL MINI  
B1/B2 .....p. 381



WALKER .....p. 382



AQUASOL MEDIUM .....p. 383



## ENCASTRÉ MINIATURE - EYELEDS

COLOREYE CS  
RGB .....p. 384



EYELEDS  
INDOOR .....p. 385



EYELEDS  
OUTDOOR .....p. 386



KIT DEAUVILLE .....p. 388



# SOMMAIRE | EXTÉRIEUR : ENCASTRÉ BORNE

## BORNE - MÂT

PIXO .....p. 389



KEELER .....p. 390



STICK .....p. 391



MORPHIS .....p. 392



SUNNY .....p. 393



NEWAY LED .....p. 394



NEWAY .....p. 395



POLO LED .....p. 396



POLO .....p. 397



TURKS .....p. 398



SAXO .....p. 399



KADO .....p. 400



CALEO 1 .....p. 402



CALEO 2 .....p. 403



DAO .....p. 404



PAO .....p. 404



NIZA B .....p. 405



GREEN .....p. 405



CORSO .....p. 406



TOSCANE .....p. 407



MONACO .....p. 408



MONACO .....p. 409



LENA .....p. 410



LUNA .....p. 411



TERMO .....p. 412



BALI .....p. 413



BRASBOUL .....p. 414



ROSA .....p. 415



MATEO .....p. 416



MORPHIS .....p. 417



MURENA



145 lm

Corps aluminium gris/Vis inox. **Alimentation intégrée.** Boîte d'encastrement fournie.

Version R (ronde)

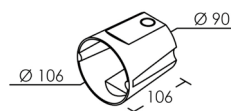
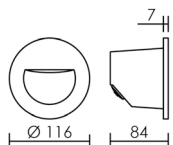

26 000 h

| P (w) | Lumens | Teinte   | Code  | € HT   |
|-------|--------|----------|-------|--------|
| 3     | 145    | ○ 4000 K | 50120 | 101,00 |

Version C (carrée)

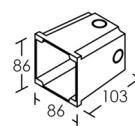
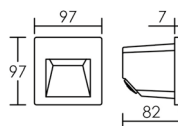

26 000 h

| P (w) | Lumens | Teinte   | Code  | € HT   |
|-------|--------|----------|-------|--------|
| 3     | 145    | ○ 4000 K | 50121 | 104,00 |

Version H (rectangulaire)

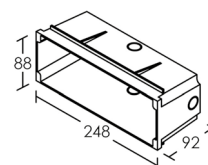
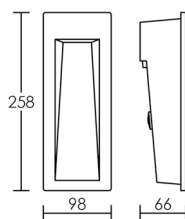

26 000 h

| P (w) | Lumens | Teinte   | Code  | € HT   |
|-------|--------|----------|-------|--------|
| 3     | 145    | ○ 4000 K | 50122 | 132,60 |



DILGA



200 lm



Corps aluminium/Façade décorative thermoplastique/  
Diffuseur polycarbonate. Faisceau asymétrique.  
Alimentation 500 mA intégrée. Précâblé avec connecteur  
IP67. Boîte d'encastrement fournie (à sceller dans la  
cloison).

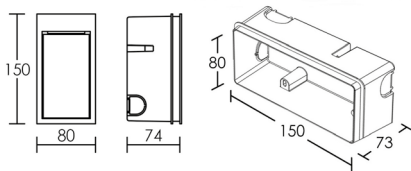

| 4,5W   |               | 3000 K            |       | 50 000 h (L80/B10) |  |
|--------|---------------|-------------------|-------|--------------------|--|
| Lumens | Couleur cadre | Couleur intérieur | Code  | € HT               |  |
| 200    | noir          | doré              | 50727 | 225,40             |  |
| 200    | gris          | gris              | 50728 | 225,40             |  |
| 200    | noir          | noir              | 50779 | 225,40             |  |
| 200    | noir          | gris              | 50780 | 225,40             |  |

LAMPE

DOWNLIGHT ENCASTRÉ

RAIL PROJECTEUR SPOTERIE

RÉGLLETTE

RUBAN PROFILÉ

APPLIQUE PLAFONNIER SUSPENSION

EXTÉRIEUR : PROJECTEUR

EXTÉRIEUR : HUBLOT APPLIQUE

EXTÉRIEUR : ENCASTRÉ

BRICK LED



115 lm

Corps aluminium anthracite/Visserie inox. **Alimentation intégrée.** Boîte d'encastrement fournie.

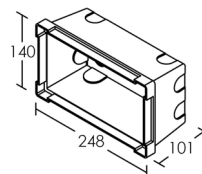
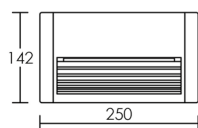

25 000 h

| P (w) | Lumens | Teinte   | Code | € HT   |
|-------|--------|----------|------|--------|
| 12    | 115    | ○ 4000 K | 5326 | 386,60 |



INARI



340 lm

Corps aluminium noir/Façade décorative en acier inoxydable. Boîte d'encastrement fournie.

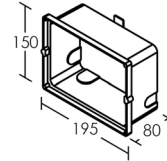
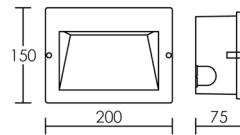

50 000 h

| P (w) | Lumens | Teinte   | Code  | € HT   |
|-------|--------|----------|-------|--------|
| 10    | 340    | ○ 4000 K | 50447 | 232,60 |

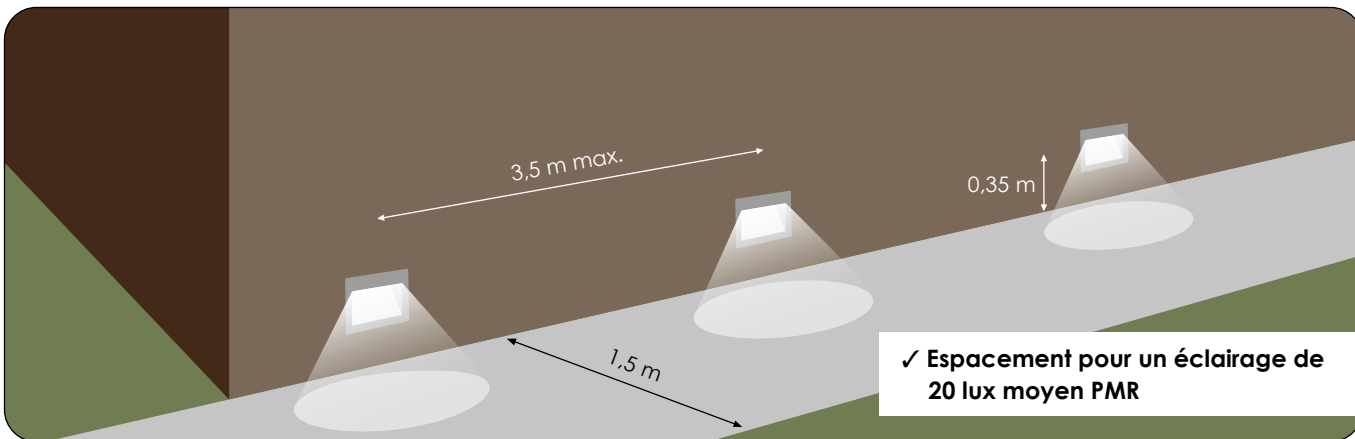

LAMPE

DOWNLIGHT ENCASTRÉ

RAIL PROJECTEUR SPOTIERIE

RÉGLIETTE

RUBAN PROFILÉ

APPLIQUE PLAFONNIER SUSPENSION

EXTÉRIEUR : PROJECTEUR

EXTÉRIEUR : HUBLOT APPLIQUE

EXTÉRIEUR : ENCASTRÉ

MODELE 300

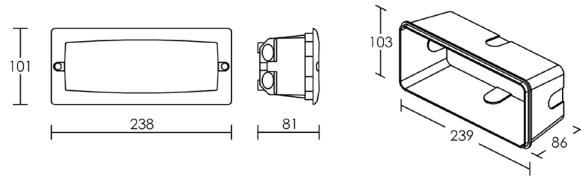

Corps aluminium/Verre opale. Boîte d'encastrement.

| P (w) | Douille | Couleur | Code sans lampe | € HT   |
|-------|---------|---------|-----------------|--------|
| 40    | E27     | blanc   | 1927            | 76,00  |
| 40    | E27     | noir    | 1928            | 76,00  |
| 40    | E27     | inox    | 5270            | 109,10 |

Verre de rechange, code 1207.

MODELE 300 G

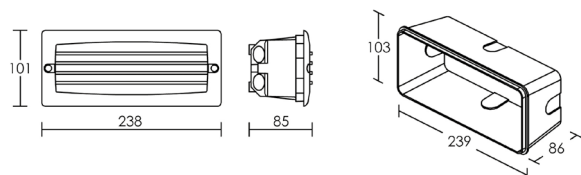

Corps aluminium/Verre opale. Boîte d'encastrement.

| P (w) | Douille | Couleur | Code sans lampe | € HT  |
|-------|---------|---------|-----------------|-------|
| 40    | E27     | blanc   | 1940            | 76,00 |
| 40    | E27     | noir    | 1941            | 81,70 |

Verre de rechange, code 1207.

MODELE 300 LED



350 lm



Corps aluminium/Colerette inox 31 6L/Verre opale.  
Boîte d'encastrement. **Alimentation intégrée.**

30 000 h

| P (w) | Lumens | Teinte   | Code        | € HT          |
|-------|--------|----------|-------------|---------------|
| 6     | 350    | ○ 4000 K | <b>5269</b> | <b>282,50</b> |

Verre de rechange, code **1207**.

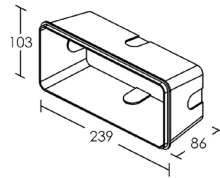
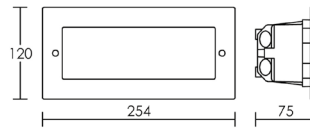
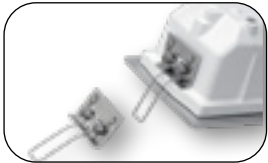

ACCESSOIRE

Ressorts de fixation pour encastrement dans les cloisons sèches.

| Référence                   | Code        | € HT         |
|-----------------------------|-------------|--------------|
| Jeu de ressorts de fixation | <b>0780</b> | <b>19,30</b> |



LAMPE

DOWNLIGHT ENCASTRÉ

RAIL PROJECTEUR SPOTIERIE

RÉGLIETTE

RUBAN PROFILÉ

APPLIQUE PLAFONNIER SUSPENSION

EXTÉRIEUR : PROJECTEUR

EXTÉRIEUR : HUBLOT APPLIQUE

EXTÉRIEUR : ENCASTRÉ

DINA



40 lm

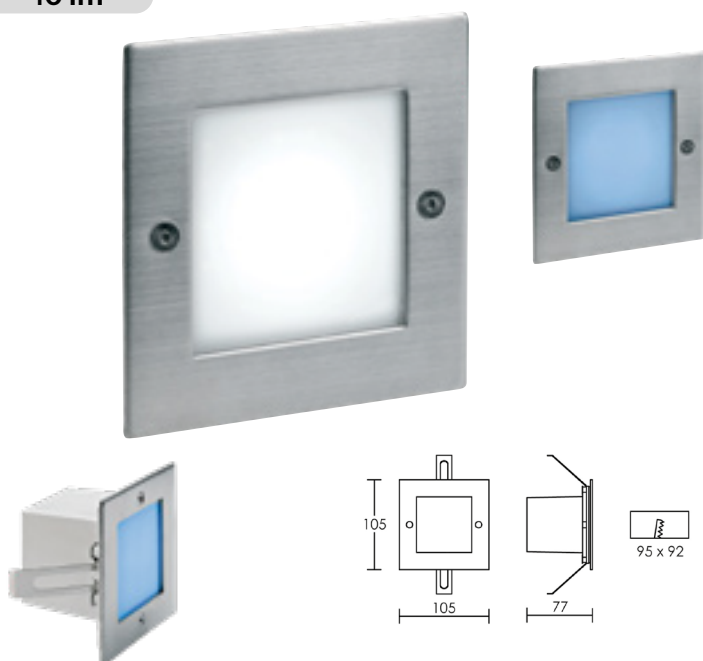

Corps aluminium/Face inox AISI 304/Diffuseur polycarbonate. Boîte d'encastrement. 1 passe-fil. Visserie inox.

| 25 000 h |        |          |             |              |
|----------|--------|----------|-------------|--------------|
| P (w)    | Lumens | Teinte   | Code        | € HT         |
| 1,5      | 40     | ○ 5000 K | <b>0508</b> | <b>50,50</b> |
| 1,5      | -      | ● bleu   | <b>0509</b> | <b>50,50</b> |

DINO



40 lm

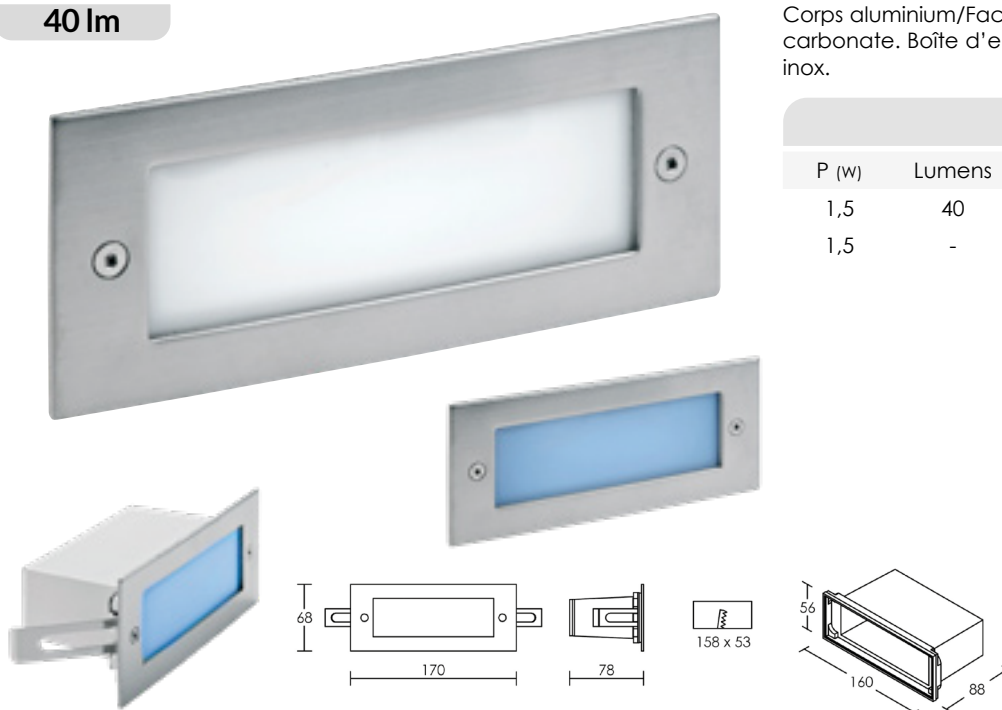

Corps aluminium/Face inox AISI 304/Diffuseur polycarbonate. Boîte d'encastrement. 1 passe-fil. Visserie inox.

| 25 000 h |        |          |             |              |
|----------|--------|----------|-------------|--------------|
| P (w)    | Lumens | Teinte   | Code        | € HT         |
| 1,5      | 40     | ○ 5000 K | <b>0514</b> | <b>50,00</b> |
| 1,5      | -      | ● bleu   | <b>0515</b> | <b>50,00</b> |

CERO



25 lm

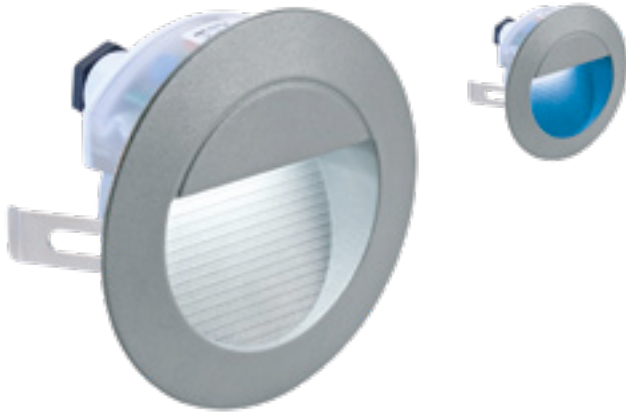

Corps et façade aluminium gris. Boîte d'encastrement. 2 presse-étoupes.

25 000 h

| P (w) | Lumens | Teinte   | Code        | € HT         |
|-------|--------|----------|-------------|--------------|
| 1,2   | 25     | ○ 5000 K | <b>0525</b> | <b>42,80</b> |
| 1,2   | -      | ● bleu   | <b>0526</b> | <b>42,80</b> |

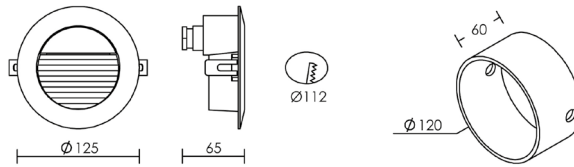

CARO



35 lm



Corps et façade aluminium gris. Boîte d'encastrement. 2 presse-étoupes.

25 000 h

| P (w) | Lumens | Teinte   | Code        | € HT         |
|-------|--------|----------|-------------|--------------|
| 1,2   | 35     | ○ 5000 K | <b>0527</b> | <b>55,10</b> |

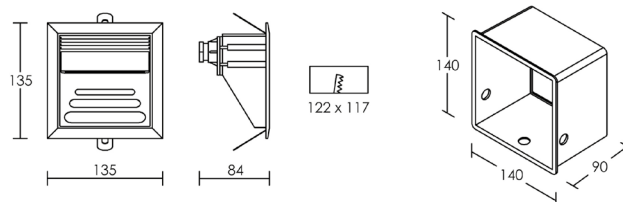

LAMPE

DOWNLIGHT ENCASTRÉ

RAIL PROJECTEUR SPOTIERIE

RÉGLIETTE

RUBAN PROFILÉ

APPLIQUE PLAFONNIER SUSPENSION

EXTÉRIEUR : PROJECTEUR

EXTÉRIEUR : HUBLOT APPLIQUE

EXTÉRIEUR : ENCASTRÉ

MURO 2



BALISAGE



Corps aluminium brossé. Boîte d'encastrement. Précâblage H05RN-F 0,3 m.

35 000 h

| P (w) | Teinte    | Couleur | Code | € HT  |
|-------|-----------|---------|------|-------|
| 0,3   | bl. froid | chromé  | 5033 | 85,20 |
| 0,3   | bleu      | chromé  | 5034 | 85,20 |

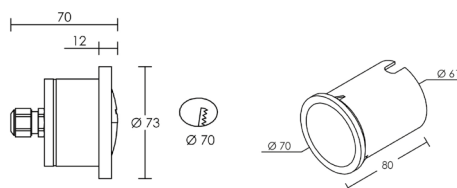

PIXEL



BALISAGE



Corps thermoplastique/Colerette aluminium. A sceller et coller. **Ne nécessite pas de boîte d'encastrement.** Installation cloison sèche. Précâblage H05RN-F 2x 1 mm<sup>2</sup> - 1,5 m, **non immergeable.**

25 000 h

| P (w) | Teinte    | Couleur | Code | € HT  |
|-------|-----------|---------|------|-------|
| 0,3   | bl. froid | gris    | 5035 | 23,80 |
| 0,3   | bleu      | gris    | 5036 | 23,80 |

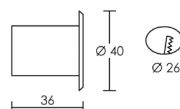



LUXMUR



Corps thermoplastique/Colerette inox. **Ne nécessite pas de boîte d'encastrement.** Câble H05RN-F 2x 1 mm<sup>2</sup> - 2 m. 1 passe-fil.

| P (w) | Douille | Couleur | Code sans lampe | € HT   |
|-------|---------|---------|-----------------|--------|
| 7     | GX53    | inox    | 1842            | 101,90 |

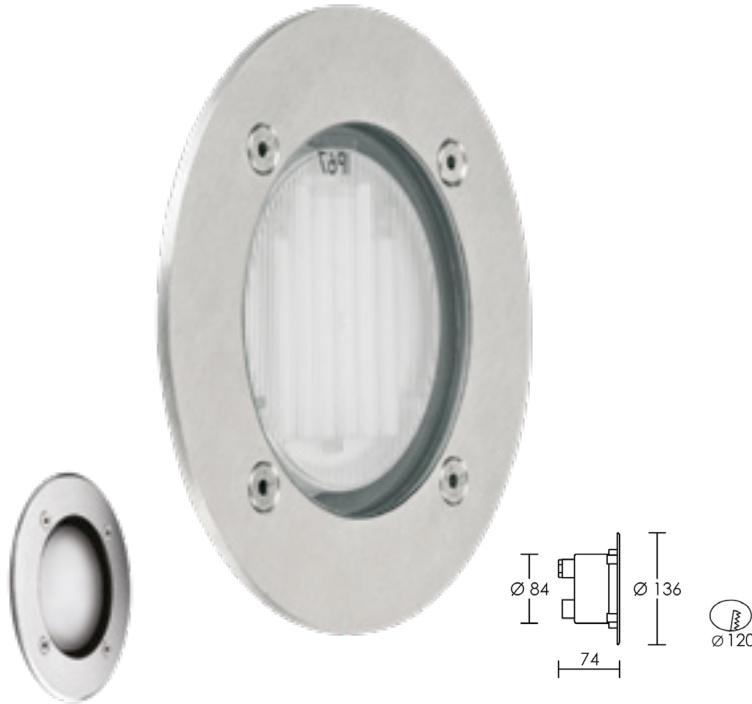

LUXMUR 2 R



Corps polycarbonate/Colerette inox 316/  
Verre trempé 4 mm. Boîte d'encastrement. 1 passe-fil.

| P (w) | Douille | Couleur | Code sans lampe | € HT   |
|-------|---------|---------|-----------------|--------|
| 7     | GX53    | inox    | 1741            | 140,60 |



LAMPE

DOWNLIGHT ENCASTRÉ

RAIL PROJECTEUR SPOTIERIE

RÉGLIETTE

RUBAN PROFILÉ

APPLIQUE PLAFONNIER SUSPENSION

EXTÉRIEUR : PROJECTEUR

EXTÉRIEUR : HUBLOT APPLIQUE

EXTÉRIEUR : ENCASTRÉ

## LUXSOL



Corps thermoplastique/Colerette inox. Boîte d'encastrement. 1 presse-étoupe. Câble H05RN-F 2x 1 mm<sup>2</sup> - 2 m.

| P (w) | Douille | Couleur  | Code sans lampe | € HT   |
|-------|---------|----------|-----------------|--------|
| 7     | GX53    | inox 304 | 1840            | 112,50 |

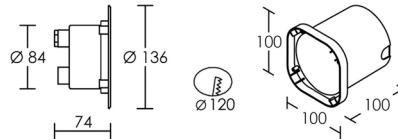

## LUXSOL 2



Corps polycarbonate/Colerette inox 316/Verre trempé 8 mm. Boîte d'encastrement. 2 presse-étoupes.

### Version R (ronde)



| P (w) | Douille | Couleur | Code sans lampe | € HT   |
|-------|---------|---------|-----------------|--------|
| 9     | GX53    | inox    | 1749            | 179,60 |

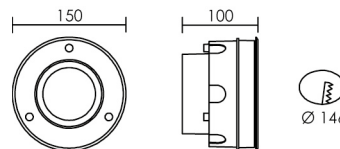

### Version C (carrée)



| P (w) | Douille | Couleur | Code sans lampe | € HT   |
|-------|---------|---------|-----------------|--------|
| 7     | GX53    | inox    | 1750            | 205,60 |

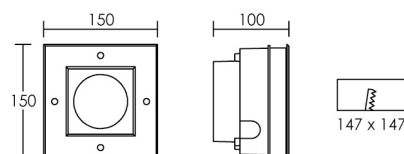

TECNISOL 150 LED



850 lm

Corps aluminium/Verre trempé transparent. **Faisceau orientable ±45° et inclinable ±12°.** Boîte d'encastrement. **Alimentation intégrée.** Précâblage H07RN-F - 2 m. 2 presse-étoupes inox. Protection thermique par fusible.

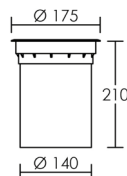

Collerette aluminium noire ronde.

| 12W      |        | 35 000 h |       |        |  |
|----------|--------|----------|-------|--------|--|
| Faisceau | Lumens | Teinte   | Code  | € HT   |  |
| 10°      | 700    | 3000 K   | 50660 | 373,30 |  |
| 10°      | 850    | 4000 K   | 50661 | 373,30 |  |
| 45°      | 650    | 3000 K   | 50662 | 373,30 |  |
| 45°      | 800    | 4000 K   | 50663 | 373,30 |  |

Collerette inox 316L ronde.

| 12W      |        | 35 000 h |       |        |  |
|----------|--------|----------|-------|--------|--|
| Faisceau | Lumens | Teinte   | Code  | € HT   |  |
| 10°      | 700    | 3000 K   | 50664 | 421,30 |  |
| 10°      | 850    | 4000 K   | 50665 | 421,30 |  |
| 45°      | 650    | 3000 K   | 50666 | 421,30 |  |
| 45°      | 800    | 4000 K   | 50667 | 421,30 |  |

Collerette inox 316L carrée.

| 12W      |        | 35 000 h |       |        |  |
|----------|--------|----------|-------|--------|--|
| Faisceau | Lumens | Teinte   | Code  | € HT   |  |
| 10°      | 700    | 3000 K   | 50668 | 430,40 |  |
| 10°      | 850    | 4000 K   | 50669 | 430,40 |  |
| 45°      | 650    | 3000 K   | 50670 | 430,40 |  |
| 45°      | 800    | 4000 K   | 50671 | 430,40 |  |

Verre de rechange, code **0248**.  
Joint de rechange, code **0280**.

50660 - 50664 - 50668

| 3000K |                       | 12 W  |  | 10° |  |
|-------|-----------------------|-------|--|-----|--|
| h (m) | E <sub>max</sub> (lx) | d (m) |  |     |  |
| 3     | 793                   | 0,7   |  |     |  |
| 2     | 3173                  | 0,3   |  |     |  |
| 1     | 12690                 | 0,2   |  |     |  |

50661 - 50665 - 50669

| 4000K |                       | 12 W  |  | 10° |  |
|-------|-----------------------|-------|--|-----|--|
| h (m) | E <sub>max</sub> (lx) | d (m) |  |     |  |
| 3     | 869                   | 0,7   |  |     |  |
| 2     | 3476                  | 0,3   |  |     |  |
| 1     | 13904                 | 0,2   |  |     |  |

50662 - 50666 - 50670

| 3000K |                       | 12 W  |  | 45° |  |
|-------|-----------------------|-------|--|-----|--|
| h (m) | E <sub>max</sub> (lx) | d (m) |  |     |  |
| 3     | 61                    | 3,3   |  |     |  |
| 2     | 244                   | 1,7   |  |     |  |
| 1     | 976                   | 0,8   |  |     |  |

50663 - 50667 - 50671

| 4000K |                       | 12 W  |  | 45° |  |
|-------|-----------------------|-------|--|-----|--|
| h (m) | E <sub>max</sub> (lx) | d (m) |  |     |  |
| 3     | 74                    | 3,3   |  |     |  |
| 2     | 296                   | 1,7   |  |     |  |
| 1     | 1185                  | 0,8   |  |     |  |



Kit d'entretien - Code 2166

- ✓ Pour conserver les caractéristiques esthétiques de l'INOX une application est préconisée tous les 6 mois
- ✓ 2 éponges de polissage + 1 agent actif

59,10 € HT

## TECNISOL 200 LED DIMMABLE



2000 lm

Corps aluminium/Verre trempé transparent. Boîte d'encastrement. **Alimentation intégrée.**  
Précâblage H07RN-F - 2 m. Protection thermique par fusible.



Collerette aluminium noire ronde.

**20W** **35 000 h**

| Faisceau | Lumens | Teinte | Code         | € HT          |
|----------|--------|--------|--------------|---------------|
| 60°      | 1850   | 3000 K | <b>50640</b> | <b>415,10</b> |
| 60°      | 2000   | 4000 K | <b>50641</b> | <b>415,10</b> |

Dimmable par coupure de phase.



Collerette inox 316L ronde.



**20W** **35 000 h**

| Faisceau | Lumens | Teinte | Code         | € HT          |
|----------|--------|--------|--------------|---------------|
| 60°      | 1850   | 3000 K | <b>50642</b> | <b>499,80</b> |
| 60°      | 2000   | 4000 K | <b>50643</b> | <b>499,80</b> |

Dimmable par coupure de phase.



Collerette inox 316L carrée.



**20W** **35 000 h**

| Faisceau | Lumens | Teinte | Code         | € HT          |
|----------|--------|--------|--------------|---------------|
| 60°      | 1850   | 3000 K | <b>50644</b> | <b>511,00</b> |
| 60°      | 2000   | 4000 K | <b>50645</b> | <b>511,00</b> |

Dimmable par coupure de phase.

Verre de rechange, code **0249**.  
Joint de rechange, code **0298**.

**50640 - 50642 - 50644**

| h (m) | E <sub>max</sub> (lx) | d (m) |
|-------|-----------------------|-------|
| 3     | 100                   | 4,6   |
| 2     | 398                   | 2,3   |
| 1     | 1592                  | 1,2   |

**50641 - 50643 - 50645**

| h (m) | E <sub>max</sub> (lx) | d (m) |
|-------|-----------------------|-------|
| 3     | 111                   | 4,6   |
| 2     | 443                   | 2,3   |
| 1     | 1770                  | 1,2   |

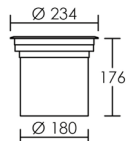

### Kit d'entretien - Code 2166



59,10 € HT

- ✓ Pour conserver les caractéristiques esthétiques de l'INOX une application est préconisée tous les 6 mois
- ✓ 2 éponges de polissage + 1 agent actif

TECNISOL 200 LED DIMMABLE ASYMÉTRIQUE



1940 lm

Corps aluminium/Verre trempé transparent. **Faisceau asymétrique orientable ±17,5°**. Boîte d'encastrement. **Alimentation intégrée**. Précâblage H07RN-F - 2 m. Protection thermique par fusible.



Collerette aluminium noire ronde.

| 20W         |        | 35 000 h |       |        |  |
|-------------|--------|----------|-------|--------|--|
| Faisceau    | Lumens | Teinte   | Code  | € HT   |  |
| 45° Asy 15° | 1860   | 3000 K   | 50646 | 454,90 |  |
| 45° Asy 15° | 1940   | 4000 K   | 50647 | 454,90 |  |

Dimmable par coupure de phase.

Collerette inox 316L ronde.



| 20W         |        | 35 000 h |       |        |  |
|-------------|--------|----------|-------|--------|--|
| Faisceau    | Lumens | Teinte   | Code  | € HT   |  |
| 45° Asy 15° | 1860   | 3000 K   | 50648 | 539,60 |  |
| 45° Asy 15° | 1940   | 4000 K   | 50649 | 539,60 |  |

Dimmable par coupure de phase.

Collerette inox 316L carrée.



| 20W         |        | 35 000 h |       |        |  |
|-------------|--------|----------|-------|--------|--|
| Faisceau    | Lumens | Teinte   | Code  | € HT   |  |
| 45° Asy 15° | 1860   | 3000 K   | 50650 | 550,80 |  |
| 45° Asy 15° | 1940   | 4000 K   | 50651 | 550,80 |  |

Dimmable par coupure de phase.

Verre de rechange, code **0249**.  
Joint de rechange, code **0298**.

50646 - 50648 - 50650

| h (m) | E <sub>max</sub> (lx) | d (m) |
|-------|-----------------------|-------|
| 3     | 134                   | 3,3   |
| 2     | 536                   | 1,7   |
| 1     | 2143                  | 0,8   |

50647 - 50649 - 50651

| h (m) | E <sub>max</sub> (lx) | d (m) |
|-------|-----------------------|-------|
| 3     | 144                   | 3,3   |
| 2     | 578                   | 1,7   |
| 1     | 2310                  | 0,8   |



Aide à la pose pour un effet réussi

Soit (a) le recul par rapport au mur et (d) l'espacement entre encastrés :

- ✓ pour bien délimiter en hauteur la zone que l'on souhaite souligner :  $a = 1/3h$
- ✓ pour une bonne uniformité dans la longueur, il faut :  $e \leq 1,25a$

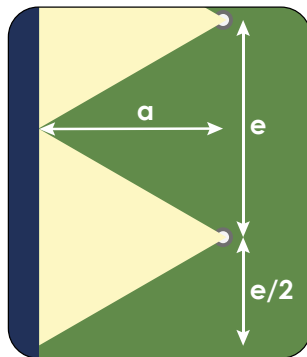
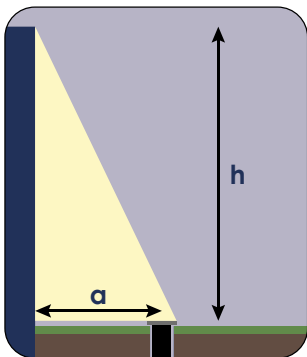

## MIRA 65 - 24



305 lm

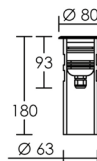

Corps et collerette aluminium anodisé/Vis inox.  
Sans alimentation. **TBT 24V**. Précâblage H05RN-F - 1 m.  
Boîte d'encastrement thermoplastique.

5W  $\triangleleft$  34° 30 000 h

| Lumens | Teinte | Couleur | Code         | € HT          |
|--------|--------|---------|--------------|---------------|
| 305    | 3000 K | noir    | <b>50287</b> | <b>188,70</b> |
| 305    | 3000 K | gris    | <b>50288</b> | <b>188,70</b> |

| MIRA 65 | 3000K | 5 W                   | 34°   |
|---------|-------|-----------------------|-------|
| 24      | h (m) | E <sub>max</sub> (lx) | d (m) |
|         | 3     | 44                    | 2,4   |
|         | 2     | 175                   | 1,2   |
|         | 1     | 700                   | 0,6   |

## MIRA 65 - 230



214 lm

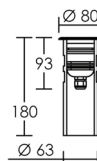

Corps et collerette aluminium anodisé/Vis inox.  
**Alimentation intégrée. Direct 230V**. Précâblage H05RN-F - 1 m.  
Boîte d'encastrement thermoplastique.

5W  $\triangleleft$  35° 35 000 h

| Lumens | Teinte | Couleur | Code         | € HT          |
|--------|--------|---------|--------------|---------------|
| 214    | 3000 K | noir    | <b>50285</b> | <b>211,10</b> |
| 214    | 3000 K | gris    | <b>50286</b> | <b>211,10</b> |

| MIRA 65 | 3000K | 5 W                   | 35°   |
|---------|-------|-----------------------|-------|
| 230     | h (m) | E <sub>max</sub> (lx) | d (m) |
|         | 3     | 33                    | 2,5   |
|         | 2     | 131                   | 1,3   |
|         | 1     | 525                   | 0,6   |

## MIRA 45 - 24

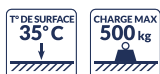

102 lm

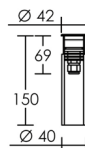

Corps et collerette aluminium anodisé/Vis inox.  
Sans alimentation. **TBT 24V**. Précâblage H05RN-F - 1 m.  
Boîte d'encastrement thermoplastique.

2W  $\triangleleft$  34° 35 000 h

| Lumens | Teinte | Couleur | Code         | € HT          |
|--------|--------|---------|--------------|---------------|
| 102    | 3000 K | gris    | <b>50289</b> | <b>114,20</b> |

| MIRA 45 | 3000K | 2 W                   | 34°   |
|---------|-------|-----------------------|-------|
| 24      | h (m) | E <sub>max</sub> (lx) | d (m) |
|         | 3     | 17                    | 2,4   |
|         | 2     | 69                    | 1,2   |
|         | 1     | 276                   | 0,6   |

MIRA 65



**BALISAGE**

Corps et collerette aluminium anodisé/Vis inox. **Alimentation intégrée. Direct 230V.** Précâblage H05RN-F - 1 m. Boîte d'encastrement thermoplastique.

**Version B1**

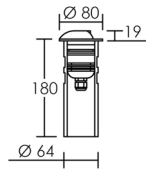

30 000 h

| P (W) | Teinte | Couleur | Code  | € HT   |
|-------|--------|---------|-------|--------|
| 5     | 3000 K | inox    | 50611 | 197,90 |

**Version B2**

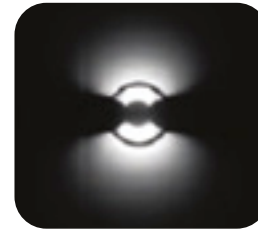
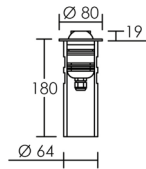

30 000 h

| P (W) | Teinte | Couleur | Code  | € HT   |
|-------|--------|---------|-------|--------|
| 5     | 3000 K | inox    | 50612 | 209,10 |

**Version B4**

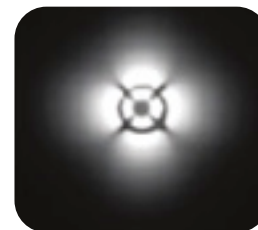
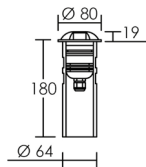

30 000 h

| P (W) | Teinte | Couleur | Code  | € HT   |
|-------|--------|---------|-------|--------|
| 5     | 3000 K | inox    | 50613 | 209,10 |

LAMPE

DOWNLIGHT ENCASTRÉ

RAIL PROJECTEUR SPOTIERIE

RÉGLIETTE

RUBAN PROFILÉ

APPLIQUE PLAFONNIER SUSPENSION

EXTÉRIEUR : PROJECTEUR

EXTÉRIEUR : HUBLOT APPLIQUE

EXTÉRIEUR : ENCASTRÉ

AQUASOL MINI LED



280 lm

Corps aluminium/Colerette inox 304. Source orientable +/- 15°. Boîte d'encastrement. **Alimentation intégrée.** Précâblage H07RN-F - 2x 1mm<sup>2</sup> - 3 m. Protection thermique par fusible. 1 presse-étoupe.

Version R (ronde)

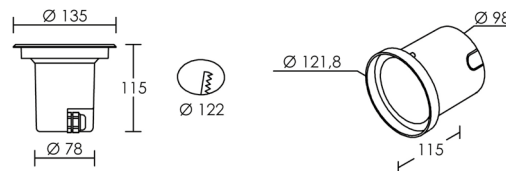

30 000 h

| P (w) | Lumens | Teinte      | Code | € HT   |
|-------|--------|-------------|------|--------|
| 3x 1  | 280    | ● bl. froid | 5137 | 204,70 |
| 3x 1  | -      | ● bleu      | 5138 | 187,80 |

Version C (carrée)

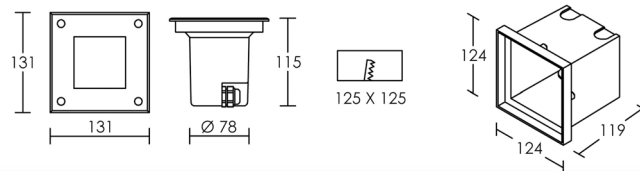

30 000 h

| P (w) | Lumens | Teinte      | Code | € HT   |
|-------|--------|-------------|------|--------|
| 3x 1  | 280    | ● bl. froid | 5139 | 246,10 |
| 3x 1  | -      | ● bleu      | 5140 | 225,90 |



59,10 € HT

Kit d'entretien - Code 2166



- ✓ Pour conserver les caractéristiques esthétiques de l'INOX une application est préconisée tous les 6 mois
- ✓ 2 éponges de polissage + 1 agent actif



ENZO B4



BALISAGE

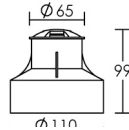

Corps aluminium/Colerette inox. Boîte d'encastrement. Précâblage H05RN-F - 1,5 m.

| P (W) | Lumens | Teinte | Code | € HT  |
|-------|--------|--------|------|-------|
| 0,6   | -      | bleu   | 5313 | 79,10 |

Alimentation p. 427.



LAMPE

DOWNLIGHT ENCASTRÉ

RAIL PROJECTEUR SPOTERIE

RÉGLIETTE

RUBAN PROFILÉ

APPLIQUE PLAFONNIER SUSPENSION

EXTÉRIEUR : PROJECTEUR

EXTÉRIEUR : HUBLOT APPLIQUE

EXTÉRIEUR : ENCASTRÉ

## EGO



### BALISAGE

Corps thermoplastique/Colerette inox 304. Boîte d'encastrement. Utiliser du câble H05RN-F 2x 0,75 mm<sup>2</sup>.

### Version R (ronde)

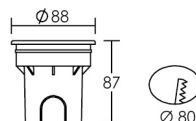

30 000 h

| P (w) | Teinte | Couleur | Code | € HT  |
|-------|--------|---------|------|-------|
| 1,5   | 3500 K | inox    | 1757 | 71,00 |
| 1,5   | bleu   | inox    | 1758 | 71,00 |

Pot de rechange, code 0390.

### Version C (carrée)

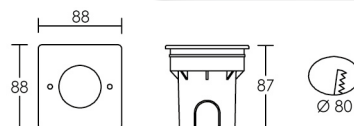

30 000 h

| P (w) | Teinte | Couleur | Code | € HT  |
|-------|--------|---------|------|-------|
| 1,5   | 3500 K | inox    | 1814 | 72,70 |
| 1,5   | bleu   | inox    | 1815 | 72,70 |

Pot de rechange, code 0390.

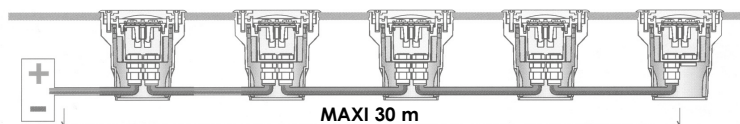

Maximum 14 appareils branchés au transformateur/alimentation pour une distance max de 30 mètres. Utiliser du câble H05RN-F 2x 0,75 mm<sup>2</sup> Ø7 mm maxi., code 0946, pour installation dans le sol.

### ALIMENTATIONS



24V DC

| Nb appareils | IP | P (w) | Code  | € HT  |
|--------------|----|-------|-------|-------|
| 1 à 10       | 20 | 20    | 52005 | 38,20 |
| 1 à 15       | 67 | 30    | 0695  | 52,60 |

Détails p. 428

AQUASOL MICRO



Corps aluminium. Boîte d'encastrement. Précâblage H05RN-F - 2x 1 mm<sup>2</sup> - 1,5 m. 1 presse-étoupe.  
**Température contact : halogène 115°C - LED 30°C.**

Version inox

Collerette inox 304.

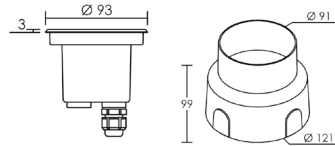

| P (w) | Douille | Couleur | Code sans lampe | € HT  |
|-------|---------|---------|-----------------|-------|
| 20    | G4      | inox    | 4630            | 95,70 |

Version B1

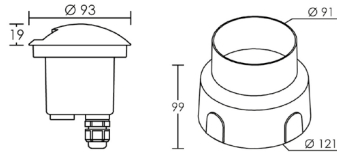

| P (w) | Douille | Couleur   | Code sans lampe | € HT  |
|-------|---------|-----------|-----------------|-------|
| 20    | G4      | gris alu. | 4631            | 79,20 |

Version B4

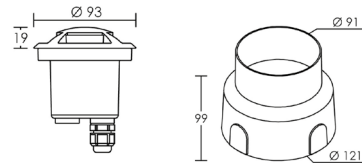

| P (w) | Douille | Couleur   | Code sans lampe | € HT  |
|-------|---------|-----------|-----------------|-------|
| 20    | G4      | gris alu. | 4633            | 79,20 |

Lampe adaptée à ces appareils (p. 31) :

G4 - LED 1W



130 lm

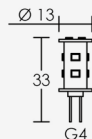
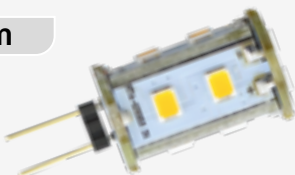

Lampe G4 circuit apparent.

| P (w) | Culot | Lumens | Teinte   | Code | € HT  |
|-------|-------|--------|----------|------|-------|
| 1     | G4    | 130    | ● 3000 K | 2566 | 13,70 |
| 1     | G4    | 130    | ○ 4000 K | 2567 | 13,70 |

LAMPE

DOWNLIGHT ENCASTRÉ

RAIL PROJECTEUR SPOTIERIE

RÉGLIETTE

RUBAN PROFILÉ

APPLIQUE PLAFONNIER SUSPENSION

EXTÉRIEUR : PROJECTEUR

EXTÉRIEUR : HUBLOT APPLIQUE

EXTÉRIEUR : ENCASTRÉ

AQUASOL MINI



Corps aluminium/Colerette inox 304. Boîte d'encastrement. 1 presse-étoupe.  
**Température contact : halogène 100°C - LED 35°C.**

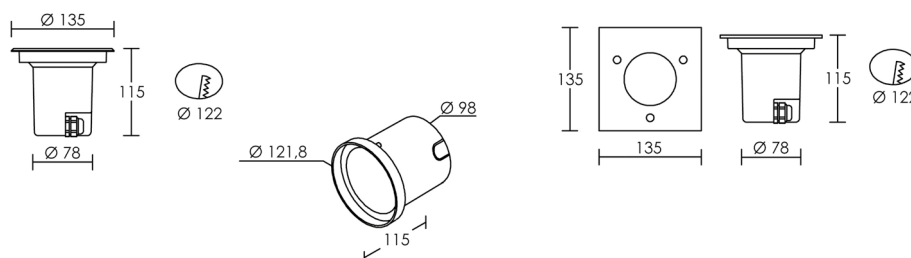

Boîte d'encastrement commune aux 2 modèles

Version GU5,3 - Sans lampe



Précâblage H05RN-F - 2x 1 mm<sup>2</sup> - 1,5 m.

| P (w) | Douille | Colerette | Code sans lampe | € HT          |
|-------|---------|-----------|-----------------|---------------|
| 35    | GU5,3   | ronde     | <b>4666</b>     | <b>126,40</b> |
| 35    | GU5,3   | carrée    | <b>4667</b>     | <b>132,40</b> |



Version GU10 - Sans lampe



Précâblage H05RN-F - 3G 1 mm<sup>2</sup> - 1,5 m.

| P (w) | Douille | Colerette | Code sans lampe | € HT          |
|-------|---------|-----------|-----------------|---------------|
| 35    | GU10    | ronde     | <b>4648</b>     | <b>132,40</b> |
| 35    | GU10    | carré     | <b>4649</b>     | <b>144,20</b> |



AQUASOL MINI



Corps aluminium. Boîte d'encastrement. Précâblage H05RN-F - 3G 1mm<sup>2</sup> - 1,5 m. 1 presse-étoupe.  
**Température contact : halogène 140°C - LED 30°C.**

Version B1



| P (W) | Douille | Couleur   | Code sans lampe | € HT   |
|-------|---------|-----------|-----------------|--------|
| 35    | GU10    | gris alu. | 4655            | 132,40 |

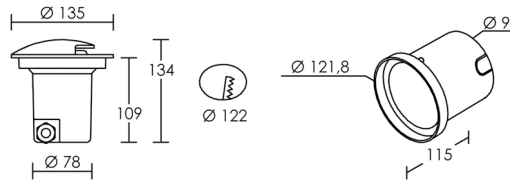

Version B2



| P (W) | Douille | Couleur   | Code sans lampe | € HT   |
|-------|---------|-----------|-----------------|--------|
| 35    | GU10    | gris alu. | 4661            | 132,40 |

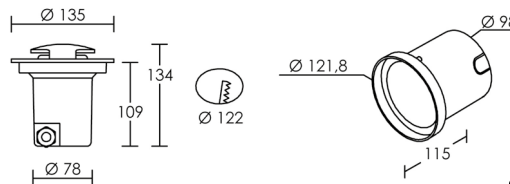

LAMPE

DOWNLIGHT ENCASTRÉ

RAIL PROJECTEUR SPOTIERIE

RÉGLIETTE

RUBAN PROFILÉ

APPLIQUE PLAFONNIER SUSPENSION

EXTÉRIEUR : PROJECTEUR

EXTÉRIEUR : HUBLOT APPLIQUE

EXTÉRIEUR : ENCASTRÉ

## WALKER 1

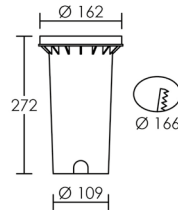

Corps thermoplastique/Ecran polycarbonate/Verre interne opale. Boîte d'encastrement. 1 presse-étoupe.

| P (w) | Douille | Couleur | Code sans lampe | € HT  |
|-------|---------|---------|-----------------|-------|
| 40    | E27     | satiné  | 1748            | 68,10 |

Ecran de rechange, code **0939**.

## WALKER 2



Corps thermoplastique/Ecran polycarbonate/Verre interne opale. Boîte d'encastrement. 1 presse-étoupe. Colerette inox 304, épaisseur 3 mm.

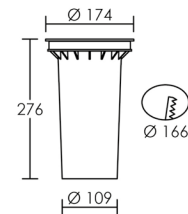

### Sans lampe



| P (w) | Douille | Couleur | Code sans lampe | € HT   |
|-------|---------|---------|-----------------|--------|
| 40    | E27     | inox    | 1752            | 106,70 |

Ecran de rechange, code **1229**.

\* Lampe R63 si halogène - R80 si LED.

### Avec lampe réflecteur Ø80 LED



810 lm



| P (w) | Lumens | Teinte | Code | € HT   | 35 000 h |
|-------|--------|--------|------|--------|----------|
| 11    | 810    | 2700 K | 1857 | 100,00 |          |

WALKER 3



Corps thermoplastique/Ecran polycarbonate/Verre interne opale. Boîte d'encastrement. 1 presse-étoupe. Colletette inox 304, épaisseur 5 mm.

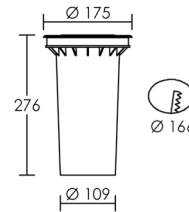

Sans lampe



| P (w) | Douille | Couleur | Code sans lampe | € HT   |
|-------|---------|---------|-----------------|--------|
| 40    | E27     | inox    | 1700            | 119,50 |

Ecran de rechange, code 1216.  
\* Lampe R63 si halogène - R80 si LED.

Avec lampe réflecteur Ø80 LED



810 lm



| P (w) | Lumens | Teinte | Code | € HT   |
|-------|--------|--------|------|--------|
| 11    | 810    | 2700 K | 1855 | 172,70 |

35 000 h

AQUASOL MEDIUM



Corps aluminium/Colletette inox 304. Boîte d'encastrement. Transformateur intégré. Précâblage H05RN-F - 3G 1 mm² - 1,5 m. 1 presse-étoupe. Lampe orientable 15°.

| P (w) | Douille | Couleur | Code sans lampe | € HT   |
|-------|---------|---------|-----------------|--------|
| 50    | G53     | inox    | 1720            | 299,20 |

Joint et verre de rechange, code 0938.  
Transformateur de rechange, code 1222.

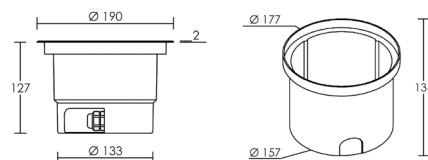

**COLOREYE CS RGB**



**BALISAGE**



Encastré de sol. Corps inox 316 brossé. Précâblage, 2 câbles 0,8 m, avec connecteur. **Applications intérieures uniquement** sur supports : moquette, parquet, carrelage, menuiserie. Changement de couleur, programme pré-installé avec cycle de 10 minutes, une couleur mémorisable.

**50 000 h**

| P (w) | Teinte | Couleur | Code | € HT  |
|-------|--------|---------|------|-------|
| 0,46  | RGB    | inox    | 5639 | 80,70 |

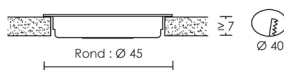
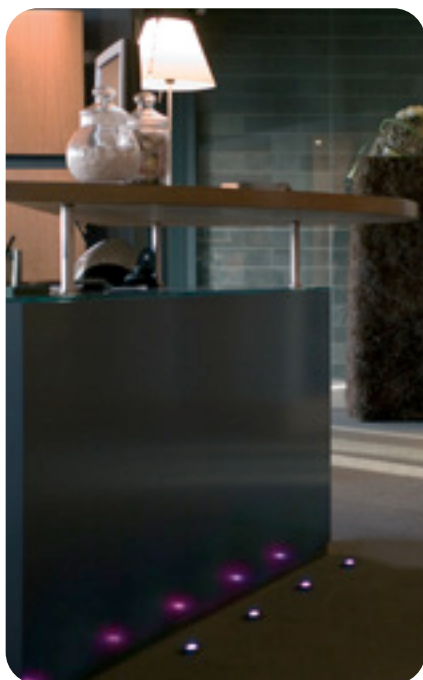

**ACCESSOIRES**



| Désignation                           | Code | € HT  |
|---------------------------------------|------|-------|
| Alimentation 10W (pour 20 spots max.) | 5518 | 84,50 |
| Séquenceur RGB                        | 5675 | 74,50 |

Autres accessoires p. 385.

**PROGRAMMATION RGB**

**Programme 1** : changement de couleur



**Programme 2** : fixer une couleur

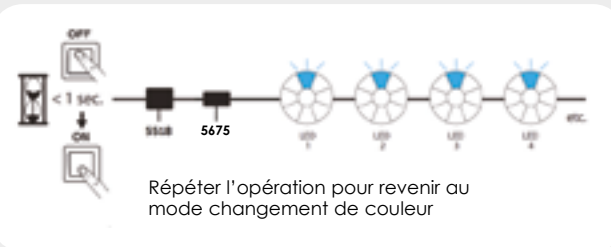

**SCHÉMAS DE RACCORDEMENT**

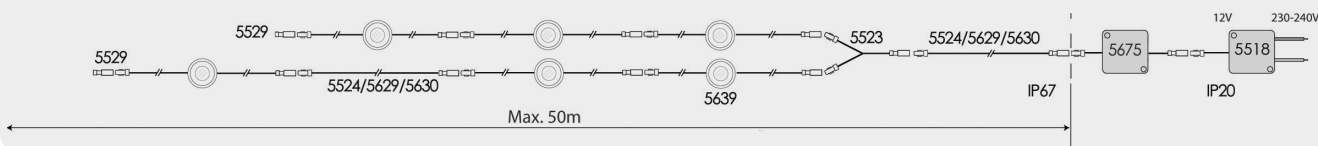



EYELEDS INDOOR



BALISAGE



Encastré de sol. Corps inox 316 brossé. Précâblage, 2 câbles 2x 0,80 m, avec connecteur. **Applications intérieures uniquement** : moquette, parquet, sol plastique, menuiserie.

50 000 h

| Version | P (W) | Teinte | Code | € HT  |
|---------|-------|--------|------|-------|
| ronde   | 0,3   | 2700 K | 5667 | 80,70 |
| ronde   | 0,3   | 5500 K | 5500 | 80,70 |
| ronde   | 0,3   | bleu   | 5501 | 80,70 |
| ronde   | 0,3   | ambre  | 5502 | 80,70 |
| carrée  | 0,6   | 2700 K | 5668 | 89,30 |
| carrée  | 0,6   | 5500 K | 5512 | 89,30 |
| carrée  | 0,6   | bleu   | 5513 | 89,30 |
| carrée  | 0,6   | ambre  | 5514 | 89,30 |

ACCESSOIRES Gammes EYELEDS INDOOR, ColorEYE CS

| Désignation   | Code | € HT  |
|---|------|-------|
| Alim. encastrable, 12W, Ø60 x P25 mm max. 40 spots ronds, 20 carrés ou 8 PowerEYE | 5518 | 84,50 |
| Alim. fiche, 5W, max. 12 spots ronds, 8 carrés ou 3 PowerEYE                      | 5520 | 43,70 |
| Câble de prolongation 6 m   | 5524 | 26,20 |
| Câble de prolongation 3 m   | 5629 | 23,10 |
| Câble de prolongation 1 m   | 5630 | 19,00 |
| Connecteur en T long. 120   | 5523 | 27,60 |
| Embout isolation IP67 nécessaire en fin de ligne                                  | 5529 | 10,20 |

SCHÉMAS DE RACCORDEMENT

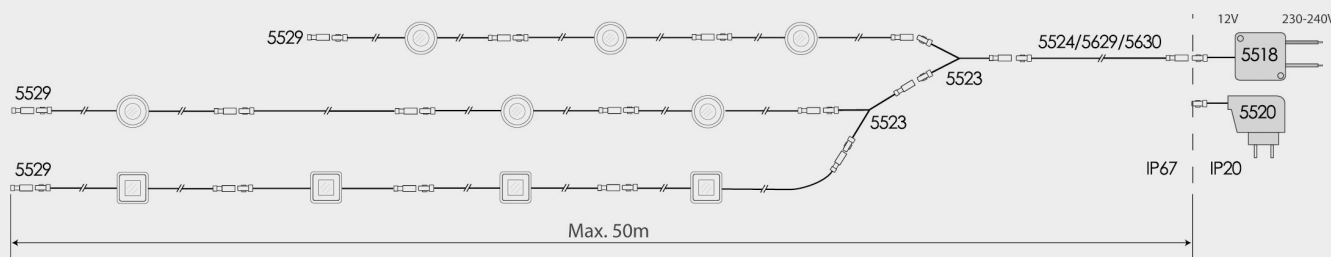

EYELEDS OUTDOOR STANDARD



BALISAGE

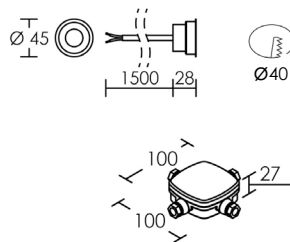

Encastré de sol. Corps inox 316 brossé. Applications extérieures sur terrasse bois, dallage. Précâblage H05RN-F - 1,5 m. Boîte de dérivation.

| 50 000 h |            |         |             |              |
|----------|------------|---------|-------------|--------------|
| P (w)    | Teinte     | Couleur | Code        | € HT         |
| 0,3      | ● bl.chaud | inox    | <b>5687</b> | <b>83,20</b> |
| 0,3      | ● bl.froid | inox    | <b>5688</b> | <b>83,20</b> |
| 0,3      | ● bleu     | inox    | <b>5689</b> | <b>83,20</b> |



Boîte de dérivation

ACCESSOIRES



| Désignation   | Code        | € HT         |
|---|-------------|--------------|
| Alimentation 230/12V DC 12W<br>IP67 (pour 40 spots max.)<br>Précâblage 1,20 m<br>au primaire, 3,5 m<br>au secondaire. | <b>5593</b> | <b>72,80</b> |
| Câble 10 m H05RNF 2x 1 mm <sup>2</sup>  | <b>5594</b> | <b>58,20</b> |

SCHÉMAS DE RACCORDEMENT

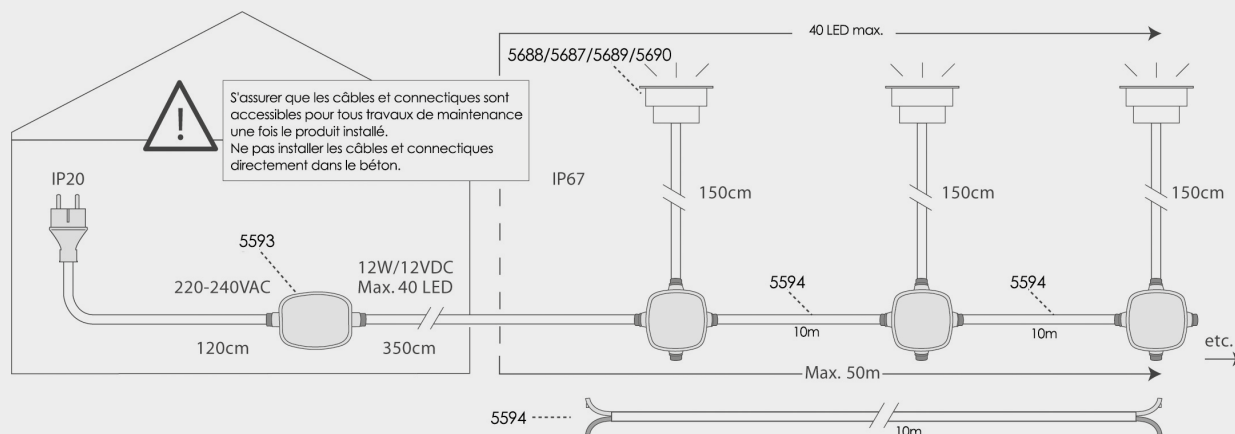

EYELEDS OUTDOOR PRO



BALISAGE



Encastré de sol. Corps inox 316 brossé. Connecteur rapide M12. Câble H05BQ-F anti UV haute qualité. Applications extérieures sur terrasse bois, dallage.

50 000 h

| P (w) | Teinte   | Couleur | Code | € HT   |
|-------|----------|---------|------|--------|
| 0,3   | bl.chaud | inox    | 5694 | 100,30 |
| 0,3   | bl.froid | inox    | 5695 | 100,30 |
| 0,3   | bleu     | inox    | 5696 | 100,30 |

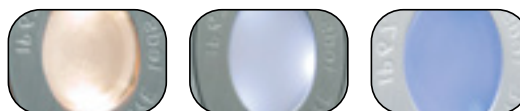
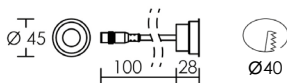

ACCESSOIRES

| Désignation   | Code | € HT   |
|---|------|--------|
| Alimentation classe 2 230/12V DC 12W IP66 (pour 40 spots max.)<br>Précâblage 1,20 m au primaire, 3,5 m au secondaire. | 5600 | 201,00 |
| Rallonge 500 cm   | 5603 | 84,50  |
| Rallonge 200 cm   | 5604 | 72,80  |
| Connecteur en T 30/30 cm  | 5602 | 81,60  |
| Connecteur en T 60/60 cm  | 5666 | 87,40  |
| Connecteur en T 30/150 cm   | 5601 | 94,70  |

SCHÉMAS DE RACCORDEMENT

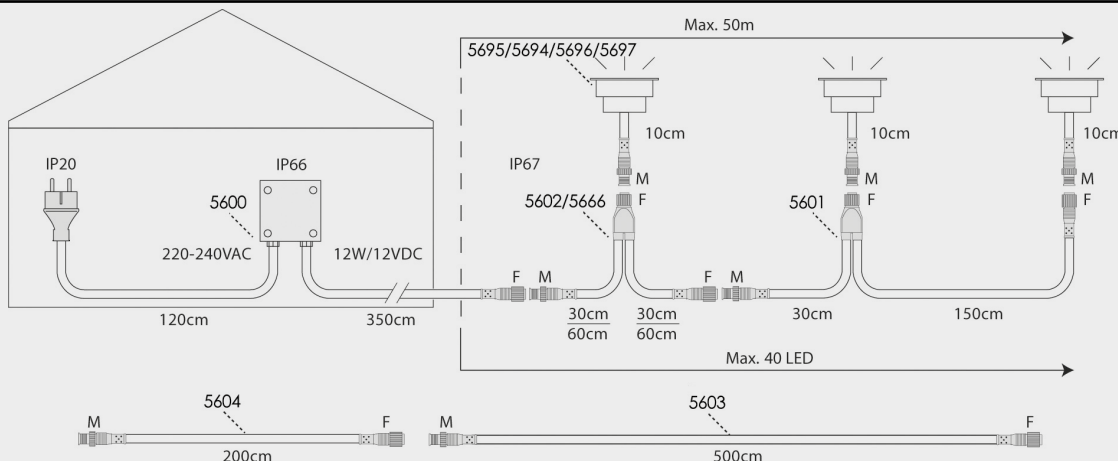

KIT DEAUVILLE



96 lm



Corps aluminium, 6 spots - 3W - IP65 cloison sèche et plancher. Prêt-à-poser, précâblage 2 m avec connecteur. Ballast ferromagnétique 12V, classe 2, IP44, câble 1 m. Fiche 16A, câble 2 m. Dérivation IP44 6 départs.

50 000 h

| P (w)  | Lumens | Teinte | Code | € HT   |
|--------|--------|--------|------|--------|
| 6x 0,5 | 96     | 6500 K | 5046 | 221,10 |
| 6x 0,5 | -      | bleu   | 5047 | 221,10 |

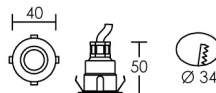

## PIXO

IRC  
>80

230V

IP  
54

650°C

800 lm

Corps aluminium extrudé anthracite/Diffuseur PMMA givré. Livré avec 3 tiges de fixation. **Alimentation intégrée.**

◀ 110°

25 000 h

| P (w)         | Lumens | Teinte   | Code         | € HT          |
|---------------|--------|----------|--------------|---------------|
| <b>N</b> 12,5 | 800    | ● 3000 K | <b>50814</b> | <b>125,00</b> |

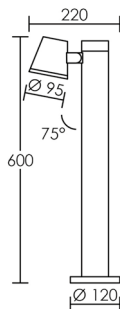

LAMPE

DOWNLIGHT  
ENCASTRERAIL  
PROJECTEUR  
SPOTIERE

RÉGLIETTE

RUBAN  
PROFILÉAPPLIQUE  
PLAFONNIER  
SUSPENSIONEXTÉRIEUR :  
PROJECTEUREXTÉRIEUR :  
HUBLOT  
APPLIQUEEXTÉRIEUR :  
ENCASTRE

KEELER



295 lm

Corps en aluminium extrudé graphite/Diffuseur polycarbonate transparent. Alimentation intégrée.

Version 9

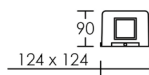

Montage en applique ou au sol.

| ◀ 50° |        | 25 000 h |       |        |
|-------|--------|----------|-------|--------|
| P (w) | Lumens | Teinte   | Code  | € HT   |
| 8     | 295    | ● 3000 K | 50278 | 262,10 |

Version 35

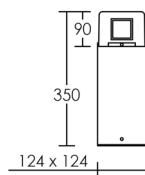

Eclairage dirigé vers le sol : 1 direction.

| ◀ 50° |        | 25 000 h |       |        |
|-------|--------|----------|-------|--------|
| P (w) | Lumens | Teinte   | Code  | € HT   |
| 8     | 280    | ● 3000 K | 50272 | 372,30 |

ACCESSOIRE



| Désignation                         | Code  | € HT  |
|-------------------------------------|-------|-------|
| fixation pour KEELER 9 et KEELER 35 | 50283 | 39,80 |



STICK



210 lm

Corps en aluminium extrudé graphite/Diffuseur polycarbonate transparent. Eclairage dirigé vers le sol.

Version 40 asymétrique

Eclairage 1 direction.

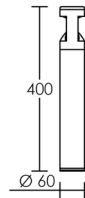

| 25 000 h |        |        |       |        |
|----------|--------|--------|-------|--------|
| P (W)    | Teinte | Lumens | Code  | € HT   |
| 7        | 3000 K | 210    | 50273 | 284,60 |

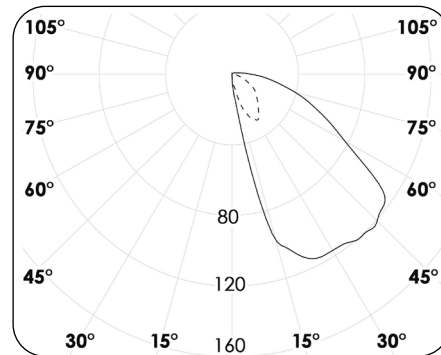

CD/klm  
C0 - C180 --- C90 - C270  $\eta = 100\%$

Version 60 double asymétrique

Eclairage 2 directions.

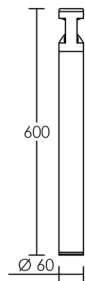

| 25 000 h |        |        |       |        |
|----------|--------|--------|-------|--------|
| P (W)    | Teinte | Lumens | Code  | € HT   |
| 7        | 3000 K | 210    | 50274 | 294,80 |

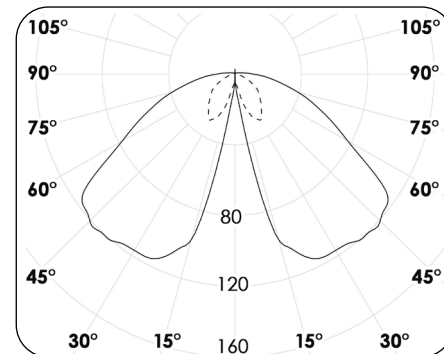

CD/klm  
C0 - C180 --- C90 - C270  $\eta = 100\%$



40 asymétrique



60 double asymétrique

ACCESSOIRE



| Désignation                        | Code  | € HT  |
|------------------------------------|-------|-------|
| fixation pour STICK 40 et STICK 60 | 50284 | 39,80 |

LAMPE

DOWNLIGHT ENCASTRE

RAIL PROJECTEUR SPOTIERIE

RÉGLIETTE

RUBAN PROFILÉ

APPLIQUE PLAFONNIER SUSPENSION

EXTÉRIEUR : PROJECTEUR

EXTÉRIEUR : HUBLOT APPLIQUE

EXTÉRIEUR : BORNE

MORPHIS



1700 lm



Corps aluminium extrudé graphite/Diffuseur polycarbonate transparent. **LED CITIZEN. Alimentation intégrée.** Trappe de visite pour raccordement.

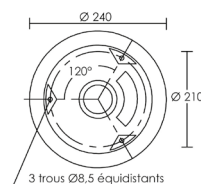
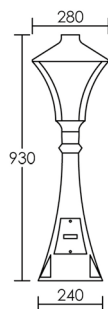

Fixation béton incluse

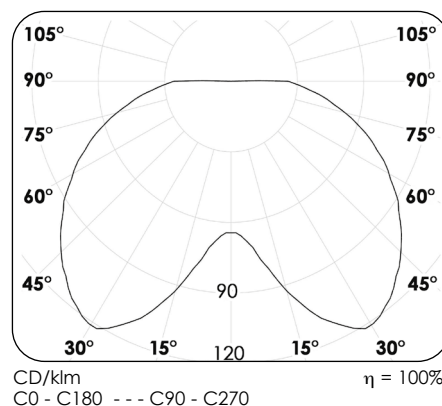

ACCESSOIRE



| Désignation      | Code | € HT  |
|------------------|------|-------|
| Raccord 3 câbles | 0739 | 31,40 |





## SUNNY



845 lm

Corps aluminium extrudé graphite/Diffuseur polycarbonate opale. **LED SÉOUL. Alimentation intégrée.**

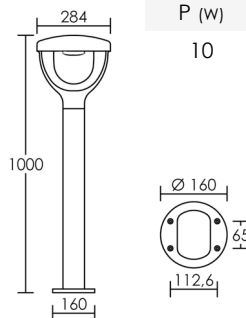

30 000 h

| P (w) | Lumens | Teinte   | Code         | € HT          |
|-------|--------|----------|--------------|---------------|
| 10    | 845    | ○ 4000 K | <b>50298</b> | <b>636,50</b> |

## ACCESSOIRES



| Désignation      | Code        | € HT         |
|------------------|-------------|--------------|
| Raccord 3 câbles | <b>0739</b> | <b>31,40</b> |



| Désignation | Code         | € HT         |
|-------------|--------------|--------------|
| Fixation    | <b>50299</b> | <b>51,00</b> |

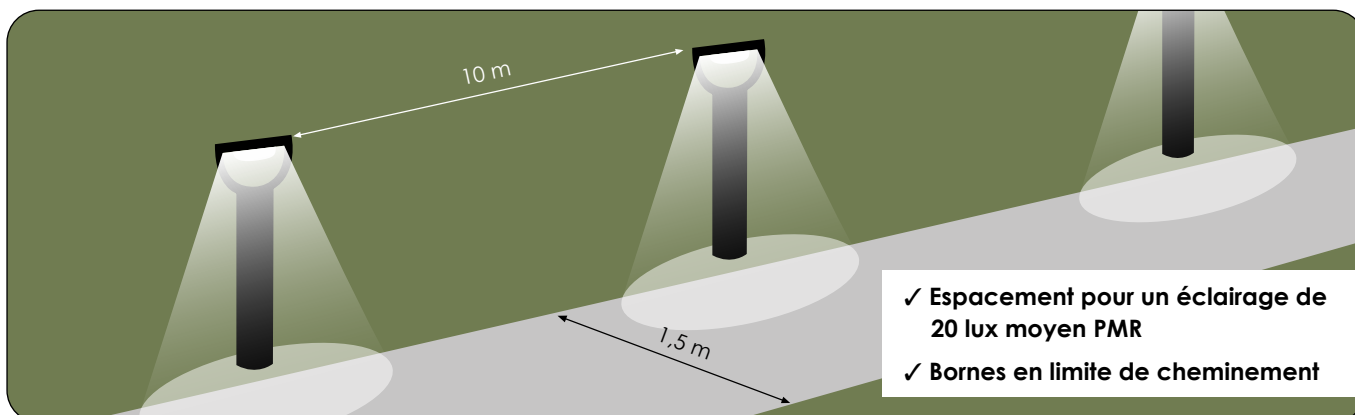

NEWAY LED



800 lm

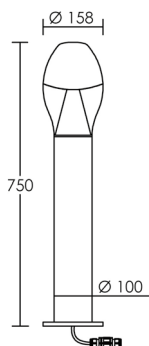

Corps aluminium extrudé/Diffuseur polycarbonate transparent. **LED SMD CITIZEN**. Précâblée avec raccord, code **0743**, IP68.

10W 30 000 h

| Lumens | Teinte   | Couleur  | Code         | € HT          |
|--------|----------|----------|--------------|---------------|
| 800    | ○ 4000 K | graphite | <b>50300</b> | <b>452,90</b> |



ACCESSOIRES



| Désignation      | Code        | € HT         |
|------------------|-------------|--------------|
| Raccord 3 câbles | <b>0739</b> | <b>31,40</b> |



| Désignation | Code        | € HT         |
|-------------|-------------|--------------|
| Fixation    | <b>0575</b> | <b>58,90</b> |

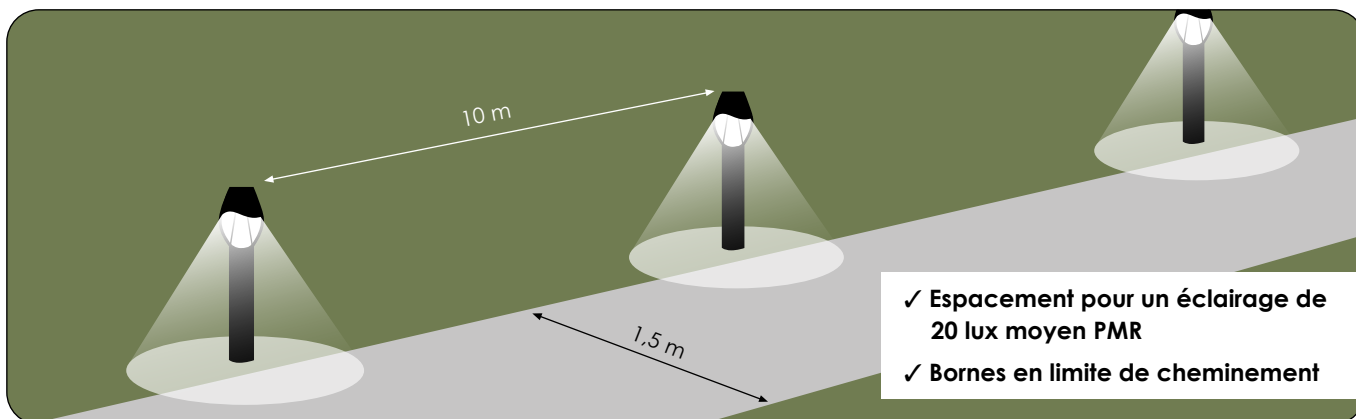

- ✓ Espacement pour un éclairage de 20 lux moyen PMR
- ✓ Bornes en limite de cheminement

NEWAY



Corps aluminium extrudé/Diffuseur polycarbonate. Précâblée avec raccord, code **0743**, IP68.  
Lampe E27 diamètre maxi 55 mm.

## Version borne basse

| P (w) | Douille | Couleur  | Code sans lampe | € HT          |
|-------|---------|----------|-----------------|---------------|
| 75    | E27     | graphite | <b>4020</b>     | <b>313,10</b> |

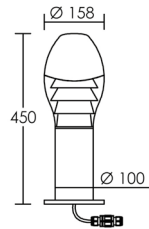

## Version borne haute

| P (w) | Douille | Couleur   | Code sans lampe | € HT          |
|-------|---------|-----------|-----------------|---------------|
| 75    | E27     | graphite  | <b>4021</b>     | <b>335,70</b> |
| 75    | E27     | gris alu. | <b>4023</b>     | <b>335,70</b> |

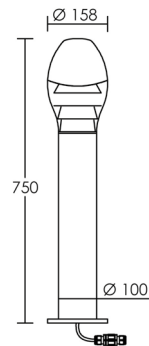

Borne basse



Borne haute



LED p. 20

## ACCESSOIRES



| Désignation      | Code        | € HT         |
|------------------|-------------|--------------|
| Raccord 3 câbles | <b>0739</b> | <b>31,40</b> |



| Désignation | Code        | € HT         |
|-------------|-------------|--------------|
| Fixation    | <b>0575</b> | <b>58,90</b> |

LAMPE

DOWNLIGHT  
ENCASTRERAIL  
PROJECTEUR  
SPOTERIE

RÉGLIETTE

RUBAN  
PROFILÉAPPLIQUE  
PLAFONNIER  
SUSPENSIONEXTÉRIEUR :  
PROJECTEUREXTÉRIEUR :  
HUBLOT  
APPLIQUEEXTÉRIEUR :  
BORNE

POLO LED

IRC >80



230V



850°C

790 lm

Corps aluminium graphite/Diffuseur polycarbonate anti-UV. LED Citizen. Alimentation intégrée IP67.

Version applique

IP 64

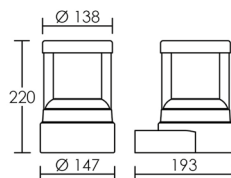

◁150°

50 000 h

| P (w) | Lumens | Teinte   | Code  | € HT   |
|-------|--------|----------|-------|--------|
| 10    | 790    | ○ 4000 K | 50614 | 328,40 |

Version borne haute

IP 65

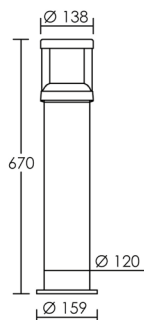

◁150°

50 000 h

| P (w) | Lumens | Teinte   | Code | € HT   |
|-------|--------|----------|------|--------|
| 10    | 790    | ○ 4000 K | 3129 | 502,90 |

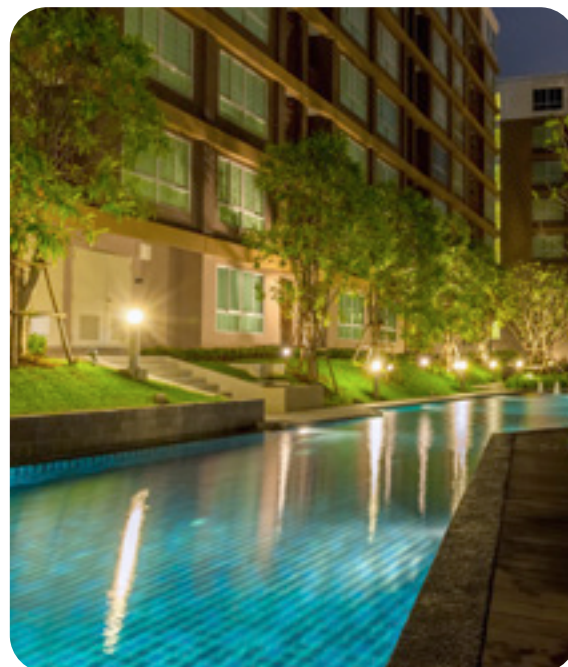

ACCESSOIRE



| Désignation | Code | € HT  |
|-------------|------|-------|
| Fixation    | 0575 | 58,90 |

POLO

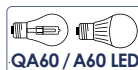

Corps aluminium extrudé/Diffuseur polycarbonate transparent/Paralume inox.

Version applique

IP 44

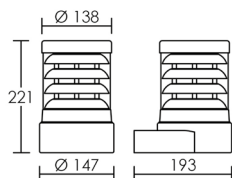

| P (w) | Douille | Couleur   | Code sans lampe | € HT   |
|-------|---------|-----------|-----------------|--------|
| 70    | E27     | graphite  | 3120            | 219,80 |
| 70    | E27     | gris alu. | 3122            | 219,80 |

Version borne basse

IP 65

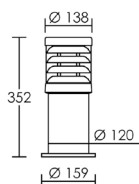

| P (w) | Douille | Couleur       | Code sans lampe | € HT   |
|-------|---------|---------------|-----------------|--------|
| 70    | E27     | graphite      | 3125            | 202,10 |
| 70    | E27     | vert RAL 6005 | 3124            | 213,90 |
| 70    | E27     | gris alu.     | 3123            | 202,10 |

Version borne haute

IP 65

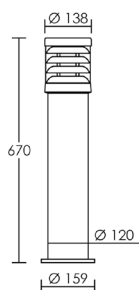

| P (w) | Douille | Couleur       | Code sans lampe | € HT   |
|-------|---------|---------------|-----------------|--------|
| 70    | E27     | graphite      | 3128            | 219,80 |
| 70    | E27     | vert RAL 6005 | 3127            | 232,80 |
| 70    | E27     | gris alu.     | 3126            | 219,80 |



ACCESSOIRES



| Désignation              | Code | € HT   |
|--------------------------|------|--------|
| Platine iodures 35W G8,5 | 0797 | 195,00 |



| Désignation | Code | € HT  |
|-------------|------|-------|
| Fixation    | 0575 | 58,90 |

TURKS



200 lm

Corps aluminium noir/Diffuseur polycarbonate. Traitement anti-corrosion.

Version borne basse

Précâblage H05RN-F - 1,5 m. Fiche 16A IP44.  
Installation : sol, mur, piquet de jardin (inclus).

| 50 000 h |        |        |      |        |
|----------|--------|--------|------|--------|
| P (w)    | Lumens | Teinte | Code | € HT   |
| 3,6      | 200    | 3000 K | 5070 | 184,60 |

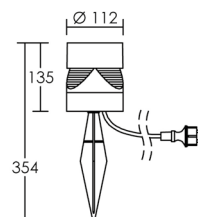

Version borne haute

Précâblage H05RN-F - 1 m.

| 50 000 h |        |        |      |        |
|----------|--------|--------|------|--------|
| P (w)    | Lumens | Teinte | Code | € HT   |
| 3,6      | 200    | 3000 K | 5072 | 223,80 |

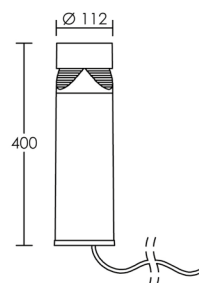

Borne basse

Borne haute

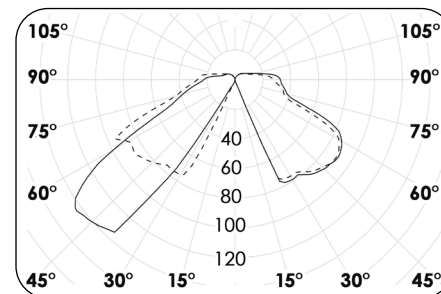

CD/klm  
C0 - C180 --- C90 - C270  $\eta = 100\%$

SAXO



420 lm

Corps aluminium/Diffuseur polycarbonate. Alimentation intégrée.

Version applique

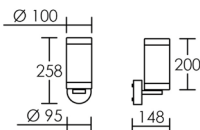

30 000 h

| P (w) | Lumens | Teinte | Code  | € HT   |
|-------|--------|--------|-------|--------|
| 8     | 420    | 3000 K | 50567 | 125,50 |

Dimmable par coupure de phase.

Version borne basse

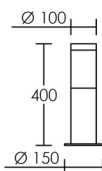

30 000 h

| P (w) | Lumens | Teinte | Code  | € HT   |
|-------|--------|--------|-------|--------|
| 8     | 420    | 3000 K | 50561 | 133,60 |

Dimmable par coupure de phase.

Version borne haute

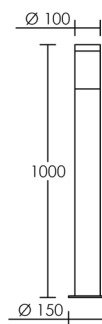

30 000 h

| P (w) | Lumens | Teinte | Code  | € HT   |
|-------|--------|--------|-------|--------|
| 8     | 420    | 3000 K | 50562 | 175,40 |

Dimmable par coupure de phase.

ACCESSOIRE



| Désignation    | Code | € HT  |
|----------------|------|-------|
| Fixation béton | 0127 | 34,70 |

LAMPE

DOWNLIGHT ENCASTRE

RAIL PROJECTEUR SPOTIERIE

RÉGLIETTE

RUBAN PROFILÉ

APPLIQUE PLAFONNIER SUSPENSION

EXTÉRIEUR : PROJECTEUR

EXTÉRIEUR : HUBLOT APPLIQUE

EXTÉRIEUR : BORNE

KADO INOX

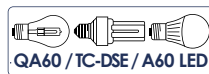

Corps inox 316L/Diffuseur polycarbonate/Tête inox 316L. Lampe E27 diamètre maxi 58 mm, longueur maxi 180 mm.

Version borne basse

| P (w) | Douille | Couleur | Code sans lampe | € HT   |
|-------|---------|---------|-----------------|--------|
| 75    | E27     | inox    | 1675            | 452,30 |

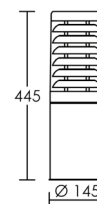

Version borne haute

| P (w) | Douille | Couleur | Code sans lampe | € HT   |
|-------|---------|---------|-----------------|--------|
| 75    | E27     | inox    | 1892            | 633,40 |

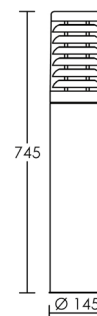

Borne basse



Borne haute



**Kit d'entretien - Code 2166**

✓ Pour conserver les caractéristiques esthétiques de l'INOX une application est préconisée tous les 6 mois

✓ 2 éponges de polissage + 1 agent actif

59,10 € HT

**ACCESSOIRE**

| Désignation | Code | € HT  |
|-------------|------|-------|
| Fixation    | 0448 | 58,90 |



## KADO IMITATION BOIS

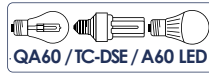

Corps aluminium imitation bois/Diffuseur polycarbonate/  
Tête inox 316L. Lampe E27 diamètre maxi 58 mm,  
longueur maxi 180 mm.

| P (w) | Douille | Couleur             | Code sans lampe | € HT   |
|-------|---------|---------------------|-----------------|--------|
| 75    | E27     | imitation bois/inox | 1893            | 422,20 |

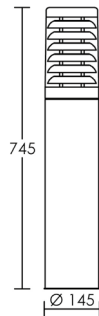

## ACCESSOIRE



| Désignation | Code | € HT  |
|-------------|------|-------|
| Fixation    | 0448 | 58,90 |

LAMPE

DOWNLIGHT  
ENCASTRERAIL  
PROJECTEUR  
SPOTERIE

RÉGLIETTE

RUBAN  
PROFILÉAPPLIQUE  
PLAFONNIER  
SUSPENSIONEXTÉRIEUR :  
PROJECTEUREXTÉRIEUR :  
HUBLOT  
APPLIQUEEXTÉRIEUR :  
BORNE

CALEO 1

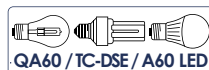

Corps aluminium/Diffuseur polycarbonate/Vis inox.

Version applique



| P (w) | Douille | Couleur  | Code sans lampe | € HT   |
|-------|---------|----------|-----------------|--------|
| 75    | E27     | noir     | 1794            | 202,70 |
| 75    | E27     | blanc    | 1777            | 202,70 |
| 75    | E27     | gris     | 1692            | 200,90 |
| 75    | E27     | graphite | 3133            | 200,90 |

Diffuseur de rechange sur commande, code 0450.

Version borne basse



| P (w) | Douille | Couleur       | Code sans lampe | € HT   |
|-------|---------|---------------|-----------------|--------|
| 100   | E27     | noir          | 1796            | 172,50 |
| 100   | E27     | vert RAL 6005 | 1797            | 182,00 |
| 100   | E27     | blanc         | 1778            | 172,50 |
| 100   | E27     | gris          | 1793            | 174,90 |
| 100   | E27     | graphite      | 3134            | 174,90 |

Diffuseur de rechange sur commande, code 0450.

Version borne haute



| P (w) | Douille | Couleur             | Code sans lampe | € HT   |
|-------|---------|---------------------|-----------------|--------|
| 100   | E27     | noir                | 1798            | 203,20 |
| 100   | E27     | vert RAL 6005       | 1799            | 213,90 |
| 100   | E27     | blanc               | 1779            | 203,20 |
| 100   | E27     | gris                | 1709            | 219,80 |
| 100   | E27     | graphite            | 3135            | 219,80 |
| 100   | E27     | imitation bois/noir | 1837            | 243,50 |
| 100   | E27     | cuivre              | 1706*           | 230,50 |

Diffuseur de rechange sur commande, code 0450.

\*Sur commande. Délai : 5 semaines.

ACCESSOIRE



| Désignation                           | Code | € HT  |
|---------------------------------------|------|-------|
| Fixation CALEO 1 borne haute et basse | 0575 | 58,90 |

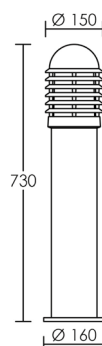

LED p. 20

CALEO 2



Corps inox 316L/Diffuseur polycarbonate. Vis inox.

Version borne basse

| P (w) | Douille | Couleur | Code sans lampe | € HT   |
|-------|---------|---------|-----------------|--------|
| 75    | E27     | inox    | 1691            | 372,90 |

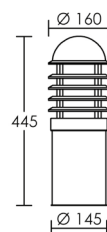

Version borne haute

| P (w) | Douille | Couleur | Code sans lampe | € HT   |
|-------|---------|---------|-----------------|--------|
| 100   | E27     | inox    | 1856            | 610,90 |

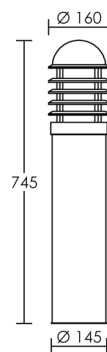

Borne basse

Borne haute

ACCESSOIRES



| Désignation      | Code | € HT  |
|------------------|------|-------|
| Raccord 3 câbles | 0739 | 31,40 |



| Désignation      | Code | € HT  |
|------------------|------|-------|
| Raccord 2 câbles | 0743 | 13,80 |



| Désignation      | Code | € HT  |
|------------------|------|-------|
| Fixation CALEO 2 | 0448 | 58,90 |

LAMPE

DOWNLIGHT ENCASTRE

RAIL PROJECTEUR SPOTIERIE

RÉGLIETTE

RUBAN PROFILÉ

APPLIQUE PLAFONNIER SUSPENSION

EXTÉRIEUR : PROJECTEUR

EXTÉRIEUR : HUBLOT APPLIQUE

EXTÉRIEUR : BORNE

DAO

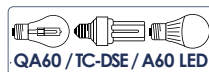

Corps aluminium/Diffuseur polycarbonate.

| P (w) | Douille | Couleur  | Code sans lampe | € HT          |
|-------|---------|----------|-----------------|---------------|
| 11    | E14     | graphite | <b>0340</b>     | <b>171,70</b> |

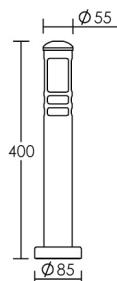

LED p. 22

PAO

500 h BS Uniquement pour version inox

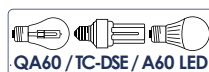

Corps aluminium (**0341**) ou inox 316L (**0370**)/Diffuseur polycarbonate.

| P (w) | Douille | Couleur  | Code sans lampe | € HT          |
|-------|---------|----------|-----------------|---------------|
| 23    | E27     | graphite | <b>0341</b>     | <b>243,50</b> |
| 23    | E27     | inox     | <b>0370</b>     | <b>312,20</b> |

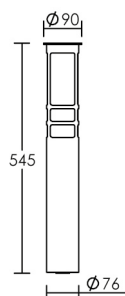

LED p. 20



## NIZA B



Corps aluminium/Verre clair.

| P (w) | Douille | Couleur | Code sans lampe | € HT         |
|-------|---------|---------|-----------------|--------------|
| 60    | E27     | blanc   | <b>1938</b>     | <b>92,90</b> |
| 60    | E27     | noir    | <b>1937</b>     | <b>92,90</b> |

Jeu de verres de rechange, code **1079**.

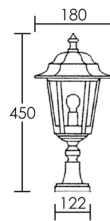

## GREEN



Borne avec prises. Corps thermoplastique vert/gris. Fixation par vis. Fourni avec piquet. 2 m de câble H05RN F 3G1,0 avec fiche 16A.

| Version               | Code        | € HT         |
|-----------------------|-------------|--------------|
| 2 prises 16A (PC + T) | <b>3562</b> | <b>22,40</b> |

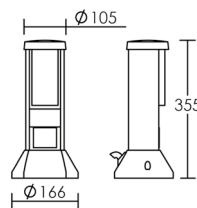

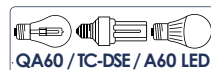

Corps thermoplastique noir/Diffuseur transparent.

### Version applique



| P (w) | Douille | Couleur | Code sans lampe | € HT  |
|-------|---------|---------|-----------------|-------|
| 60    | E27     | noir    | 1894            | 70,40 |

### Version suspension

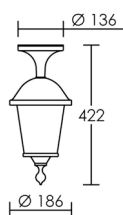

| P (w) | Douille | Couleur | Code sans lampe | € HT  |
|-------|---------|---------|-----------------|-------|
| 60    | E27     | noir    | 1895            | 70,40 |

### Version borne basse

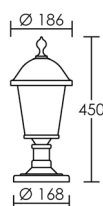

| P (w) | Douille | Couleur | Code sans lampe | € HT  |
|-------|---------|---------|-----------------|-------|
| 60    | E27     | noir    | 1896            | 80,30 |

### Version lanterne sur mât

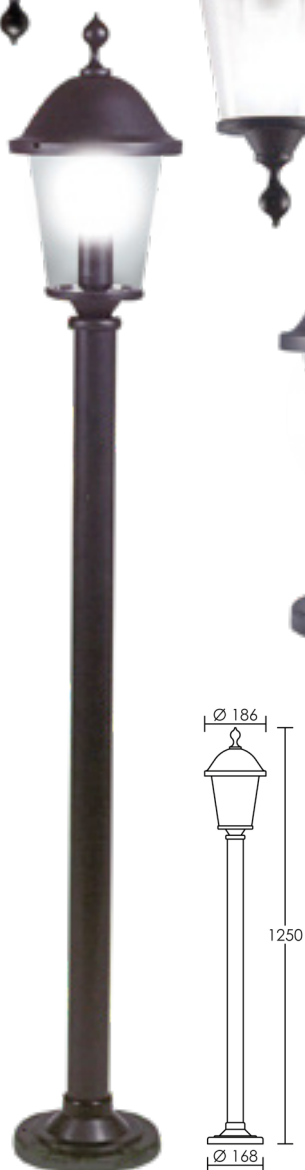

| P (w) | Douille | Couleur | Code sans lampe | € HT   |
|-------|---------|---------|-----------------|--------|
| 60    | E27     | noir    | 1897            | 111,20 |



TOSCANE



Sur commande délai 5 semaines. Corps aluminium/Verre dépoli.

Version applique



| P (w) | Douille | Couleur | Code sans lampe | € HT   |
|-------|---------|---------|-----------------|--------|
| 75    | E27     | noir    | 4070            | 196,70 |
| 75    | E27     | cuivré  | 4080            | 196,70 |

Version mât 1 tête



| P (w) | Douille | Couleur | Code sans lampe | € HT   |
|-------|---------|---------|-----------------|--------|
| 75    | E27     | noir    | 4072            | 696,50 |
| 75    | E27     | cuivré  | 4082            | 696,50 |

Version mât 2 têtes

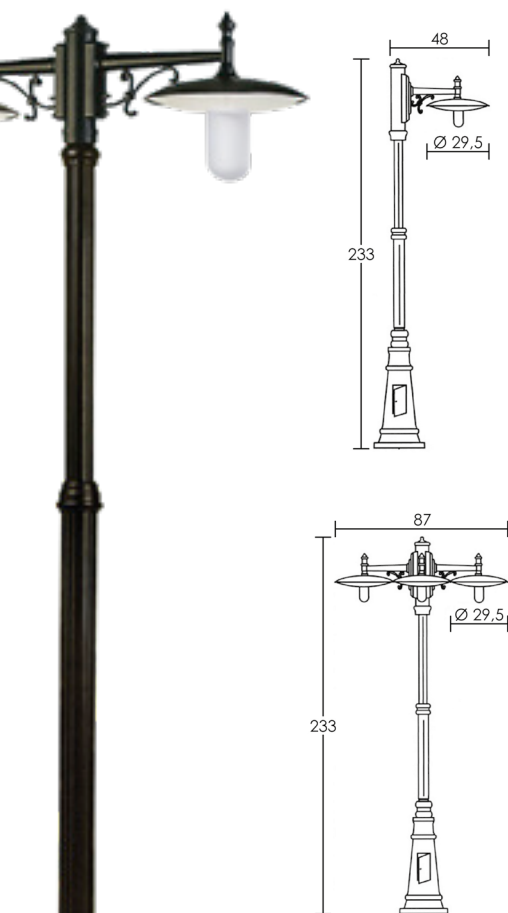

| P (w) | Douille | Couleur | Code sans lampe | € HT   |
|-------|---------|---------|-----------------|--------|
| 75    | E27     | noir    | 4083            | 859,40 |
| 75    | E27     | cuivré  | 4084            | 859,40 |



ACCESSOIRE

| Désignation       | Code | € HT  |
|-------------------|------|-------|
| Verre de rechange | 0359 | 51,40 |

LAMPE  
DOWNLIGHT ENCASTRE  
RAIL PROJECTEUR SPOTIERE  
RÉGLIETTE  
RUBAN PROFILÉ  
APPLIQUE PLAFONNIER SUSPENSION  
EXTÉRIEUR : PROJECTEUR  
EXTÉRIEUR : HUBLOT APPLIQUE  
EXTÉRIEUR : BORNE

MONACO

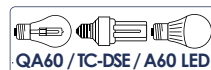

Sur commande délai 5 semaines. Corps aluminium. 100W, douille E27.



Version 01 - Applique basse

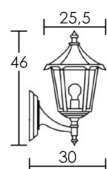

| Couleur      | Code sans lampe | € HT   |
|--------------|-----------------|--------|
| blanc        | 3030            | 101,30 |
| vert antique | 3031            | 101,30 |
| tout noir    | 3032            | 101,30 |
| cuivre/noir  | 3033            | 135,20 |

Version 01 - Applique haute

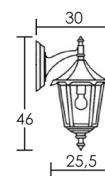

| Couleur      | Code sans lampe | € HT   |
|--------------|-----------------|--------|
| blanc        | 3034            | 101,30 |
| vert antique | 3035            | 101,30 |
| tout noir    | 3036            | 101,30 |
| cuivre/noir  | 3037            | 135,20 |

Version 02 - Suspension



| Couleur      | Code sans lampe | € HT   |
|--------------|-----------------|--------|
| blanc        | 3038            | 101,30 |
| vert antique | 3039            | 101,30 |
| tout noir    | 3040            | 101,30 |
| cuivre/noir  | 3041            | 143,60 |

Version 33 - Borne basse



| Couleur      | Code sans lampe | € HT   |
|--------------|-----------------|--------|
| blanc        | 3042            | 116,80 |
| vert antique | 3043            | 116,80 |
| tout noir    | 3044            | 116,80 |
| cuivre/noir  | 3045            | 149,20 |

Version 44 - Lanterne sur mât

Hauteur : 1,16 m.



| Couleur      | Code sans lampe | € HT   |
|--------------|-----------------|--------|
| blanc        | 3046            | 135,20 |
| vert antique | 3047            | 135,20 |
| tout noir    | 3048            | 135,20 |
| cuivre/noir  | 3049            | 171,70 |

Version PF4 - Lanterne sur mât

Hauteur : 1,55 m.



| Couleur      | Code sans lampe | € HT   |
|--------------|-----------------|--------|
| blanc        | 3058            | 284,30 |
| vert antique | 3059            | 284,30 |
| tout noir    | 3060            | 284,30 |
| cuivre/noir  | 3061            | 322,30 |

ACCESSOIRES

| Désignation       | Couleur | Code | € HT  |
|-------------------|---------|------|-------|
| fixation d'angle  | noir    | 1985 | 21,20 |
| H 100 x L 70      | blanc   | 1986 | 21,20 |
| verre de rechange | -       | 1127 | 11,60 |



| Désignation                          | Code | € HT  |
|--------------------------------------|------|-------|
| fixation APF6 sol pour PF4 seulement | 2124 | 64,80 |



## MONACO



Sur commande délai 5 semaines. Corps aluminium. 100W, douille E27.

## Version PE7 - 1 lanterne sur mât

Hauteur : 1,91 m

| Couleur      | Code sans lampe | € HT   |
|--------------|-----------------|--------|
| blanc        | 3062            | 480,00 |
| vert antique | 3063            | 480,00 |
| tout noir    | 3064            | 480,00 |
| cuivre/noir  | 3065            | 515,20 |

## Version PE8 - 1 lanterne sur mât

Hauteur : 2,49 m

| Couleur      | Code sans lampe | € HT   |
|--------------|-----------------|--------|
| blanc        | 3066            | 518,00 |
| vert antique | 3067            | 518,00 |
| tout noir    | 3068            | 518,00 |
| cuivre/noir  | 3069            | 546,10 |

## Version PE8T2 - 2 lanternes sur mât

Hauteur : 2,55 m

| Couleur      | Code sans lampe | € HT   |
|--------------|-----------------|--------|
| blanc        | 3070            | 647,50 |
| vert antique | 3071            | 647,50 |
| tout noir    | 3072            | 647,50 |
| cuivre/noir  | 3073            | 723,50 |

## Version PE8T3 - 3 lanternes sur mât

Hauteur : 2,55 m

| Couleur      | Code sans lampe | € HT   |
|--------------|-----------------|--------|
| blanc        | 3074            | 746,00 |
| vert antique | 3075            | 746,00 |
| tout noir    | 3076            | 746,00 |
| cuivre/noir  | 3077            | 845,90 |

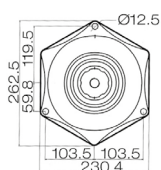
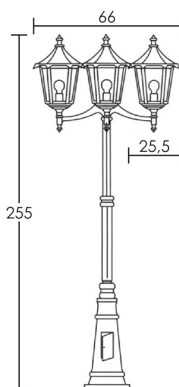
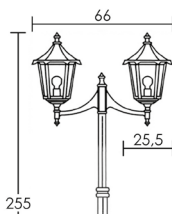
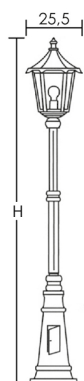

LED p. 20

## ACCESSOIRES

Jeu de 6 verres de rechange.

| Désignation | Code | € HT  |
|-------------|------|-------|
| PE8T2-PE8T3 | 1127 | 11,60 |
| PE7 et PE8  | 1173 | 2,50  |



Pour PE7 et PE8.

| Désignation   | Code | € HT  |
|---------------|------|-------|
| pour APF8 sol | 2125 | 64,80 |

LENA

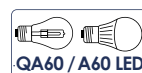

Applique Ø200 mm. Support thermoplastique/Globe PMMA.

Version applique

IP  
43

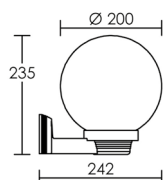

| P (w) | Douille | Couleur     | Code sans lampe | € HT  |
|-------|---------|-------------|-----------------|-------|
| 60    | E27     | noir fumé   | 1707            | 31,10 |
| 60    | E27     | blanc opale | 1719            | 31,10 |

Version borne basse

IP  
41

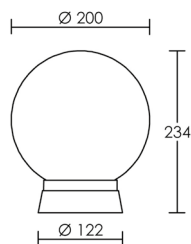

| P (w) | Douille | Couleur     | Code sans lampe | € HT  |
|-------|---------|-------------|-----------------|-------|
| 40    | E27     | noir fumé   | 1722            | 29,90 |
| 40    | E27     | blanc opale | 1723            | 29,90 |

GLOBES DE RECHANGE

| Référence | Ø base intérieure | Ø base extérieure | Ø globe | Couleur | Code | € HT  |
|-----------|-------------------|-------------------|---------|---------|------|-------|
| LENA      | 84 mm             | 100 mm            | 200 mm  | opale   | 0818 | 15,40 |
| LENA      | 84 mm             | 100 mm            | 200 mm  | fumé    | 0812 | 15,40 |
| LUNA      | 100 mm            | 120 mm            | 250 mm  | opale   | 0923 | 26,00 |
| LUNA      | 100 mm            | 120 mm            | 250 mm  | fumé    | 0922 | 26,00 |

LUNA



Applique Ø250 mm. Globe PMMA.

Version applique

Support thermoplastique.



| P (w) | Douille | Couleur     | Code sans lampe | € HT  |
|-------|---------|-------------|-----------------|-------|
| 100   | E27     | noir fumé   | 1708            | 44,40 |
| 100   | E27     | blanc opale | 1704            | 44,40 |

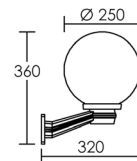

base 100 x 100  
entraxe 83 mm

Version borne basse

Support thermoplastique.



| P (w) | Douille | Couleur     | Code sans lampe | € HT  |
|-------|---------|-------------|-----------------|-------|
| 100   | E27     | noir fumé   | 1716            | 40,20 |
| 100   | E27     | blanc opale | 1717            | 40,20 |

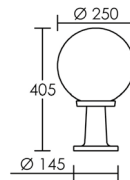

Version borne haute

Mât thermoplastique noir.



| P (w) | Douille | Couleur     | Code sans lampe | € HT  |
|-------|---------|-------------|-----------------|-------|
| 100   | E27     | noir fumé   | 1710            | 74,30 |
| 100   | E27     | blanc opale | 1718            | 81,60 |

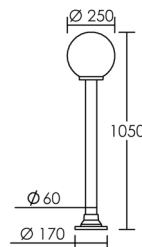

LAMPE

DOWNLIGHT  
ENCASTRE

RAIL  
PROJECTEUR  
SPOTIERE

RÉGLIETTE

RUBAN  
PROFILÉ

APPLIQUE  
PLAFONNIER  
SUSPENSION

EXTÉRIEUR :  
PROJECTEUR

EXTÉRIEUR :  
HUBLOT  
APPLIQUE

EXTÉRIEUR :  
BORNE

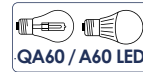

Support thermoplastique/Globe opale.

Version applique



| P (w) | Douille | Couleur | Code sans lampe | € HT  |
|-------|---------|---------|-----------------|-------|
| 60    | E27     | noir    | 1945            | 66,20 |

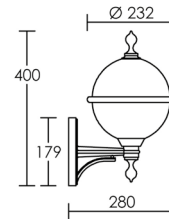

Version borne basse

| P (w) | Douille | Couleur | Code sans lampe | € HT  |
|-------|---------|---------|-----------------|-------|
| 60    | E27     | noir    | 1946            | 77,40 |

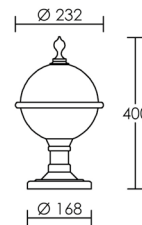

Version borne haute

| P (w) | Douille | Couleur | Code sans lampe | € HT   |
|-------|---------|---------|-----------------|--------|
| 60    | E27     | noir    | 1947            | 105,60 |

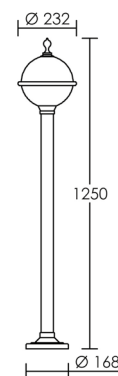

BALI

Eclairage à composer pour mât Ø60 mm.

Globe

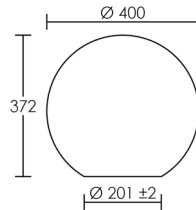

Globe en PMMA.

| Globe       | Code        | € HT          |
|-------------|-------------|---------------|
| transparent | <b>0804</b> | <b>93,30</b>  |
| blanc opale | <b>0827</b> | <b>96,90</b>  |
| 1/2 opaque  | <b>0803</b> | <b>185,50</b> |

Ballast

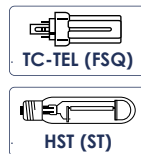
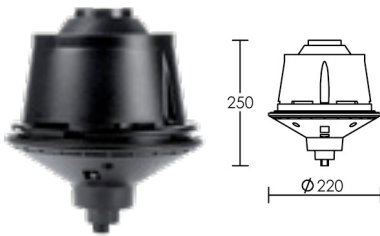

Base thermoplastique. Avec appareillage pour poteau Ø60 mm.

| Version | P (W) | Douille | Code sans lampe | € HT          |
|---------|-------|---------|-----------------|---------------|
| fluo    | 42    | GX24q-4 | <b>0435*</b>    | <b>212,70</b> |
| sodium  | 70    | E27     | <b>0433</b>     | <b>179,60</b> |

\*Ballast électronique A2.

Diffuseur



Réflecteur



Diffuseur

| Accessoires | Code        | € HT          |
|-------------|-------------|---------------|
| Réflecteur  | <b>1858</b> | <b>172,50</b> |
| Diffuseur   | <b>1859</b> | <b>95,70</b>  |

Mâts standards Ø60 - p. 416



| H (m) | Code        | € HT          |
|-------|-------------|---------------|
| 0,50  | <b>2059</b> | <b>170,30</b> |
| 1     | <b>2060</b> | <b>188,60</b> |
| 1,50  | <b>2061</b> | <b>222,40</b> |
| 2     | <b>2063</b> | <b>236,40</b> |



| H (m) | Code        | € HT          |
|-------|-------------|---------------|
| 2,50  | <b>3130</b> | <b>430,70</b> |
| 3     | <b>3131</b> | <b>454,60</b> |

Exemple de commande

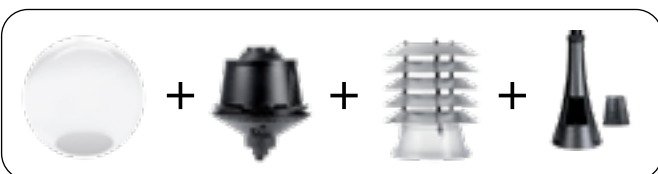

BRASBOUL

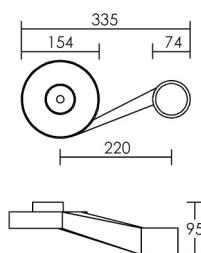

Support thermoplastique pour globe de 300 mm, p. 415.  
Compatible avec les mâts standards de Ø60 mm, p. 416.

| Ø globe | Ø mât | Couleur | Code        | € HT         |
|---------|-------|---------|-------------|--------------|
| 300 mm  | 60 mm | noir    | <b>2149</b> | <b>31,10</b> |

Exemple de composition



| Désignation           | Code        | € HT          |
|-----------------------|-------------|---------------|
| 1 mât de 2 m          | <b>2063</b> | <b>236,40</b> |
| 2 Brasboul            | <b>2149</b> | <b>31,10</b>  |
| 2 globes opales (300) | <b>2051</b> | <b>33,80</b>  |
| 1 bouchon             | <b>2018</b> | <b>2,00</b>   |



| Désignation           | Code        | € HT          |
|-----------------------|-------------|---------------|
| 1 mât de 2 m          | <b>2063</b> | <b>236,40</b> |
| 2 Brasboul            | <b>2149</b> | <b>31,10</b>  |
| 3 globes opales (300) | <b>2051</b> | <b>33,80</b>  |



ROSA



Base thermoplastique. Globe PMMA. Avec fixation 1/4 de tour.



E27

| P (W) | Ø (mm) | Couleur     | Code sans lampe | € HT   |
|-------|--------|-------------|-----------------|--------|
| 150   | 300    | blanc opale | 2051            | 33,80  |
| 150   | 300    | noir fumé   | 2052            | 33,80  |
| 150   | 300    | 1/2 argenté | 2053            | 66,20  |
| 150   | 400    | blanc opale | 2055            | 71,80  |
| 150   | 400    | noir fumé   | 2056            | 71,80  |
| 150   | 400    | 1/2 argenté | 2057            | 128,10 |

Pas de possibilité d'appareillage.

Mâts standards Ø60 - p. 416



| H (m) | Code | € HT   |
|-------|------|--------|
| 0,50  | 2059 | 170,30 |
| 1     | 2060 | 188,60 |
| 1,50  | 2061 | 222,40 |
| 2     | 2063 | 236,40 |



| H (m) | Code | € HT   |
|-------|------|--------|
| 2,50  | 3130 | 430,70 |
| 3     | 3131 | 454,60 |

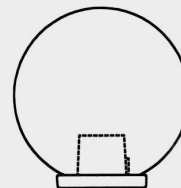

Composez votre luminaire choix du globe, choix du mât.

**Exemple de commande :**  
1 mât de 2 m avec 1 globe Ø300 mm opale blanc, code 2063 et 2051

LAMPE

DOWNLIGHT ENCASTRE

RAIL PROJECTEUR SPOTERIE

RÉGLIETTE

RUBAN PROFILÉ

APPLIQUE PLAFONNIER SUSPENSION

EXTÉRIEUR : PROJECTEUR

EXTÉRIEUR : HUBLOT APPLIQUE

EXTÉRIEUR : BORNE

MATEO

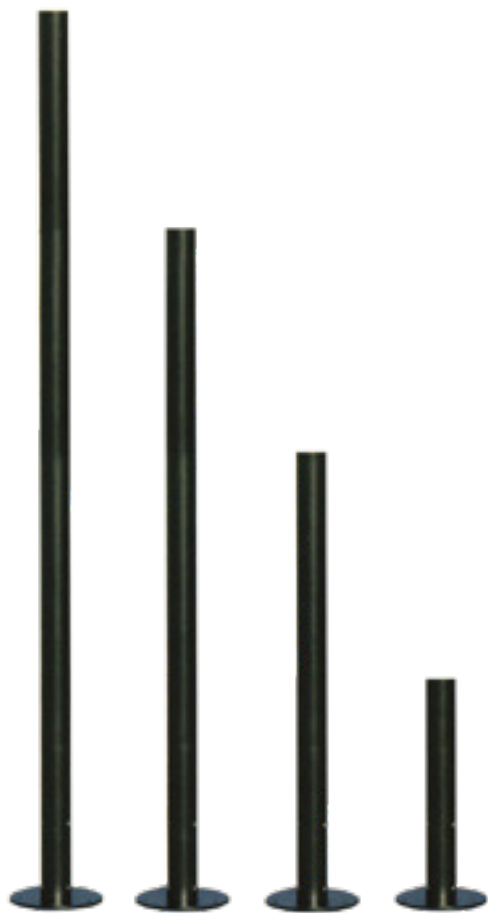

Mâts alu. standards noirs Ø60 mm.

| H (m) | Code        | € HT          |
|-------|-------------|---------------|
| 0,50  | <b>2059</b> | <b>170,30</b> |
| 1     | <b>2060</b> | <b>188,60</b> |
| 1,50  | <b>2061</b> | <b>222,40</b> |
| 2     | <b>2063</b> | <b>236,40</b> |

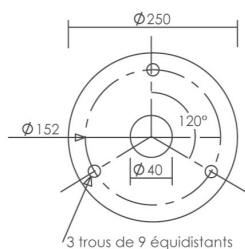

Mâts alu. standards noirs 9005 mat, Ø60 mm. Porte de visite. Fixation béton incluse.

| H (m) | Code        | € HT          |
|-------|-------------|---------------|
| 2,50  | <b>3130</b> | <b>430,70</b> |
| 3     | <b>3131</b> | <b>454,60</b> |

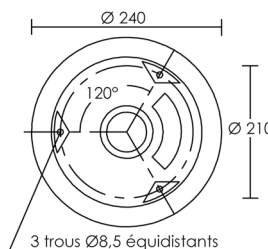

Fixation béton

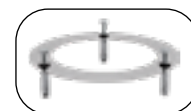

ACCESSOIRES

| Désignation            | Code        | € HT         |
|------------------------|-------------|--------------|
| Fixation dans la terre | <b>0952</b> | <b>55,70</b> |



| Désignation        | Code        | € HT         |
|--------------------|-------------|--------------|
| Fixation sol béton | <b>2127</b> | <b>59,10</b> |



MORPHIS



1700 lm



Tête de lanterne aluminium extrudé graphite/  
Diffuseur polycarbonate transparent. **LED CITIZEN.**  
**Alimentation intégrée.**

50 000 h

| P (w) | Lumens | Teinte | Code  | € HT   |
|-------|--------|--------|-------|--------|
| 33    | 1700   | 3000 K | 50295 | 592,60 |

Mât à commander séparément.

Exemple de commande :  
lanterne avec mât de 3 m.

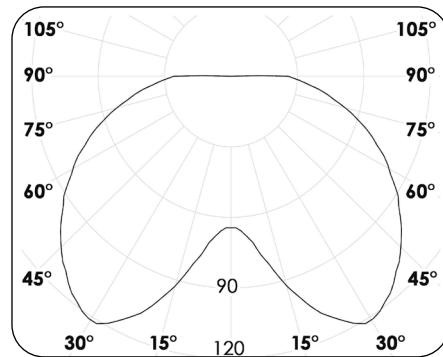
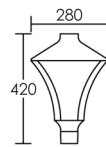

CD/klm  
C0 - C180 --- C90 - C270 η = 100%



Mâts standards Ø60 - p. 416



| H (m) | Code | € HT   |
|-------|------|--------|
| 2,50  | 3130 | 430,70 |
| 3     | 3131 | 454,60 |

LAMPE

DOWNLIGHT  
ENCASTRE

RAIL  
PROJECTEUR  
SPOTIERE

RÉGLIETTE

RUBAN  
PROFILÉ

APPLIQUE  
PLAFONNIER  
SUSPENSION

EXTÉRIEUR :  
PROJECTEUR

EXTÉRIEUR :  
HUBLOT  
APPLIQUE

EXTÉRIEUR :  
BORNE



# SOMMAIRE | ACCESSOIRES

## PROTECTION ENCASTRÉ

SPOTISOL .....p. 420



ÉCARTEUR ISOLANT  
LED .....p. 421



## ACCESSOIRE DÉTECTION

DE 473 .....p. 422



HP 610 .....p. 423



INTER SENITIF .....p. 424



SENSOR 1 .....p. 425



## ALIMENTATION VARIATION

PLATINE  
IODURE .....p. 426



ALIM. LED 12V .....p. 427



ALIM. 24V  
intérieur .....p. 428



ALIM. 24V  
extérieur .....p. 429



ALIM. LED CC .....p. 430



GESTION  
VARIATION .....p. 432



CONVERTISSEUR .....p. 435



TRANSFORMATEUR .....p. 435



TRANSFO  
pour rail .....p. 437



## RAIL D'ALIMENTATION

RAIL 1 ALLUM  
230V .....p. 438



RAIL 3 ALLUM  
230V .....p. 441



## CONNEXION ÉTANCHE

RL 2 / RL 3 .....p. 442



## BOÎTE D'ENCASTREMENT POUR PLAFOND DUR

B1 .....p. 443



B2 .....p. 443



B20 .....p. 443



B30 .....p. 443



PIÈCES DÉTACHÉES .....p. 444

GLOSSAIRES DES PICTOGRAMMES ET SYMBOLES NORMATIFS .....p. 448

INSTALLATION ET ENTRETIEN DES ENCASTRÉS DE SOL, BORNES ET LAMPADAIRES .....p. 450

CLASSIFICATION DES VOLUMES .....p. 452

DÉCOUPES .....p. 485

## SPOTISOL

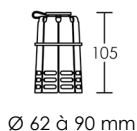

Accessoire de pose pour encastré de plafond.

SPOTISOL permet de **séparer les spots des isolants rouleau** tout en maintenant le boîtier de connexion du spot.

- Diamètres compris entre 62 et 90 mm ;
- Hauteur : 105 mm ;
- Utilisable de -20°C à +110°C en continu ;
- Puissance maximum : 50W avec isolation en rouleau ;
- Résistance au feu : auto-extinguible UL94 V2.

| Code | € HT |
|------|------|
| 3670 | 6,00 |



## Séparateur d'isolant rouleau

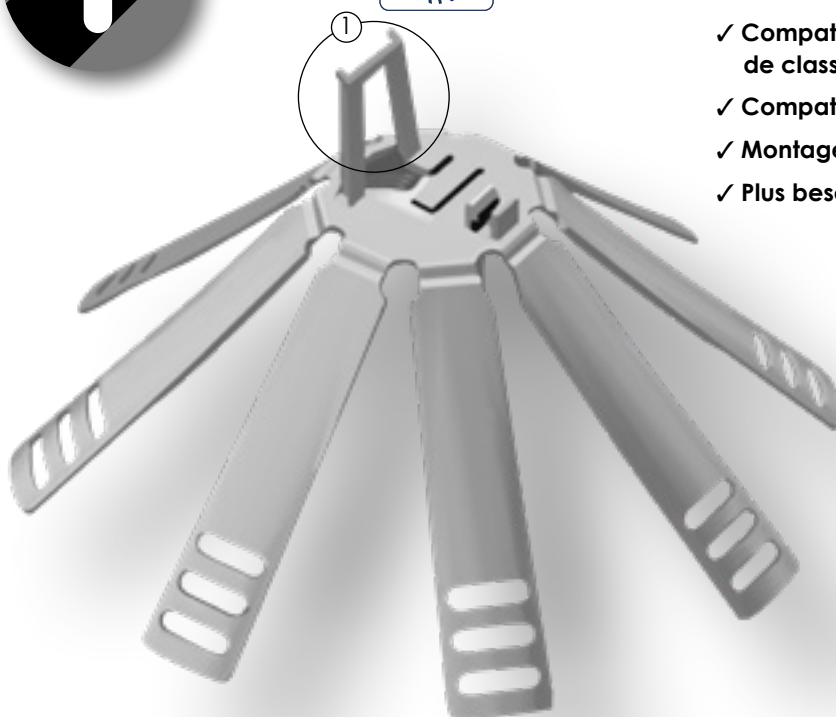

- ✓ Compatibilité tous types d'isolant rouleau de classe MO incombustible
- ✓ Compatible avec les spots halogènes et LED
- ✓ Montage sans outil
- ✓ Plus besoin d'accéder aux combles

- ① Fixation possible du boîtier de connexion sur le haut du pot
- ② Sa conception permet son maintien dans les faux plafonds : impossible de le perdre

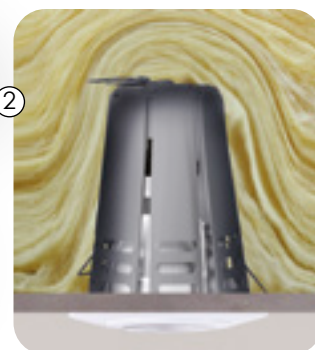

## ÉCARTEUR ISOLANT LED

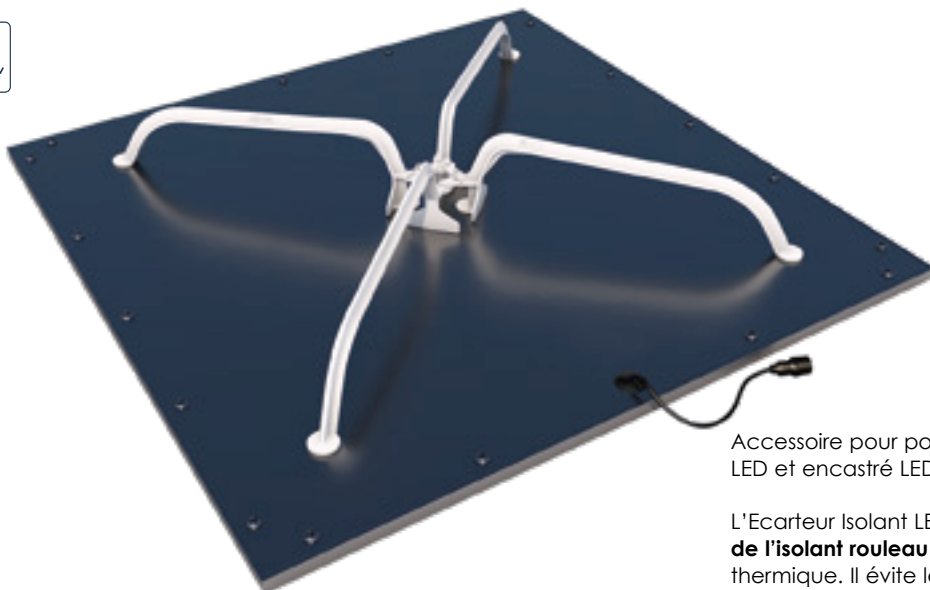

Vidéo  
de présentation

Accessoire pour pose d'isolant thermique sur dalle LED et encastré LED, type FLAT, LEDIUM...

L'Ecarteur Isolant LED permet de **séparer les encastrés de l'isolant rouleau** en créant un espace d'aération thermique. Il évite les risques de surchauffe des appareils (LED et alimentations).

- Diamètre minimum 120 mm ;
- Hauteur : 80 mm ;
- Utilisable de -20°C à +45°C ;
- Résistance au feu : auto-extinguible UL94 V2.

| Code | € HT  |
|------|-------|
| 3671 | 12,20 |

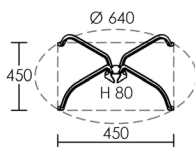
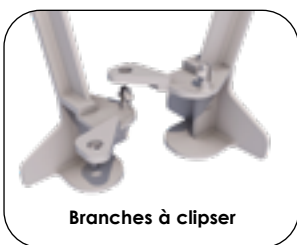

## Séparateur d'isolant rouleau

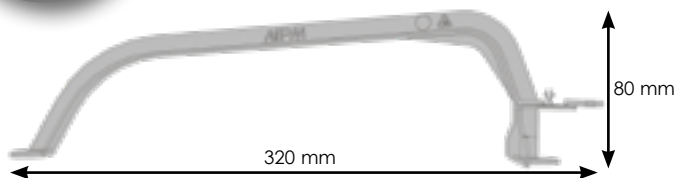

- ✓ Compatibilité tous types d'isolant rouleau de classe MO incombustible
- ✓ Montage sans outil : branches clipsables + 4 pastilles adhésives fournies
- ✓ Plus besoin d'accéder aux combles : passage de l'écarteur dans un diamètre de découpe mini. de 120 mm

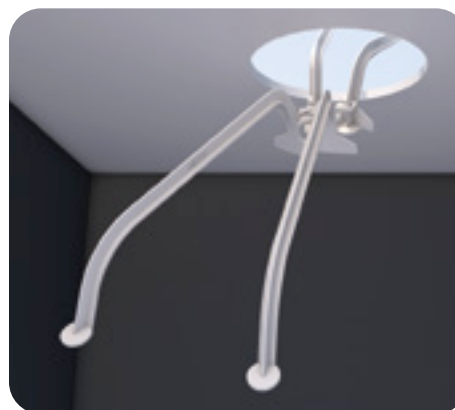
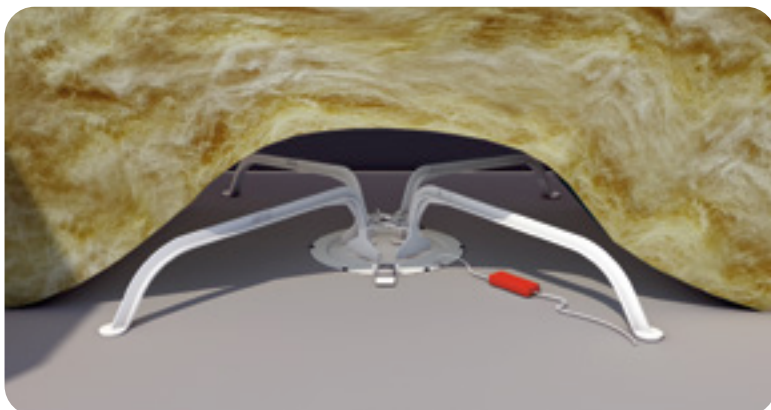



# Fonctionnement de la détection

## ✓ Principe

Le détecteur seul ou intégré au luminaire surveille continuellement une zone prédéfinie et allume immédiatement la lampe dès qu'un mouvement est détecté.



## ✓ Détecteurs

Il existe deux types de détecteur :

- ▶ **Le détecteur IR passif à infrarouge** (tête de détection apparente et visible) détection limitée, ne traverse pas les parois et les murs ;
- ▶ **Le détecteur HP hyper fréquence** ou haute fréquence 5,8 GHz (détecteur invisible placé à l'intérieur du luminaire). Détection des mouvements à travers les portes, vitres et les parois de faible épaisseur.

Si le capteur détecte un autre mouvement, la durée d'allumage recommence son cycle.

## ✓ Caractéristiques techniques

- ▶ Angle ouverture du faisceau de la détection : 160° à 180°/360° (suivant les modèles)
- ▶ Tension : 230/240V - 50/60 Hz - CI 2 - IP20.

## ✓ Réglages



- 1) Un bouton « **LUX** » pour régler le seuil lumineux d'activation de la détection.  
Déclenchement de la cellule crépusculaire : de 2 lux à 2000 lux. (suivant les modèles)

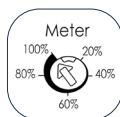

- 2) Un bouton « **METER** » pour ajuster la distance de la détection : de 1 à 8 m. (suivant les modèles)



- 3) Un bouton « **TIME** » afin de régler la durée pendant laquelle la lumière doit rester allumée. Temps d'allumage suite à une détection : de 5 sec. à 30 min. (suivant les modèles)

## DE 473



Livré avec lentilles d'occultation.

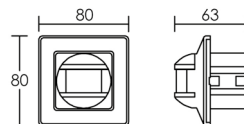

Détecteur IR infrarouge ou interrupteur automatique à encastrer dans une boîte standard Ø65 mm. Utilisation intérieure.

| Référence | Code | € HT  |
|-----------|------|-------|
| DE 473    | 2182 | 20,40 |

### Raccordement direct du luminaire

#### ⚡ Puissance maximum

Incandescent 1600 W  
Halogène 1000 W  
Fluorescent 300 W

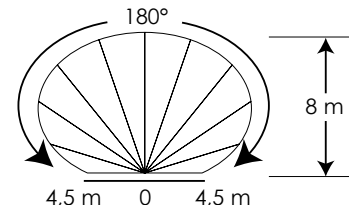
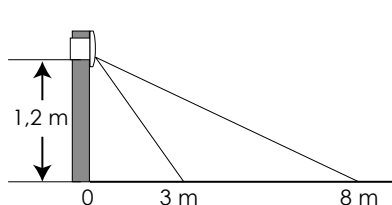
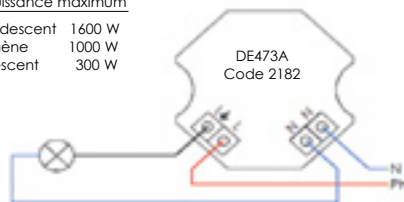

# HP 610

Détecteur HF hyper fréquence à intégrer dans les luminaires : hublots, appliques... Utilisation intérieure.



| Référence | Code | € HT  |
|-----------|------|-------|
| HP 610    | 2167 | 59,10 |

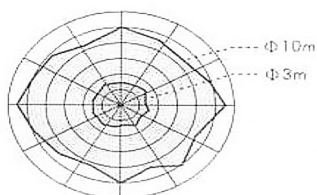
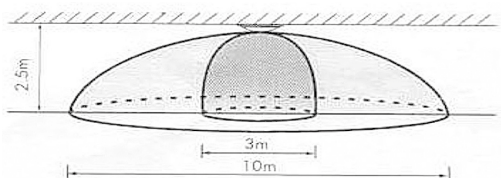
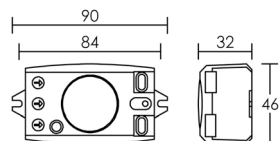

## Schéma raccordement Détecteur Hyperfréquence

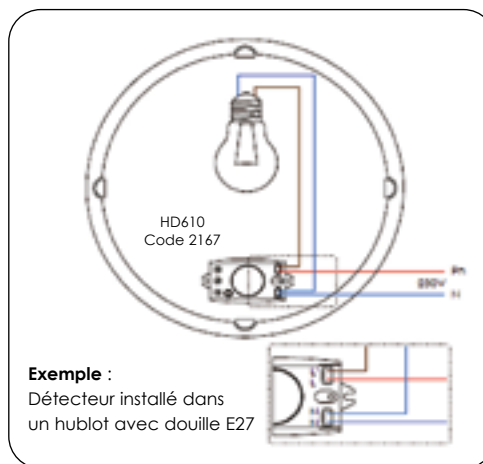
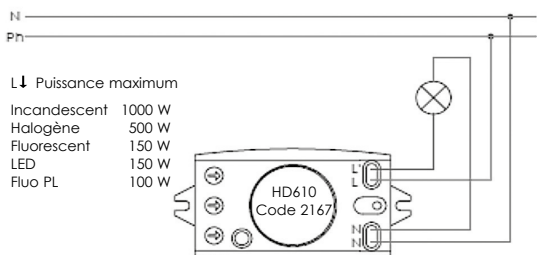

## Schéma de raccordement : Maître et esclave

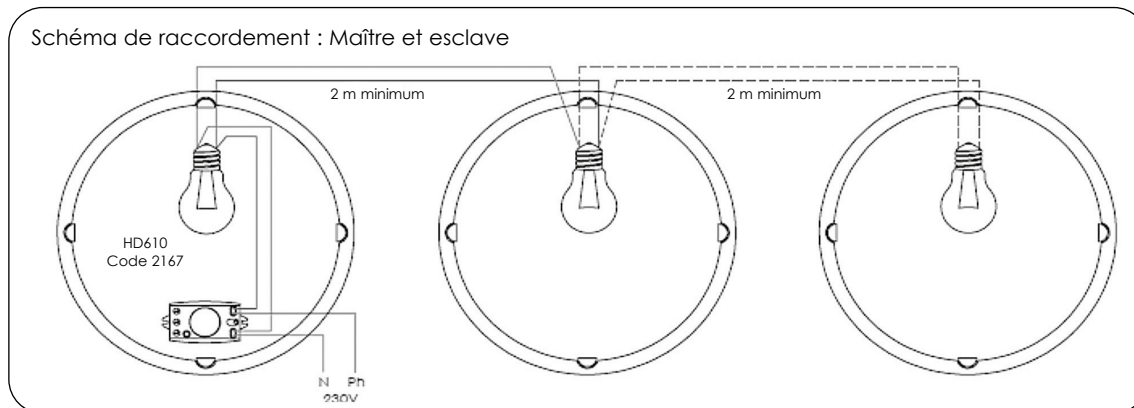



## INTER SENSITIF



### Interrupteur miniature sensible

Alimentation 230V.

| Référence | Code | € HT  |
|-----------|------|-------|
| HZK-218 C | 1956 | 37,80 |

Boîtier de commande :  
L x l x h : 83 x 35 x 19 mm.

Interrupteur miniature sensible à installer dans des parois d'épaisseur minimum de 19 mm. Fonctionne au passage de la main. Interrupteur de sécurité. Capteur déporté, Câble 1,5 m et connexion sans outil. Préconisé pour les volumes 1 et 2 des salles d'eau.



## SENSOR PORTE



### Détecteur d'ouverture de porte

Alimentation 230V.

| Référence | Code | € HT  |
|-----------|------|-------|
| HZK-218 B | 1955 | 37,80 |

Boîtier de commande :  
L x l x h : 83 x 35 x 19 mm.

Interrupteur contact de porte à installer dans des parois d'épaisseur minimum de 19 mm. Fonctionne en ouverture ou fermeture de porte. Capteur déporté. Câble 1,5 m et connexion sans outil.

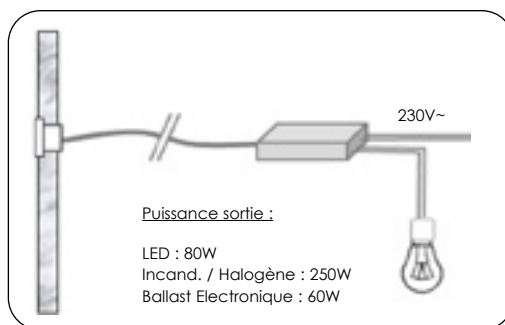





## SENSOR 1



### Détecteur de présence

Alimentation 230V.

| Référence | Code | € HT  |
|-----------|------|-------|
| SHE-B-250 | 1954 | 41,40 |

Boîtier de commande :  
L x l x h : 83 x 35 x 19 mm.

Micro-détecteur de passage infrarouge à tête déportée, à installer dans les plafonds et les cloisons. Installation horizontale ou verticale. Capteur déporté. Câble 1,5 m et connexion sans outil.

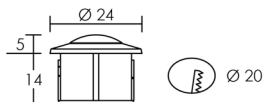

### Réglages

Temporisation de 10 sec. à 3 min.  
Utilisation intérieure.

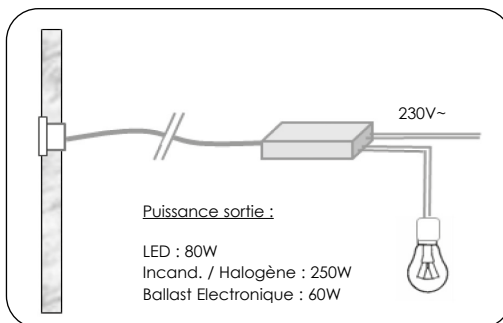
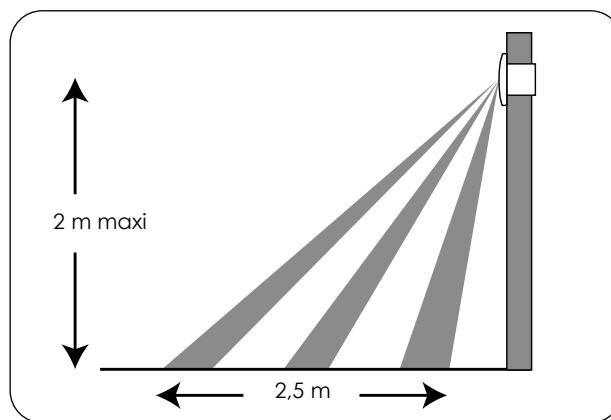
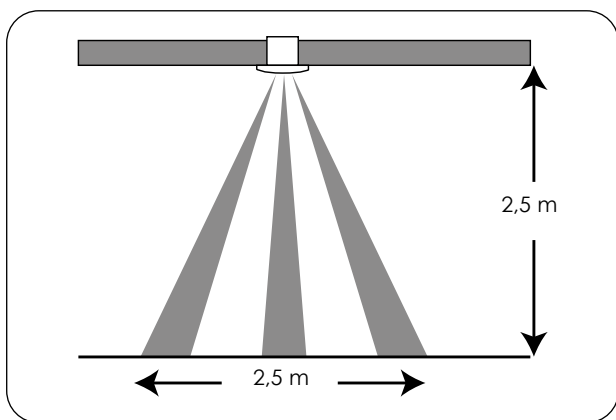

# PLATINE EVT



230V

IP 20

850°C



Platine décharge électronique pour lampe iodures métalliques.

| Version | P (w) | L (mm) | Code        | € HT          |
|---------|-------|--------|-------------|---------------|
| Iodures | 35    | 171    | <b>0680</b> | <b>68,40</b>  |
| Iodures | 70    | 171    | <b>0690</b> | <b>68,40</b>  |
| Iodures | 150   | 217    | <b>0700</b> | <b>135,00</b> |

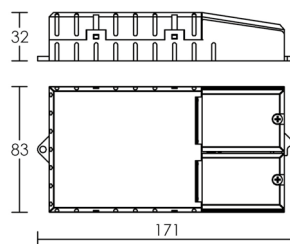

# ALIMENTATION LED intérieure / extérieure 12V

## Transformateurs ferromagnétiques 12V 50 Hz



| P (w) | IP    | Code        | € HT         |
|-------|-------|-------------|--------------|
| 50    | 44/66 | <b>0888</b> | <b>64,90</b> |

Câble de 2,70 m au primaire.  
Câble de 2 m + fiche 2P 6A au secondaire.

## Alimentations extra-plates



| P (w) | IP | Code         | € HT         |
|-------|----|--------------|--------------|
| 20    | 20 | <b>52004</b> | <b>38,20</b> |

L x l x h = 166 x 40 x 14 mm

## Alimentations



| P (w) | IP | Code        | € HT         |
|-------|----|-------------|--------------|
| 12    | 20 | <b>0693</b> | <b>26,20</b> |

L x l x h = 85 x 40 x 22 mm



| P (w) | IP | Code         | € HT         |
|-------|----|--------------|--------------|
| 12    | 20 | <b>52029</b> | <b>18,00</b> |

L x l x h = 100 x 42 x 25 mm  
Câble de 1 m au primaire.  
Câble de 1 m au secondaire.



| P (w) | IP | Code        | € HT         |
|-------|----|-------------|--------------|
| 30    | 20 | <b>0636</b> | <b>37,70</b> |

L x l x h = 165 x 40 x 30 mm



| P (w) | IP | Code        | € HT         |
|-------|----|-------------|--------------|
| 60    | 20 | <b>0744</b> | <b>75,50</b> |

L x l x h = 250 x 40 x 21 mm

## Alimentations extérieures



| P (w) | IP | Code        | € HT         |
|-------|----|-------------|--------------|
| 15    | 67 | <b>0650</b> | <b>50,00</b> |

L x l x h = 130 x 40 x 21 mm  
Câble de 1 m au primaire.  
Câble de 0,5 m au secondaire.

## Appareils 12V AC/DC



SUB 50

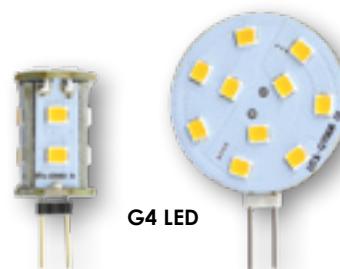

G4 LED



GU5,3 LED 6W



ENZO B4



HIDRO



ZETA

LAMPE

DOWNLIGHT  
ENCASTRE

RAIL  
PROJECTEUR  
SPOTIERE

RÉGLLETTE

RUBAN  
PROFILÉ

APPLIQUE  
PLAFONNIER  
SUSPENSION

EXTÉRIEUR :  
PROJECTEUR

EXTÉRIEUR :  
HUBLOT  
APPLIQUE

EXTÉRIEUR :  
ENCASTRE  
BORNE

ACCESSOIRES

# ALIMENTATION LED intérieure 24V DC

## Alimentations extra-plates



| P (w) | IP | Code         | € HT         |
|-------|----|--------------|--------------|
| 7,2   | 20 | <b>52003</b> | <b>22,30</b> |

L x l x h = 118 x 40 x 10 mm



| P (w) | IP | Code         | € HT         |
|-------|----|--------------|--------------|
| 15    | 20 | <b>52007</b> | <b>26,50</b> |

L x l x h = 121 x 45 x 16 mm

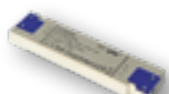

| P (w) | IP | Code         | € HT         |
|-------|----|--------------|--------------|
| 20    | 20 | <b>52005</b> | <b>38,20</b> |

L x l x h = 166 x 40 x 14 mm

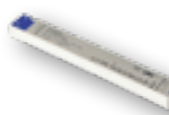

| P (w) | IP | Code         | € HT         |
|-------|----|--------------|--------------|
| 30    | 20 | <b>52012</b> | <b>52,00</b> |

L x l x h = 246 x 30 x 16 mm

## Alimentations



| P (w) | IP | Code        | € HT         |
|-------|----|-------------|--------------|
| 12    | 20 | <b>0697</b> | <b>25,10</b> |

L x l x h = 84 x 40 x 22 mm



| P (w) | IP | Code        | € HT         |
|-------|----|-------------|--------------|
| 30    | 20 | <b>0632</b> | <b>37,70</b> |

L x l x h = 165 x 40 x 30 mm



| P (w) | IP | Code        | € HT         |
|-------|----|-------------|--------------|
| 60    | 20 | <b>0675</b> | <b>70,40</b> |

L x l x h = 188 x 45 x 30 mm



| P (w) | IP | Code         | € HT         |
|-------|----|--------------|--------------|
| 75    | 20 | <b>52010</b> | <b>79,60</b> |

L x l x h = 180 x 60 x 30 mm



| P (w) | IP | Code        | € HT          |
|-------|----|-------------|---------------|
| 100   | 20 | <b>0685</b> | <b>145,90</b> |

L x l x h = 180 x 90 x 35 mm



| P (w) | IP | Code        | € HT          |
|-------|----|-------------|---------------|
| 180   | 20 | <b>0732</b> | <b>215,20</b> |

L x l x h = 280 x 64 x 31 mm

## Appareils fonctionnant en 24V DC

MEUBLED



EGO



SLIMLED



JAKLED 30/60/65/120



MODULED 24



FLEXI CRISTAL 30/60/120



JAKLED 65 RGB



# ALIMENTATION LED extérieure 24V DC

## Alimentations



| P (w) | IP | Code        | € HT         |
|-------|----|-------------|--------------|
| 30    | 67 | <b>0695</b> | <b>52,60</b> |

L x l x h = 160 x 50 x 40 mm  
 Primaire : câble H05RNF 0,60 m.  
 Secondaire : câble H05RNF 0,60 m.



| P (w) | IP | Code        | € HT          |
|-------|----|-------------|---------------|
| 60    | 67 | <b>0032</b> | <b>103,90</b> |

L x l x h = 240 X 40 X 21 mm  
 Primaire : câble H05RNF 0,50 m.  
 Secondaire : câble H05RNF 0,50 m.



| P (w) | IP | Code        | € HT          |
|-------|----|-------------|---------------|
| 150   | 66 | <b>0033</b> | <b>217,50</b> |

L x l x h = 252 x 68 x 39 mm  
 Primaire : câble H05RNF 0,30 m.  
 Secondaire : câble H05RNF 0,30 m.



| P (w) | IP | Code             | € HT          |
|-------|----|------------------|---------------|
| 320   | 67 | <b>52013</b> (1) | <b>357,00</b> |
| 600   | 67 | <b>52016</b> (2) | <b>663,00</b> |

(1) L x l x h = 252 x 90 x 44 mm  
 (2) L x l x h = 280 x 144 x 49 m  
 Primaire : câble H05RNF 0,30 m.  
 Secondaire : câble H05RNF 0,30 m.

## Appareils fonctionnant en 24V DC

EGO



JAKLED 30/60/65/120



JAKLED 65 RGB



LAMPE

DOWNLIGHT  
ENCASTRE

RAIL  
PROJECTEUR  
SPOTRIE

RÉGLIETTE

RUBAN  
PROFILÉ

APPLIQUE  
PLAFONNIER  
SUSPENSION

EXTÉRIEUR :  
PROJECTEUR

EXTÉRIEUR :  
HUBLOT  
APPLIQUE

EXTÉRIEUR :  
ENCASTRE  
BORNE

ACCESSOIRES

## ALIMENTATION LED - Courant constant 350 mA



| T.B.T | P (w) | IP | Code        | € HT         |
|-------|-------|----|-------------|--------------|
| 350mA | 3,8   | 20 | <b>0728</b> | <b>31,80</b> |

L x l x h = 65 x 39 x 20 mm



| T.B.T | P (w) | IP | Code        | € HT          |
|-------|-------|----|-------------|---------------|
| 350mA | 25    | 20 | <b>0058</b> | <b>135,50</b> |

L x l x h = 130 x 43 x 30 mm.  
Fourni avec connexion, code 2140.  
Variable PWM : variable par bouton poussoir ou commande DALI.



| T.B.T | P (w) | IP | Code        | € HT         |
|-------|-------|----|-------------|--------------|
| 350mA | 4,9   | 20 | <b>0607</b> | <b>28,70</b> |

L x l x h = 73 x 40 x 17 mm



| T.B.T | P (w) | IP | Code         | € HT         |
|-------|-------|----|--------------|--------------|
| 350mA | 7,2   | 20 | <b>52003</b> | <b>22,30</b> |

L x l x h = 118 x 40 x 10 mm



| T.B.T | P (w) | IP | Code        | € HT         |
|-------|-------|----|-------------|--------------|
| 350mA | 15    | 20 | <b>0046</b> | <b>28,60</b> |

L x l x h = 101,5 x 51 x 29,5 mm.  
Variable par coupure de phase.



| T.B.T | P (w) | IP | Code        | € HT          |
|-------|-------|----|-------------|---------------|
| 350mA | 25    | 20 | <b>0034</b> | <b>120,20</b> |

L x l x h = 130 x 43 x 30 mm.  
Variable PWM : variable par bouton poussoir ou commande DALI.

### Série LUCIA 2



Prévoir les accessoires de raccordement.

- Rallonge de 2 m avec connexions, code **1397, 2,30 € HT.**
- Connexions pour 3 spots LUCIA 2 en 350mA, code **2140, 8,40 € HT.**
- Connexions pour 6 spots LUCIA 2 en 350mA, code **2141, 12,70 € HT.**

## ALIMENTATION LED - Courant constant 500 mA



| T.B.T | P (w) | IP | Code         | € HT         |
|-------|-------|----|--------------|--------------|
| 500mA | 12    | 20 | <b>52017</b> | <b>11,20</b> |

Connecteur XL6 au secondaire.  
L x l x h = 111 x 42 x 24 mm

XL6 (6W)



Alimentation avec connexion pour PEARL.



| T.B.T | P (w) | IP | Code        | € HT         |
|-------|-------|----|-------------|--------------|
| 500mA | 12    | 20 | <b>0984</b> | <b>35,60</b> |

L x l x h = 120 x 40 x 20 mm

PEARL 2 (2W)  
500mA



## ALIMENTATION LED - Courant constant 700 mA



| T.B.T | P (w) | IP | Code        | € HT         |
|-------|-------|----|-------------|--------------|
| 700mA | 4,9   | 20 | <b>0638</b> | <b>31,80</b> |

L x l x h = 73 x 40 x 17 mm



| T.B.T | P (w) | IP | Code        | € HT          |
|-------|-------|----|-------------|---------------|
| 700mA | 30    | 20 | <b>0059</b> | <b>146,00</b> |

L x l x h = 207 x 42 x 31 mm  
**Variable PWM : variable par bouton poussoir ou commande DALI.**



| T.B.T | P (w) | IP | Code        | € HT          |
|-------|-------|----|-------------|---------------|
| 700mA | 30    | 20 | <b>0035</b> | <b>130,70</b> |

L x l x h = 207 x 42 x 31 mm.  
**Variable PWM : variable par bouton poussoir ou commande DALI.**

Prévoir les accessoires de raccordement.

- Rallonge de 2 m avec connexions, code **1398, 2,30 € HT.**
- Connexions pour 3 spots 700mA, code **0820, 10,10 € HT.**
- Connexions pour 6 spots 700mA, code **0821, 17,50 € HT.**

## ALIMENTATION LED - Courant constant 800 mA et supérieur



| T.B.T  | P (w) | IP | Code        | € HT         |
|--------|-------|----|-------------|--------------|
| 800mA  | 35    | 20 | <b>0055</b> | <b>37,70</b> |
| 1050mA | 60    | 20 | <b>0052</b> | <b>40,80</b> |

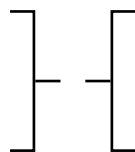

METROPOLIS



# VARIATION LED 24V DC



Module variable PWM. Commande par bouton poussoir à distance. **Alimentation à commander séparément.**

| Référence | P (w) | Dim. (mm)<br>L x l x h | Code         | € HT          |
|-----------|-------|------------------------|--------------|---------------|
| MV100     | 100   | 100x48x28              | <b>50060</b> | <b>163,40</b> |

**Alimentation à commander séparément.**

| P (w) | IP | Code         | € HT         |
|-------|----|--------------|--------------|
| 50    | 20 | <b>0675</b>  | <b>70,40</b> |
| 75    | 20 | <b>52010</b> | <b>79,60</b> |

L x l x h = 180 x 60 x 30 mm

| P (w) | IP | Code        | € HT          |
|-------|----|-------------|---------------|
| 100   | 20 | <b>0685</b> | <b>145,90</b> |

L x l x h = 180 x 90 x 35 mm

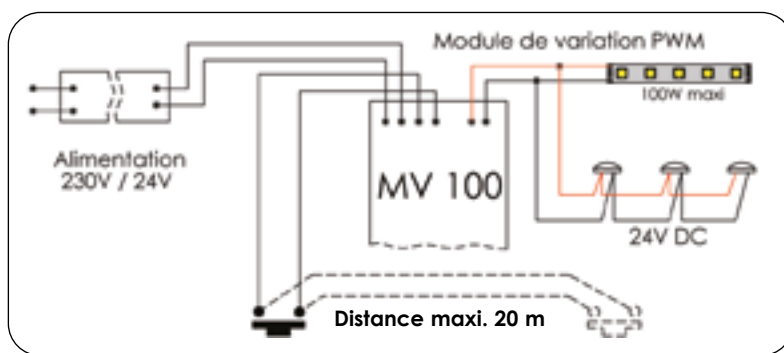



# VARIATION LED COURANT CONSTANT



LAMPE

DOWNLIGHT  
ENCASTRE

RAIL  
PROJECTEUR  
SPOTIERIE

RÉGLLETTE

RUBAN  
PROFILÉ

APPLIQUE  
PLAFONNIER  
SUSPENSION

EXTÉRIEUR :  
PROJECTEUR

EXTÉRIEUR :  
HUBLOT  
APPLIQUE

EXTÉRIEUR :  
ENCASTRE  
BORNE

ACCESSOIRES

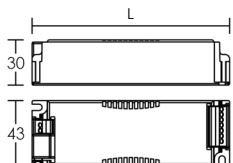
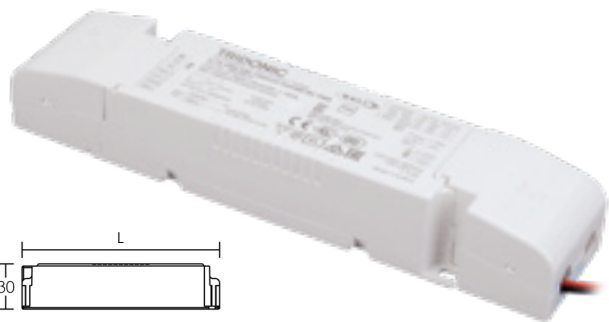

Alimentation pour LED variable PWM. Commande par bouton poussoir à distance.

| Courant  | P (W) | L (mm) | Code        | € HT          |
|--|-------|--------|-------------|---------------|
| <b>Bornier à vis</b>                           |       |        |             |               |
| 350mA  | 25    | 130    | <b>0034</b> | <b>120,20</b> |
| 700mA  | 30    | 207    | <b>0035</b> | <b>130,70</b> |
| <b>Connexion sans outil - Précâblage 0,5 m</b> |       |        |             |               |
| 350mA  | 25    | 130    | <b>0058</b> | <b>135,50</b> |
| 700mA  | 30    | 207    | <b>0059</b> | <b>146,00</b> |

Distance maxi. 20 m

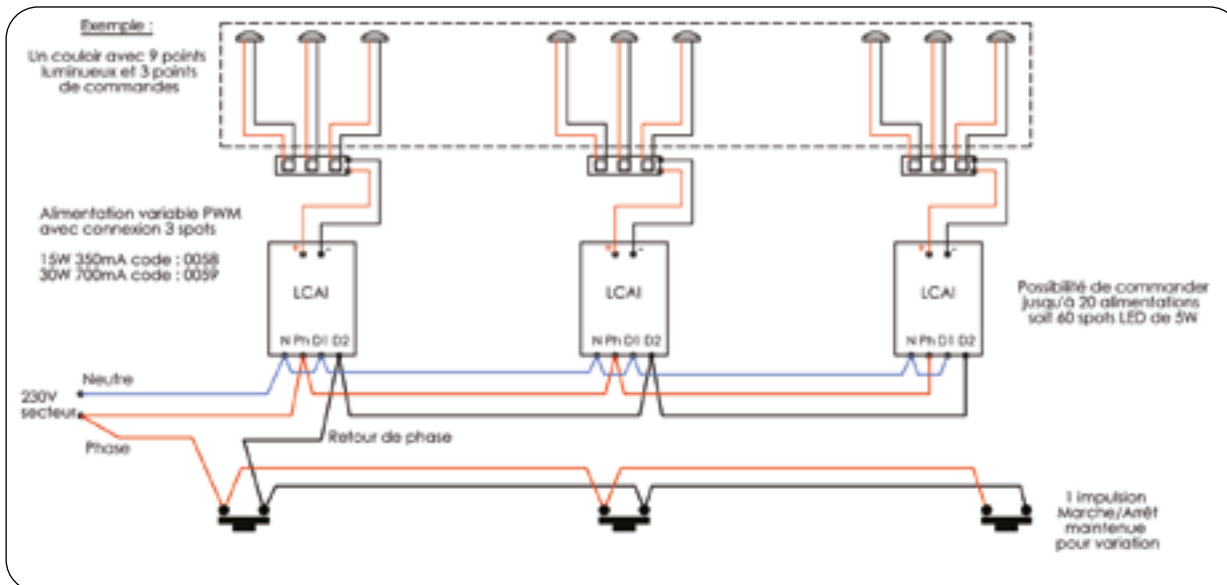
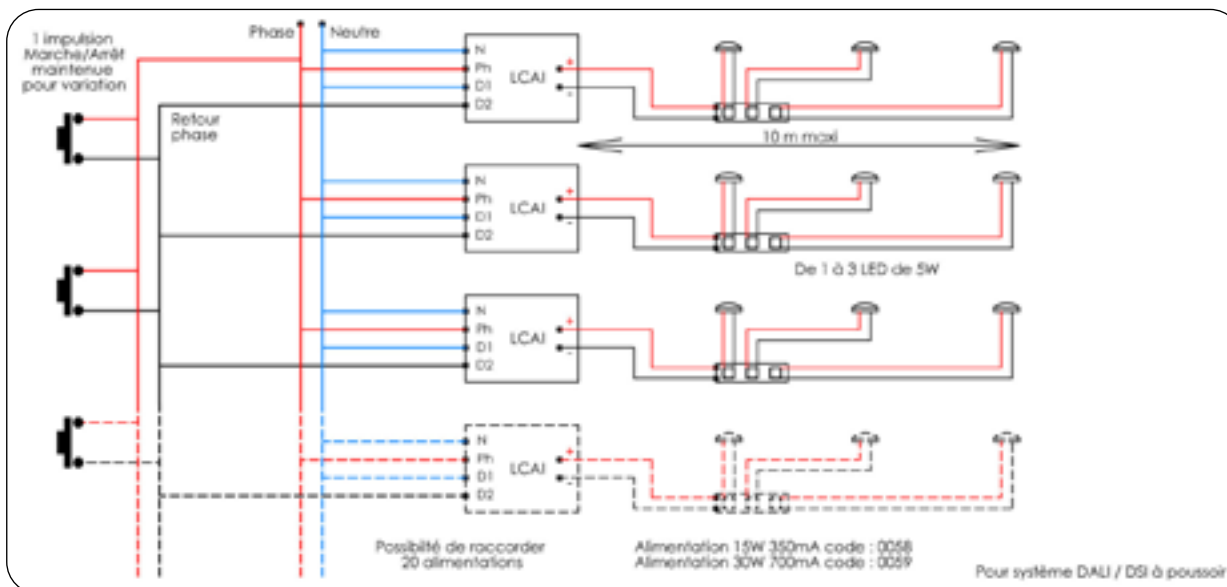

# TRANSFORMATEUR / CONVERTISSEUR ÉLECTRONIQUE

## RAPPEL des recommandations pour l'installation en faux plafond des transformateurs et des convertisseurs électroniques suivant le GUIDE UTE C 15 559

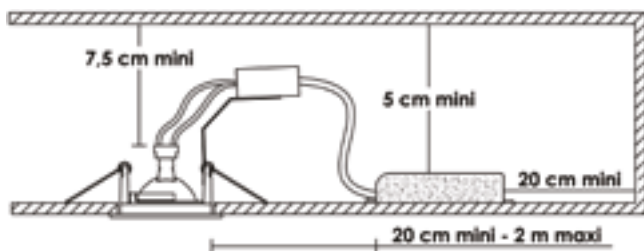

Les convertisseurs électroniques fonctionnent à des fréquences de 35 à 40 KHz.

C'est pourquoi les longueurs de câbles au secondaire ne doivent jamais dépasser **plus de 2 m**.

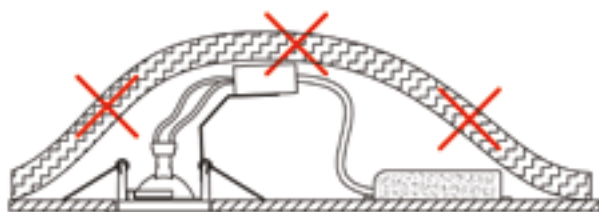

**Ne jamais recouvrir** les spots, les transformateurs, les convertisseurs et les alimentations LED, **de matière isolante**.

Câble, fils sur le secondaire Haute Température résistant à 170°. Section 1,5 mm<sup>2</sup> minimum. Primaire et Secondaire.

### Accessibilité

- 1- **Faux-plafonds démontables** : les transformateurs, les convertisseurs, et les alimentations LED, doivent être **fixés et installés** sur des parties fixes des faux-plafonds.
- 2- **Faux-plafonds non démontable** : il est admis d'introduire un transformateur, un convertisseur ou une alimentation LED, sans les fixer à travers l'orifice de ce faux-plafond destiné à recevoir l'appareil d'éclairage.  
Si le transformateur ou le convertisseur alimente plusieurs appareils, une trappe d'accès est obligatoire.  
Le matériel y compris les appareillages doivent être disposés de façon **à faciliter leur visite, leur entretien et leur remplacement**.

## TRANSFORMATEUR FERROMAGNÉTIQUE

Le guide UTE C15-559 autorise une chute de tension maximale de 5% de la tension nominale afin d'assurer le fonctionnement normal des appareils d'éclairage.

Le guide détermine ainsi directement les longueurs de câble admissibles pour une installation en 12V dans le cas de transformateurs ferromagnétiques. (voir tableau ci-dessous)

| Sections des conducteurs ou fils électriques  |       |                     |                     |                   |                   |
|---|-------|---------------------|---------------------|-------------------|-------------------|
| Longueurs maxi./chute de tension de 5% en 12V |       |                     |                     |                   |                   |
| P (VA)  | I (A) | 1,5 mm <sup>2</sup> | 2,5 mm <sup>2</sup> | 4 mm <sup>2</sup> | 6 mm <sup>2</sup> |
| 20  | 1,7   | 12 m                | 20 m                | 32 m              |                   |
| 50  | 4,2   | 4,8 m               | 8 m                 | 12 m              | 19 m              |
| 60  | 5     | 3,8 m               | 6,3 m               | 10 m              | 15 m              |
| 100   | 8,3   | 2,4 m               | 4 m                 | 6,4 m             | 9,6 m             |
| 150   | 12,5  | 1,6 m               | 2,7 m               | 4,3 m             | 6,4 m             |
| 200   | 16,6  |                     | 2 m                 | 3,2 m             | 4,8 m             |
| 250   | 20,8  |                     | 1,6 m               | 2,6 m             | 3,8 m             |
| 300   | 25    |                     |                     | 2,12 m            | 3,2 m             |

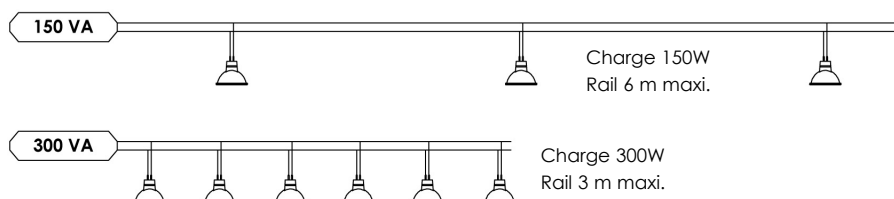

## CONVERTISSEUR ÉLECTRONIQUE DE SÉCURITÉ pour lampe halogène 12V



IP 20



SV

Convertisseur simple bornier.

| Référence | P (w) | Câble       | Code        | € HT         |
|-----------|-------|-------------|-------------|--------------|
| SV        | 20-60 | avec* (HT°) | <b>0642</b> | <b>10,90</b> |
| SV        | 20-60 | sans        | <b>3991</b> | <b>9,70</b>  |

\*fils de 0,4 m de section 1 mm<sup>2</sup>.

IP 20



TP

Convertisseur équipé d'un double bornier de repiquage permettant l'alimentation d'un autre convertisseur.

| Référence | P (w)  | Câble | Code        | € HT         |
|-----------|--------|-------|-------------|--------------|
| TP 105    | 20-105 | sans  | <b>0866</b> | <b>26,20</b> |

IP 44



TB/EL

Convertisseur pour plafond salle d'eau.

| Référence | P (w) | Câble      | Code        | € HT         |
|-----------|-------|------------|-------------|--------------|
| TB/EL*    | 20-60 | avec (HT°) | <b>0649</b> | <b>30,60</b> |

\*Primaire : 1 m câble H05RNF 2x 1,5 mm<sup>2</sup>.  
Secondaire : 0,5 m câble haute température 2x 1,5 mm<sup>2</sup>.  
Boîtiers de raccordement IP44.

## TRANSFORMATEUR DE SÉCURITÉ pour lampe halogène 12V



IP 20

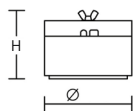

TS

Corps polycarbonate noir. Transformateur torique.

| P (w) | Ø x H (mm) | Poids (kg) | Code        | € HT          |
|-------|------------|------------|-------------|---------------|
| 150   | 115 x 71   | 1,8        | <b>0884</b> | <b>101,70</b> |
| 200   | 115 x 85   | 2,3        | <b>0885</b> | <b>130,90</b> |
| 300   | 135 x 95   | 2,8        | <b>0886</b> | <b>160,60</b> |

IP 44



TB

Transformateur de sécurité pour plafond salle d'eau. Protection thermique.

| Réf. | P (w) | Poids (kg) | Code        | € HT         |
|------|-------|------------|-------------|--------------|
| TB   | 50    | 0,9        | <b>0789</b> | <b>50,40</b> |

Primaire : 1 m câble H05RNF 2x 1,5 mm<sup>2</sup>. Secondaire : 0,5 m câble haute température 2x 1,5 mm<sup>2</sup>. Boîtiers de raccordement IP44.

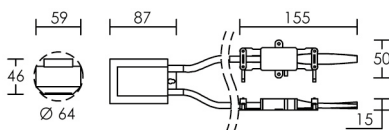
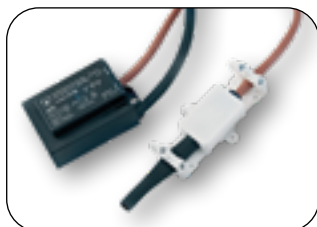

# TRANSFORMATEUR DE SÉCURITÉ pour jardin



230V

12V  
AC

IP  
66

850°C

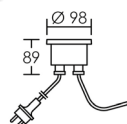

## TJ 60

Transformateur ferromagnétique IP66 + fiche IP44 2P 16A. Câble H05RNF 2x 1 mm<sup>2</sup> : primaire 2,7 m / secondaire 2 m.

| P (w) | IP | Poids (kg) | Code | € HT  |
|-------|----|------------|------|-------|
| 50    | 66 | 1,12       | 0888 | 64,90 |

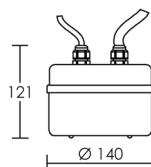

## TJ 300

Transformateur torique. Câble H05RNF primaire/ secondaire 2 m.

| P (w) | IP | Poids (kg) | Code | € HT   |
|-------|----|------------|------|--------|
| 300   | 66 | 3,45       | 0889 | 198,80 |

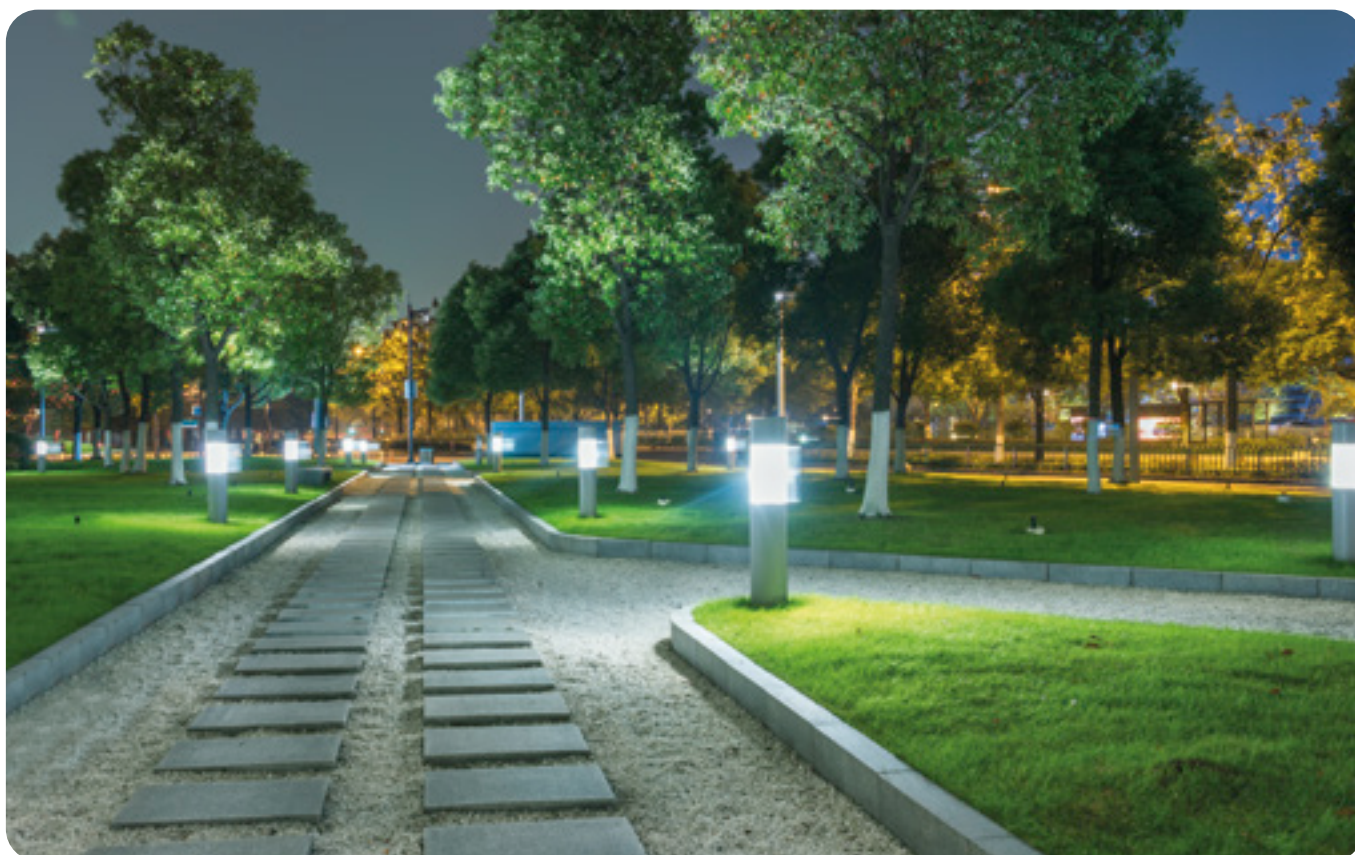

# TRANSFORMATEUR / CONVERTISSEUR DE SÉCURITÉ pour rail 12V

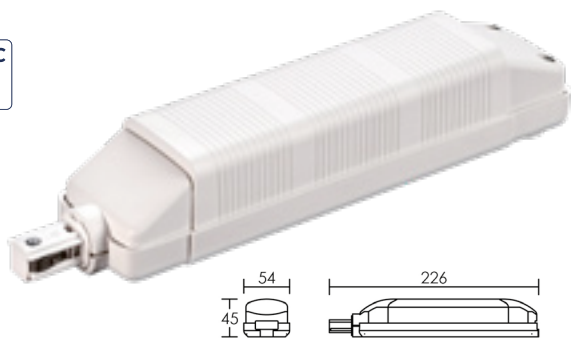

**TL**

Corps polycarbonate. Convertisseur électronique pour rail 12V - 2 m maxi.

| P (W) | Dim. (mm)<br>L x h | Couleur | Code        | € HT          |
|-------|--------------------|---------|-------------|---------------|
| 200   | 226 x 45           | noir    | <b>1536</b> | <b>172,80</b> |
| 200   | 226 x 45           | blanc   | <b>1537</b> | <b>172,80</b> |

Ne pas brancher plus de 3 convertisseurs sur la même ligne utilisant le conducteur neutre. Pour une utilisation intensive, il est conseillé de choisir le modèle DEKO 300.



**DEKO**

Corps polycarbonate. Transformateur torique.

| P (W) | IP | Couleur de la base | Code        | € HT          |
|-------|----|--------------------|-------------|---------------|
| 200   | 20 | noir               | <b>1486</b> | <b>112,80</b> |
| 200   | 20 | blanc              | <b>1485</b> | <b>112,80</b> |
| 300   | 20 | noir               | <b>1560</b> | <b>121,60</b> |
| 300   | 20 | blanc              | <b>1561</b> | <b>121,60</b> |

Commander séparément la **base**, la **coupole**, la ou les **connexions de rails**.

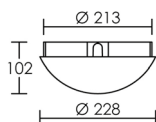

Coupole seule noire.

| Code        | € HT         |
|-------------|--------------|
| <b>1564</b> | <b>16,90</b> |



Coupole seule blanche.

| Code        | € HT         |
|-------------|--------------|
| <b>1565</b> | <b>16,90</b> |

## EXEMPLE DE CONFIGURATION AVEC RAIL TBT 1X 25A

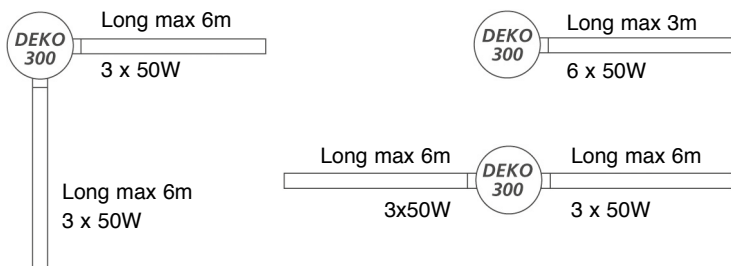

Connexion de rail.

| Couleur | Code        | € HT         |
|---------|-------------|--------------|
| noir    | <b>1552</b> | <b>15,30</b> |
| blanc   | <b>1553</b> | <b>15,30</b> |

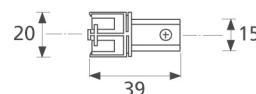

LAMPE  
DOWNLIGHT ENCASTRE  
RAIL PROJECTEUR SPOTIERIE  
RÉGLETTE  
RUBAN PROFILÉ  
APPLIQUE PLAFONNIER SUSPENSION  
EXTÉRIEUR : PROJECTEUR  
EXTÉRIEUR : HUBLOT APPLIQUE  
ACCESSOIRES

## SPOTS POUR RAIL 1 ALLUMAGE

### PROJECTEUR LED

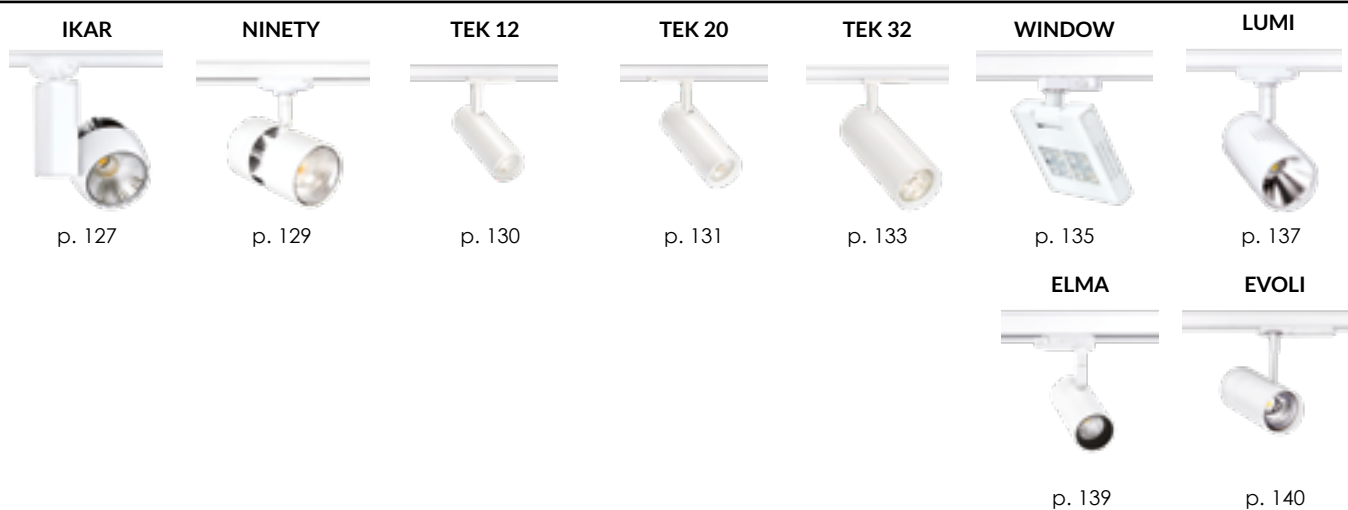

### SPOTERIE

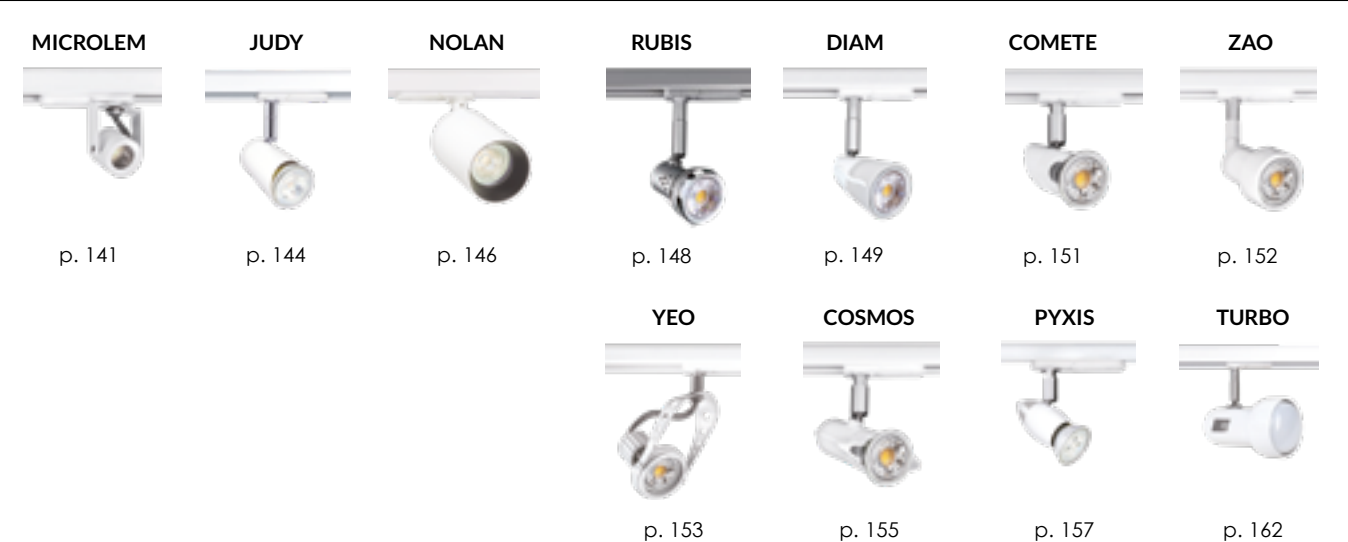

### SUSPENSION



# RAIL 1 ALLUMAGE 230V (modèle 029)

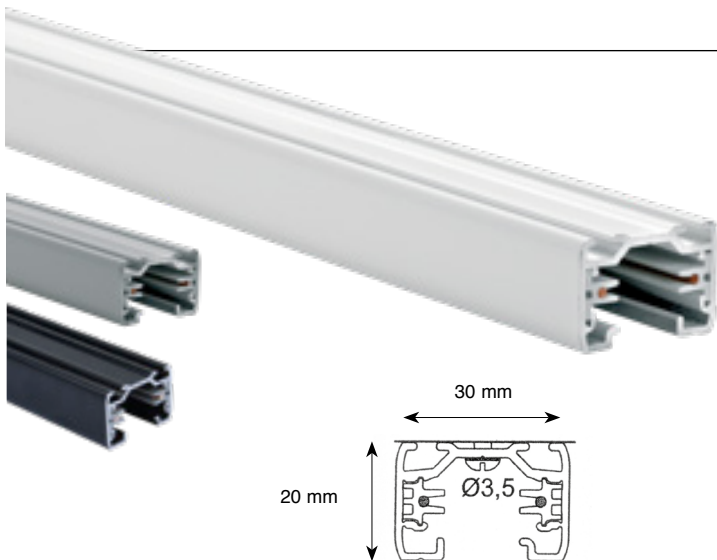

## NOKIA-1 029

Aluminium. 2 conducteurs 4 mm<sup>2</sup>. 1 neutre/1 phase + terre - 16A, 3,7kW.

| Référence | Long. | Couleur | Code | € HT  |
|-----------|-------|---------|------|-------|
| GB 2100   | 1 m   | blanc   | 1645 | 36,30 |
| GB 2200   | 2 m   | blanc   | 1646 | 72,60 |
| GB 2100   | 1 m   | gris    | 1613 | 36,30 |
| GB 2200   | 2 m   | gris    | 1614 | 72,60 |
| GB 2100   | 1 m   | noir    | 1631 | 36,30 |
| GB 2200   | 2 m   | noir    | 1632 | 72,60 |

### Alimentation droite



| Coul. | Code | € HT  |
|-------|------|-------|
| blanc | 1647 | 12,90 |
| noir  | 1615 | 12,90 |

### Alimentation gauche



| Coul. | Code | € HT  |
|-------|------|-------|
| blanc | 1648 | 12,90 |

### Alimentation centrale



| Coul. | Code | € HT  |
|-------|------|-------|
| blanc | 1649 | 32,20 |
| noir  | 1616 | 32,20 |

### Raccord en ligne



| Coul. | Code | € HT |
|-------|------|------|
| blanc | 1650 | 8,90 |
| noir  | 1617 | 8,90 |

### Embout fermeture



| Coul. | Code | € HT |
|-------|------|------|
| blanc | 1657 | 3,20 |
| noir  | 1620 | 3,20 |

### Raccord orientable



| Coul. | Code | € HT  |
|-------|------|-------|
| blanc | 1651 | 51,70 |
| noir  | 1618 | 51,70 |

### Coude 90° GB 34



| Coul. | Code | € HT  |
|-------|------|-------|
| blanc | 1652 | 43,60 |

### Raccord en T



| Réf. | Code | € HT  |
|------|------|-------|
| GB37 | 1653 | 59,40 |
| GB40 | 1654 | 59,40 |

### Croix GB 38



| Coul. | Code | € HT  |
|-------|------|-------|
| blanc | 1655 | 77,40 |

### Suspension



| Code | € HT  |
|------|-------|
| 1658 | 29,10 |

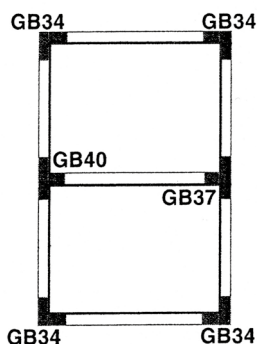

### Raccord fileté



| Code | € HT |
|------|------|
| 1660 | 4,10 |

M 10 pas de 1 mm.

### Adaptateur (> 10 kg)



| Coul. | Code | € HT  |
|-------|------|-------|
| blanc | 1656 | 19,40 |
| gris  | 1619 | 19,40 |
| noir  | 1633 | 19,40 |

### Adaptateur (< 10 kg)



| Coul. | Code | € HT  |
|-------|------|-------|
| blanc | 1606 | 16,30 |
| gris  | 1604 | 16,30 |
| noir  | 1605 | 16,30 |

### Adaptateur compact (> 10 kg)



| Coul. | Code  | € HT  |
|-------|-------|-------|
| blanc | 16100 | 14,00 |
| noir  | 16101 | 14,00 |

## SPOTS POUR RAIL 3 ALLUMAGES

### PROJECTEUR LED



### SPOTERIE

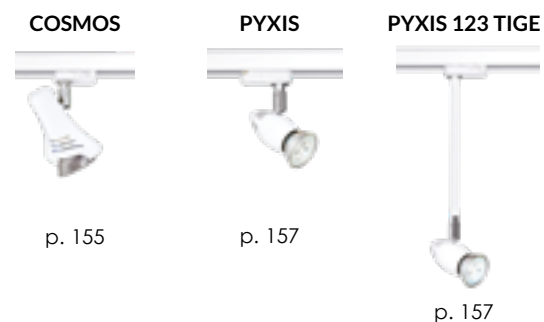

### SUSPENSION

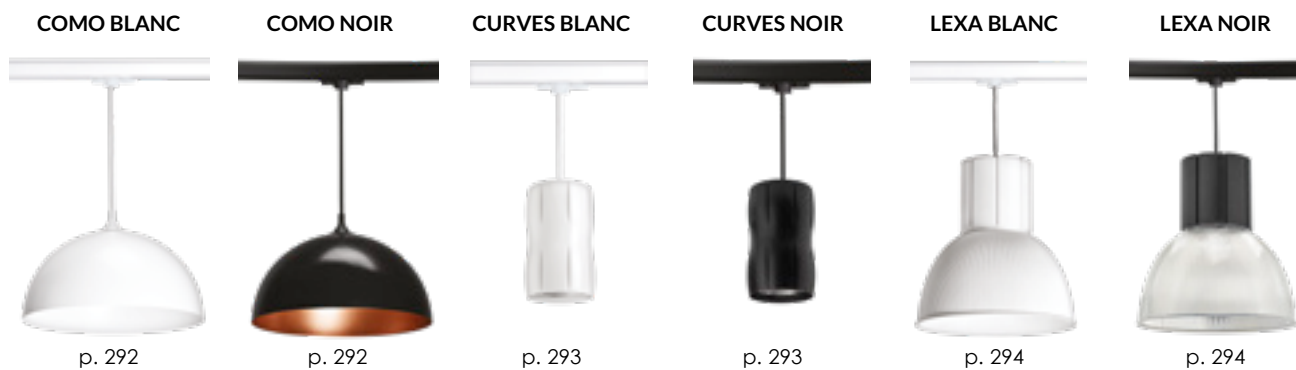



# RAIL 3 ALLUMAGES 230V (modèle 023)

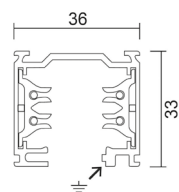
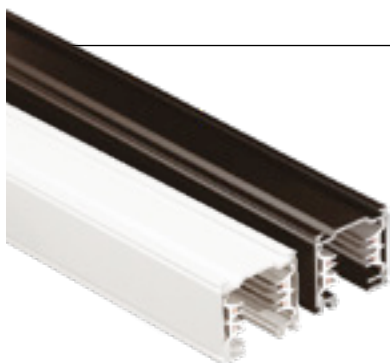

Corps aluminium/4 conducteurs/1 neutre 3 phases + terre - 16A, 3,7 kW.

| L (m) | Code<br>BLANC | € HT   | Code<br>NOIR | € HT   |
|-------|---------------|--------|--------------|--------|
| 1     | 16114         | 35,90  | 16113        | 35,90  |
| 2     | 16124         | 71,00  | 16123        | 71,00  |
| 3     | 16134         | 105,30 | 16133        | 105,30 |

## Alimentation droite

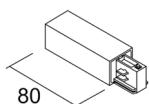

| Coul. | Code  | € HT  |
|-------|-------|-------|
| blanc | 16347 | 14,70 |
| noir  | 16346 | 14,70 |

## Alimentation gauche

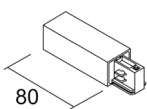

| Coul. | Code  | € HT  |
|-------|-------|-------|
| blanc | 16349 | 14,70 |
| noir  | 16348 | 14,70 |

## Adaptateur

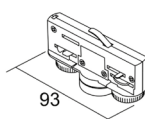

| Coul. | Code  | € HT  |
|-------|-------|-------|
| blanc | 16341 | 17,10 |
| noir  | 16340 | 17,10 |

## Embout de fermeture

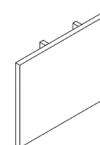

| Coul. | Code  | € HT |
|-------|-------|------|
| blanc | 16355 | 1,60 |
| noir  | 16354 | 1,60 |

## Coude à 90° terre intérieure

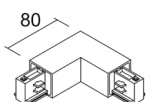

| Coul. | Code  | € HT  |
|-------|-------|-------|
| blanc | 16351 | 31,00 |
| noir  | 16350 | 31,00 |

## Coude à 90° terre extérieure

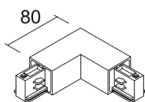

| Coul. | Code  | € HT  |
|-------|-------|-------|
| blanc | 16353 | 31,00 |
| noir  | 16352 | 31,00 |

## Jonction linéaire

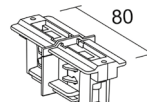

| Coul. | Code  | € HT  |
|-------|-------|-------|
| blanc | 16343 | 10,60 |
| noir  | 16342 | 10,60 |

## Kit suspension

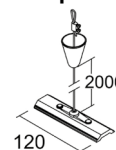

| Coul. | Code  | € HT |
|-------|-------|------|
| blanc | 16345 | 9,00 |
| noir  | 16344 | 9,00 |

## Connexion en T terre droite

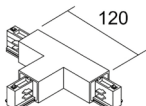

| Coul. | Code  | € HT  |
|-------|-------|-------|
| blanc | 16358 | 48,10 |
| noir  | 16357 | 48,10 |

## Connexion en T terre gauche

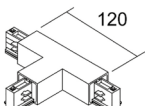

| Coul. | Code  | € HT  |
|-------|-------|-------|
| blanc | 16360 | 48,10 |
| noir  | 16359 | 48,10 |

## Fixation plafond

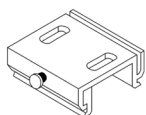

| Code  | € HT |
|-------|------|
| 16356 | 7,30 |

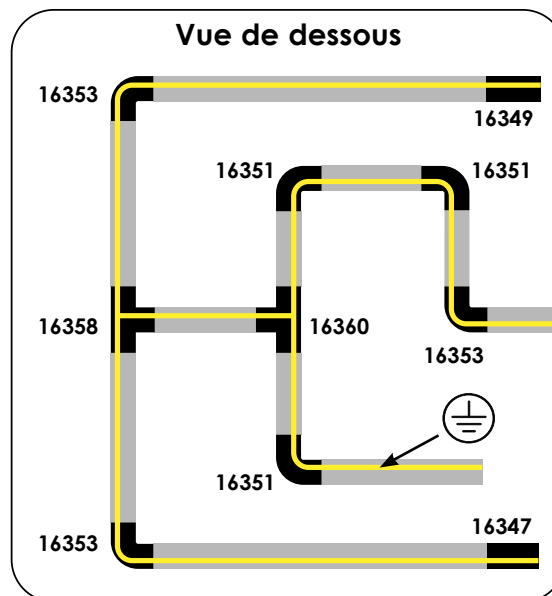

## RL 2



| IP | Code        | € HT         |
|----|-------------|--------------|
| 68 | <b>0743</b> | <b>13,80</b> |

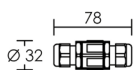

Raccord 2 câbles.  
Inclus les bornes de raccordement électrique  
et des joints ronds à composition permettant  
de raccorder des câbles de Ø6 à Ø11.  
Câble recommandé : de H05 RN-F 2 x 1 mm<sup>2</sup>  
à H07 RN-F 3 x 1,5 mm<sup>2</sup>.

## RL 3



| IP | Code        | € HT         |
|----|-------------|--------------|
| 68 | <b>0739</b> | <b>31,40</b> |

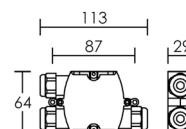

Raccord 3 câbles.  
Inclus les bornes de raccordement électrique  
et des joints ronds à composition permettant  
de raccorder des câbles de Ø6 à Ø11.  
Câble recommandé : de H05 RN-F 2 x 1 mm<sup>2</sup>  
à H07 RN-F 3 x 1,5 mm<sup>2</sup>.

## Exemples de montage

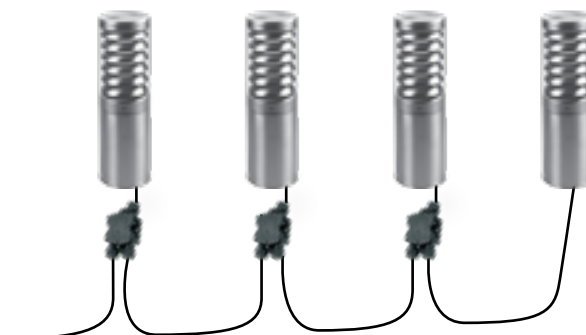
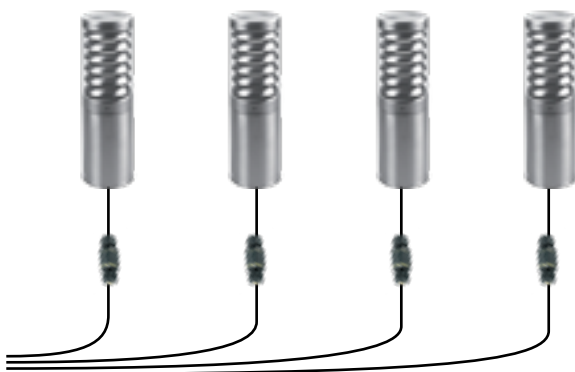

## Ces accessoires conviennent pour :



### TWISTER 3

Code : 50833  
p. 300



### SUNNY

Code : 50298  
p. 393



### NEWAY

Code : 4020  
p. 395



### MORPHIS

Code : 50296  
p. 392



### CALEO 1

Code : 3134  
p. 402



### KADO

Code : 1893  
p. 401

## B1



Encastrable directement dans les plafonds et les murs en maçonnerie et béton armé. Excellent élément de protection pour installation traditionnelle en faux plafond. Pour spot à lampe 230V GU10 50W max. alimenté directement sans transformateur. Accepte des luminaires de découpe :  
 Ø mini. : 50 mm  
 Ø max. : 103 mm  
 haut max. : 100 mm  
 Ne pas encastrer de transformateur, ni de convertisseur dans cette boîte B1.

Tenue au feu 850°

### TEK PF 03

Code € HT  
 1790 20,50



### Outil fixe-boîte

Code € HT  
 1791 49,90

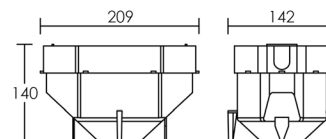

## B2



Emplacement prévu pour recevoir un convertisseur électronique, code 0642. Pour lampe 50W max. Accepte des luminaires de découpe :  
 Ø mini. : 50 mm  
 Ø max. : 103 mm  
 haut maxi. : 100 mm.

### TEK PF 03T

Code € HT  
 1950 34,90

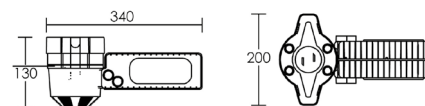

## B20



Corps en polycarbonate. Pour lampe 75W max. Accepte des luminaires de découpe :  
 Ø mini. : 60 mm  
 Ø maxi. : 125 mm  
 haut maxi. : 90 mm.

Convient pour MINI START.

### TEK PF 05

Code € HT  
 1951 21,80

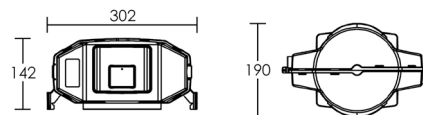

## B30



Corps en polycarbonate. Accepte des luminaires de découpe :  
 Ø mini. : 100 mm  
 Ø maxi. : 210 mm  
 haut maxi. : 100 mm.  
 Convient pour START 230 Electronique.

### TEK PF 06 T

Code € HT  
 1952 70,70

### Grille en option

Code € HT  
 1953 11,80

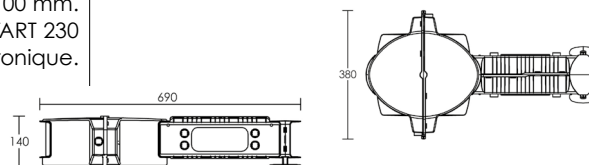

## PIÈCES DÉTACHÉES

### TÉLÉCOMMANDE



Code 0131 Télécommande de recharge pour projecteur TWISTER 2 et TWISTER 3 SENSOR

Code 0133 Télécommande de recharge pour projecteur MICHELLE

### SENSOR DE RECHANGE



Code 50787 Détecteur crépusculaire infrarouge détachable pour projecteur MICHELLE

### CIRCUIT LED

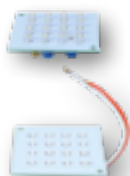

**DINA**  
Code **Circuit de 16 LED pour DINA**  
2103 LED couleur Blanc (pour 0508)  
2104 LED couleur Bleu (pour 0509)  
0500 Jeu de 2 ressorts (pour 0508 et 0509)

**DINO**  
Code **Circuit de 16 LED pour DINO**  
2107 LED couleur Blanc (pour 0514)  
2108 LED couleur Bleu (pour 0515)  
0500 Jeu de 2 ressorts (pour 0514 et 0515)

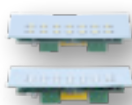

**CERO**  
Code **Circuit de 14 LED pour CERO**  
2110 LED couleur Blanc (pour 0525)  
2111 LED couleur Bleu (pour 0526)  
0519 Jeu de 2 ressorts (pour 0525 et 0526)

**CARO**  
Code **Circuit de 18 LED pour CARO**  
2112 LED couleur Blanc (pour 0527)  
2113 LED couleur Bleu (pour 0528)  
0564 Jeu de 2 ressorts (pour 0527 et 0528)

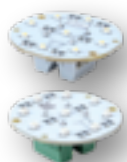

**EGO et BOLO**  
Code **Circuit de 9 LED pour EGO et BOLO**  
1274 LED couleur Blanc chaud (pour 1757/1814)  
1214 LED couleur Bleu (pour 1758/1815)  
1215 LED couleur Rouge (pour 1759)

**SUKO**  
Code **Circuit de 52 LED avec Driver**  
2091 LED couleur Blanc (pour 0300)

### BALLAST ÉLECTRONIQUE

Code 0455 Ballast 18W pour WALKER 3  
  
0522 Ballast 18/24W pour ONDINE, POP, H2O  
0533 Ballast 14/21W pour POP

### AMORCEUR

Code 1683 Amorceur universel 3 fils pour appareil 70W, 150W, 250W et 400W



## DOUILLE - CONNEXION



| Code | UE |
|------|----|
| 1257 | 1  |
| 0805 | 1  |
| 0799 | 1  |
| 0809 | 10 |
| 1502 | 1  |
| 0830 | 5  |
| 1504 | 1  |
| 0531 | 1  |
| 1328 | 1  |
| 0532 | 1  |

- (1)- **Douille** E27 avec support pour WALKER 1, 2 et 3
- **Douille universelle** T.B.T avec fil silicone 120 mm (G4, G5.3, Gy6.35)
- **Douille universelle** T.B.T avec fil silicone 150 mm
- (2)- **Douille** T.B.T pour spot Skylab Explorer Héliostat fil avec Téflon 120 mm
- (3)- **Douille** GU10 et **connexion sans outil** (support court)
- (4)- **Douille** GU10 pour DISK, GALAXY
- (5)- **Douille** GU10 et **connexion sans outil** pour TIPO, SPEED (sans support)
- (6)- **Douille G5 pour MF**
- (7)- **Douille** S14d de sécurité pour lampe **54011**
- (8)- **Porte starter pour MF**

## CLIP - RESSORT

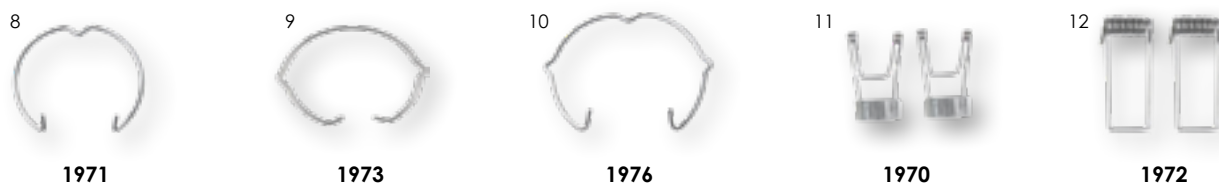

| Code | UE |
|------|----|
| 1971 | 10 |
| 1973 | 10 |
| 1976 | 10 |
| 1970 | 10 |
| 1972 | 10 |

- (8)- **Clips** de tenue de lampe dia 50 mm pour spot SATURNE avec clip reposant sur 3 picots
- (9)- **Clips** de tenue de lampe dia 50 mm pour FIXO LUNAR 50 et spot SATURNE avec clip reposant dans 2 fentes
- (10)- **Clips** de tenue de lampe dia 63 mm pour OMEGA GAMMA
- (11)- **Ressort** fixation pour SATURNE
- (12)- **Ressort** fixation pour FIXO LUNAR 50 DISK GALAXY

## TRANSFORMATEUR - CONVERTISSEUR



| Code | UE |
|------|----|
| 0870 | 1  |
| 1222 | 1  |
| 0866 | 1  |

- (13)- **Transformateur** pour spot SKYLAB EXPLORER HÉLIOSTAT
- (14)- **Transformateur** pour AQUASOL et HYDROSTAR
- (15)- **Convertisseur** pour Barre 2 spots B2 ET Barre 3 spots B3







# TIGES ET FIXATIONS POUR PROJECTEURS

|   |                 | Projecteurs compatibles     |                           |                           |                         |                   |              |              |                         |
|---|-----------------|-----------------------------|---------------------------|---------------------------|-------------------------|-------------------|--------------|--------------|-------------------------|
| Couleur   | Code accessoire | TWISTER 3<br>p.300<br>à 307 | MICHELLE<br>p.309         | SUNSET<br>p.310<br>et 311 | WINK<br>p.312<br>et 313 | ELFI<br>p.314     | TAG<br>p.316 | DIA<br>p.317 | ZURO<br>p.318<br>et 319 |
| <b>Tige standard 0,40 m</b> (p. 310 - 311)  |                 |                             |                           |                           |                         |                   |              |              |                         |
|    | ● blanc         | 1637                        |                           |                           | ✓                       |                   |              |              |                         |
|   | ● noir          | 1636                        |                           |                           | ✓                       |                   |              |              |                         |
| <b>Tige FA40</b> (p. 304 - 312)   |                 |                             |                           |                           |                         |                   |              |              |                         |
|    | ● gris          | 50487                       | 12W - 25W<br>45W          |                           |                         |                   |              |              |                         |
|   | ● blanc         | 50149                       |                           |                           |                         | 10W<br>20W<br>30W | ✓            |              |                         |
|   | ● noir          | 50076                       | 12W - 25W<br>45W          | 30W - 50W                 |                         | 10W<br>20W<br>30W | ✓            |              |                         |
| <b>Tige FA40 EXPO</b> (p. 263 - 304)  |                 |                             |                           |                           |                         |                   |              |              |                         |
|    | ● gris          | 50488                       | 12W - 25W<br>45W          |                           |                         |                   |              |              |                         |
|   | ● blanc         | 50451                       |                           |                           |                         | 10W<br>20W<br>30W | ✓            |              |                         |
|   | ● noir          | 50594                       | 12W - 25W<br>45W          | 30W - 50W                 |                         | 10W<br>20W<br>30W | ✓            |              |                         |
| <b>Tige FA57</b> (p. 316)   |                 |                             |                           |                           |                         |                   |              |              |                         |
|   | ● blanc         | 3144                        |                           |                           |                         |                   | ✓            | ✓ (include)  |                         |
|   | ● noir          | 3145                        |                           |                           |                         |                   | ✓            | ✓ (include)  |                         |
| <b>Fixation mât simple / double Ø60 mm</b> (p. 304)   |                 |                             |                           |                           |                         |                   |              |              |                         |
|    | ● gris          | 50863                       | 180W<br>250W              |                           |                         |                   |              |              |                         |
|   |                 | 50861                       | 25W<br>45W<br>70W<br>100W |                           |                         |                   |              |              |                         |
|   | ● noir          | 50862                       |                           |                           |                         |                   |              |              |                         |
| <b>Rallonge pour fixation côte à côte (jusqu'à 4 proj.)</b> (p. 304)<br>Uniquement compatible avec projecteurs TWISTER 3 HP + fixation <b>50863</b> |                 |                             |                           |                           |                         |                   |              |              |                         |
|    | ● gris          | 50864                       | 180W<br>250W              |                           |                         |                   |              |              |                         |
| <b>Patère</b> (p. 316)  |                 |                             |                           |                           |                         |                   |              |              |                         |
|    | ● blanc         | 0196                        |                           |                           |                         |                   | ✓            |              |                         |
|   | ● noir          | 0197                        |                           |                           |                         |                   | ✓            |              |                         |
| <b>Bras déportés - x2</b> (p. 319)  |                 |                             |                           |                           |                         |                   |              |              |                         |
|    | ● beige         | 0971                        |                           |                           |                         |                   |              |              | ✓                       |
|   | ● gris          | 0941                        |                           |                           |                         |                   |              |              | ✓                       |
|   | ● blanc         | 1169                        |                           |                           |                         |                   |              |              | ✓                       |
|   | ● noir          | 1191                        |                           |                           |                         |                   |              |              | ✓                       |
|   | ● gris foncé    | 1196                        |                           |                           |                         |                   |              |              | ✓                       |
|   | ● RAL au Choix  | 1309                        |                           |                           |                         |                   |              |              | ✓                       |
| <b>Piquet jardin</b> (p. 34)  |                 |                             |                           |                           |                         |                   |              |              |                         |
|    | ● gris          | 50489                       | 12W - 25W<br>45W          | 10W - 30W                 |                         |                   |              |              |                         |

# GLOSSAIRE DES SYMBOLES NORMATIFS













## Indice IP

Premier chiffre caractéristique : degré de protection contre la pénétration de corps solides.

| IP    | TEST  | Description   | NF EN 60 598  | UTE C15-103 |
|-------|---|---|---|-------------|
| IP 2X |  Ø12 mm  | La partie électrique du luminaire est protégée contre les <b>corps solides supérieurs à 12 mm</b> (doigt de la main). |   |             |
| IP 3X |  Ø2,5 mm | La partie électrique du luminaire est protégée contre les <b>corps solides supérieurs à 2,5 mm</b> .                  |   | AE2         |
| IP 4X |  Ø1 mm   | La partie électrique du luminaire est protégée contre les <b>corps solides supérieurs à 1 mm</b> .                    |   | AE3         |
| IP 5X |          | La partie électrique du luminaire est protégée contre les <b>poussières</b> .   |  | AE4         |
| IP 6X |          | La partie électrique du luminaire est totalement protégée contre les <b>poussières</b> .                              |  | AE5         |

## Indice IP

Deuxième chiffre caractéristique : degré de protection contre la pénétration de corps liquides.











| IP    | TEST  | Description  | NF EN 60 598  | UTE C15-103 |
|-------|---|--|---|-------------|
| IP X1 |   | Le luminaire est protégé contre les chutes verticales de gouttes d'eau.                    |   | AD2         |
| IP X2 |  | Le luminaire est protégé contre les chutes d'eau jusqu'à 15° par rapport à la verticale.   |   |             |
| IP X3 |  | Le luminaire est protégé contre les chutes d'eau jusqu'à 60° par rapport à la verticale.   |   | AD3         |
| IP X4 |  | Le luminaire est protégé contre les chutes d'eau de toutes les directions.                 |  | AD4         |
| IP X5 |  | Le luminaire est protégé contre les jets d'eau à la lance de toutes les directions.        |  | AD5         |
| IP X6 |  | Le luminaire est protégé contre les jets d'eau à la lance assimilables aux paquets de mer. |   | AD6         |
| IP X7 |  | Le luminaire est protégé contre les effets de l'immersion entre 0,15 et 1m.                |  | AD7         |
| IP X8 |  | Le luminaire est protégé contre les effets de l'immersion sous pression.                   |  | AD8         |

## Indice IK

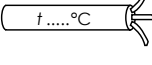

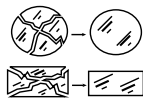
Degré de protection procuré par les enveloppes contre les chocs mécaniques externes.

|       |                   |       |     |
|-------|-------------------|-------|-----|
| IK 02 | (150 g à 133 mm)  | 0,2 j | AG1 |
| IK 07 | (500 g à 400 mm)  | 2 j   | AG2 |
| IK 08 | (1700 g à 300 mm) | 5 j   | AG3 |
| IK 10 | (5000 g à 400 mm) | 20 j  | AG4 |

## Indications - Recommandations

|   |   |
|---|---|
|    | Luminaire ne pouvant pas être recouvert de matériau isolant thermique.  |
| $t_a \dots \text{°C}$   | Température assignée maximale ambiante.   |
| $t_c \dots \text{°C}$   | Température maximale du boîtier.  |
|    | L'appareil peut être monté dans un meuble constitué d'un matériau normalement inflammable.  |
|    | L'appareil peut être monté dans ou sur un meuble dont le degré d'inflammabilité de la matière n'est pas connue.                                 |
|    | Température de surface du déclenchement de la sécurité.   |
|    | Emploi d'un câble d'alimentation d'interconnexion résistant à la chaleur (exemple : 170)  |
|    | Luminaires pour conditions sévères d'emploi.  |
|    | Remplacement de tout écran de protection fissuré.   |
|   | Ce symbole placé sur le luminaire indique qu'il n'y a pas de verre de protection et que l'on doit utiliser les lampes halogènes basse pression. |
|  | Ce symbole indique qu'il faut impérativement avoir un verre de protection sur le luminaire.   |
|  | Avertissement contre l'usage des lampes faisceau froid (réflecteur dichroïque interdit).  |
|  | Distance minimale des objets éclairés.  |

## Classe d'isolation électrique selon la norme NF C 71 000

| Symbole   | Classe | Définition   |
|---|--------|--|
|  | 1      | Le luminaire possède une isolation fonctionnelle avec une borne de terre, liaison équipotentielle.                     |
|  | 2      | Le luminaire possède une isolation renforcée sans partie métallique accessible. Double isolation sans mise à la terre. |
|  | 3      | Le luminaire fonctionne en très basse tension de sécurité (TBTS). Tension inférieure à 50 V.                           |

## GLOSSAIRE DES PICTOGRAMMES



### Produit fabriqué en France.

La plupart de nos produits indiquant ce pictogramme sont également élaborés en France.



### Classe énergétique du produit

selon le règlement N°874/2012.



### Produit intégrant un circuit LED ou fourni avec une lampe LED.



L'**UGR** est une mesure définie par la CIE dans son rapport technique CIE 117-1995 qui indique le taux d'éblouissement produit par la luminosité des systèmes d'éclairage dans un environnement donné. Plus sa valeur est faible, plus l'installation est confortable. Voir norme EN12464-1.



**FLICKER FREE.** Produit dont les LED n'émettent pas de scintillement. Permet de garantir un meilleur confort visuel.

## Variation



**Produit dimmable**, pouvant fonctionner sur variateur, ce qui permet de moduler l'intensité de l'éclairage. **Plusieurs types de variation existent.**



**Produit STEP DIM**, intégrant la possibilité de varier l'intensité de la lumière par paliers, par simple pression sur interrupteur. Ne fonctionne pas sur variateur.

## Gestion couleur de la lumière



**Produit permettant de régler la température de couleur par télécommande.**



**Produit programmable** grâce à un séquenceur, permettant de régler la couleur de la lumière, autour du spectre des trois couleurs primaires (Rouge - Vert - Bleu).



**Produit permettant de sélectionner la température de couleur** de la lumière par curseur (CCT Change).

## Détection



**Produit à détection de mouvement.**



**Produit à détection de mouvement et crépusculaire.**



**Produit à détection crépusculaire.**



**Produit à détection d'ouverture/fermeture de porte.**



**Produit intégrant la fonction Veille.**

## Préconisations d'installation



**Produit permettant de répondre aux exigences de l'Arrêté du 27 décembre 2018** relatif à la prévention, à la réduction et à la limitation des nuisances lumineuses. (voir détails p. 298)



**Produit répondant aux exigences de la loi Handicap 2015** (selon l'arrêté du 8 décembre 2014).



**Produit pouvant être installé sous ou dans un meuble.** Répond aux spécificités afférentes à la protection anti-feu.



**Produit préconisé pour utilisation intérieure.**



**Produit préconisé pour utilisation extérieure.**

## Contraintes produits



**Poids maximum statique** applicable sur l'appareil.



**Température maximale de la surface** de l'appareil engendrée par la source lumineuse.



**Passage de véhicule autorisé**  
Vitesse maximale de passage.

## Personnalisation (sur commande)



**Produit pouvant être commandé à vos couleurs.** A vous de nous indiquer le RAL souhaité.

## Spécifique ruban/profilé



**Ruban pouvant être recoupé** selon section précisée.



**Produit pouvant être commandé à vos mesures.**

A vous de nous indiquer la longueur souhaitée, dans la limite des pas du produit.



# GLOSSAIRE DES PICTOGRAMMES

## Classe d'isolation électrique

Se conformer à la norme NFC 71 000.



**Classe 1** : le luminaire possède une isolation fonctionnelle avec une borne de terre, liaison équipotentielle.



**Classe 2** : le luminaire possède une isolation renforcée sans partie métallique accessible. Double isolation sans mise à la terre.



**Classe 3** : le luminaire fonctionne en très basse tension de sécurité (TBTS). Tension inférieure à 50V.

## Tension / Courant électrique



**Produit 230V direct** ou fourni avec alimentation pour raccordement direct.



**Produit 24V**, nécessite une alimentation appropriée



**Produit 12V**, nécessite une alimentation appropriée



**Produit à courant constant**, nécessite une alimentation appropriée

## Isolation bâtiment



**Produit adapté à la réglementation thermique 2012 (RT2012)**, imposant notamment une isolation du luminaire à l'air et permettant l'installation de l'appareil dans les bâtiments basse consommation (BBC).



**Produit pouvant être recouvert** de tout type d'isolant, laine de verre et isolant soufflé inclus.



**Produit pouvant être recouvert** d'isolant rouleau uniquement. N'accepte pas les isolants soufflés.



**Produit ne pouvant pas être recouvert** de matériau isolant thermique.



**Produit répondant aux critères de réaction au feu** (test au fil incandescent).

## Installation simplifiée



**Produit à raccordement facile, sans outil.** Connexion / bornier ne nécessitant pas d'outil.



**Repiquage possible.** Produit avec bornier double permettant la réalisation d'un circuit de plusieurs produits.



**Produit à collerette/anneau 1/4 de tour.**



**Produit à collerette/anneau clipsable.**



**Produit à collerette/anneau aimanté(e).**

## Indice IP selon NF EN 60598

**Degré de protection contre la pénétration des corps solides et poussières, ainsi que des liquides.**

Voir détail des indices p. 447.



Application Extérieur : IP standard.



Application Salle d'Eau : IP avec représentation de gouttes d'eau.



Cas des Projecteurs : IP différent sur face éclairante (recto) et verso.



Cas des Encastrés : IP différent sur face éclairante et partie encastrée.



Cas des Hublots : IP différent si installation au Mur (Applique) ou installation Plafond (Plafonnier).



Cas des produits immergeables : produit totalement immergeable.

## Indice IK selon NF EN 50102



**Degré de protection procuré par les enveloppes contre les chocs mécaniques externes.**

Voir détail des indices p. 447.

## Volumes pour Salles d'eau

Se conformer à la norme NFC 15-100 partie 7-701.



**Produit utilisable en Salle d'eau** selon conditions définies dans la norme. Voir détails p. 453.

## Volumes pour Piscines et Bassins

Se conformer à la norme NFC 15-100 partie 7-702.



**Produit utilisable en Piscines et Bassins** selon conditions définies dans la norme. Voir détails p. 452.

## Spécifique extérieur



**Produit résistant au Test de Brouillard Salin.** Evaluation de la résistance à la corrosion des matériaux métalliques comme décrite par la norme EN ISO 9227.

## INSTALLATION ET ENTRETIEN des encastrés de sol, bornes et lampadaires

Pour les appareils encastrés dans le sol, l'installation doit être faite avec un maximum de soin en respectant les instructions de montage, et les règles de l'art de l'installation électrique suivant la norme **NF C 15-100**.

### INSTALLATION

- › Pour tous les appareils, il est indispensable de créer un **drainage efficace** (sable gravier de 25 à 30 cm), pour éviter la formation d'eau stagnante au fond du puits des appareils.
- › Le raccordement des appareils doit être réalisé en **câble souple type H07 RNF**. Cela afin de faciliter l'entretien de l'appareil et d'éviter aussi l'effort sur les presse-étoupes pendant l'installation (Prévoir 30 à 50 cm de câble en fond de puits). **Notez que la condensation peut avoir comme origine le câble lui-même si l'appareil est raccordé avec du câble rigide.**

### INSTALLATION ET REMPLACEMENT DE LAMPE

- › **Ne jamais intervenir sous la pluie ou par temps de brouillard.**
- › Pour extraire le verre (l'écran), utiliser exclusivement un tournevis plat ou une ventouse.
- › Allumer le projecteur et le laisser fonctionner afin d'**assécher l'atmosphère interne** pour éviter toute condensation ultérieure sur le verre ou l'écran.
- › Nettoyer parfaitement les joints, le verre, l'écran, les pas de vis... il est indispensable que la base sur laquelle s'appuie le joint, soit **parfaitement propre**. Enduire la visserie de graisse neutre afin de mieux assurer le remplacement des lampes ou des composants.
- › **Respecter l'ordre de montage** des joints, du verre et de la couronne, positionner le verre ou l'écran correctement dans le bon sens. Respecter l'orientation du bloc optique en cas d'éclairage asymétrique.
- › Serrer les vis progressivement, décalées en quinconce (utiliser l'outil adapté à la tête de vis).
- › Veiller impérativement à ce que la glace ou l'écran du luminaire encastré **ne soit pas recouvert de feuilles, sable boue, écorces...**

**REPLACEMENT IMPÉRATIF DU VERRE, DE L'ÉCRAN S'IL EST CASSÉ OU ÉBRÉCHÉ, ET DES JOINTS ENDOMMAGÉS OU USÉS.**

### CONSIGNES EN CAS DE PROBLÈME (avant appel du fabricant)

#### INTRODUCTION D'EAU

##### Due à la condensation :

- › Sécher l'appareil en respectant les 9 points ci-dessus.
- › Vérifier le câble d'alimentation exclusivement du câble souple.

##### Due à la surchauffe :

- › Voir les détériorations : écran, ballast, amorceur, douille...
- › Vérifier la tension d'alimentation, le positionnement du branchement 230-240-250V.
- › Vérifier la bonne installation du luminaire dans un lit de gravier périphérique.



- › Une surtension de 10% provoque une élévation de température supérieure à 20% et divise la durée de vie des composants et des lampes par deux.
- › Une installation dans la terre ou la tourbe provoque une élévation de température très importante.

## ENTRETIEN

L'entretien des encastrés de sol est **indispensable pour garantir leurs performances**, mécaniques, électriques et photométriques. Cette maintenance est préconisée à **chaque changement de lampe** ou au **minimum tous les ans**. À noter pour les sites exposés (fortement pollués, bord de mer, etc.), un entretien plus rapproché s'impose.



- ➔ **Inox 304 : ne convient pas en milieu salin.**
- ➔ **Inox 316 : convient en milieu salin sous réserve d'un entretien approprié et régulier plusieurs fois par an** (cf. kit de nettoyage).

### QUELQUES RÈGLES SIMPLES

- Repérer les réglages et inclinaison afin de repositionner correctement le luminaire après la maintenance.
- Verre : vérifier son état (cassée ou point de chauffe anormale).
- Câble : si le projecteur est en façade, vérifier que le câble ne facilite pas le cheminement de l'eau (aménagement goutte d'eau).
- Presse-étoupe : vérifier l'état du serrage. Contrôler l'état de corrosion et de fixation de tous les éléments extérieurs du projecteur.
- Enlever les obstacles accumulés, nettoyer, graisser si besoin.
- **RAPPEL : ne jamais intervenir sous la pluie ou par temps de brouillard.**

## GARANTIE

La **garantie est valable** à condition que les instructions de montage et d'installation **soient suivies**, ainsi que l'entretien **tous les six mois** du lavage des surfaces, de la verrerie et de la révision des parties électriques.

La **garantie n'est pas valable** pour les dommages sur la peinture dus au mauvais emploi, abus ou accident qui entraîne une **corrosion excessive**. Les dommages ou ce qui dérive des actes de vandalisme sont de toute façon exclus. La garantie des luminaires ne couvre pas les désastres naturels.

AVANT / APRÈS



Kit d'entretien et de rénovation de l'INOX comprenant :

➔ **2 éponges de polissage + 1 agent actif**

Application préconisée **tous les 6 mois** pour conserver les caractéristiques esthétiques de l'INOX.

Code € HT  
2166 59,10

## VOLUMES DES PISCINES ET DES BASSINS

Pour toute installation, se conformer à la norme NF C 15-100. Partie 7-702

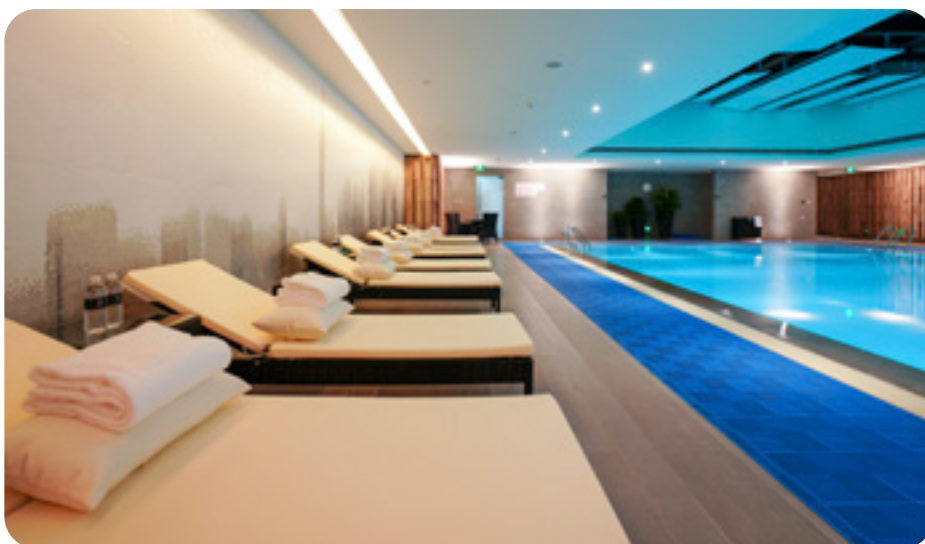
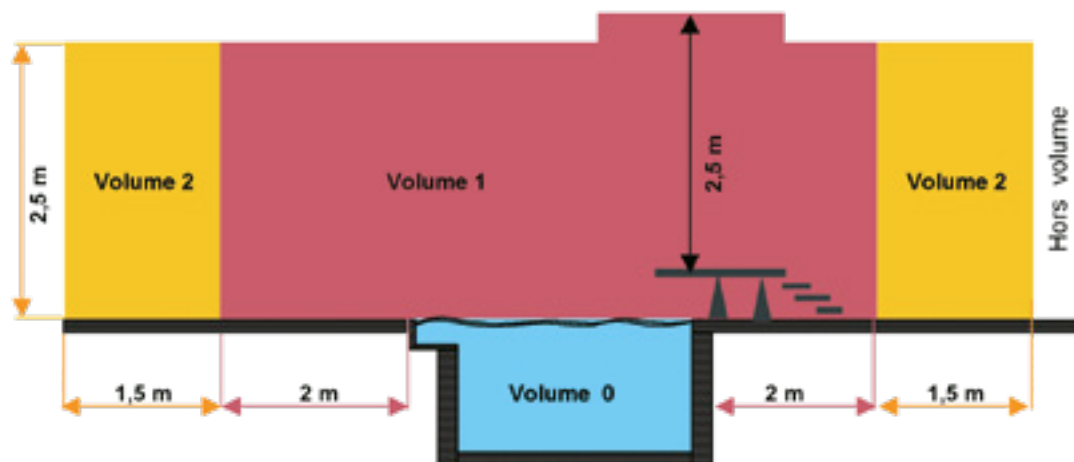

### VOLUME 0

Ce volume comprend l'intérieur du bassin, ses ouvertures dans les parois ou le fond et les pédiluves.  
**Seuls sont autorisés les luminaires IPX8 de classe 3 alimentés en TBTS limités à 12V en courant alternatif ou 30V en courant continu.**

L'alimentation doit toujours être installée en dehors des volumes 0, 1 et 2.

### VOLUME 1

Ce volume est limité par :  
 - le volume 0 ;  
 - le plan vertical situé à 2 m des bords du bassin ;  
 - un plan horizontal situé à 2,5 m du sol ou de la surface.

**Seuls sont autorisés les luminaires IPX5 de classe 3 alimentés en TBTS limités à 12V en courant alternatif ou 30V en courant continu.**

L'alimentation doit toujours être installée en dehors des volumes 0, 1 et 2.

### VOLUME 2

Ce volume est limité par :  
 - le plan vertical extérieur du volume 1 et le plan parallèle situé à 1,5 m de ce dernier  
 - le sol ou la surface sur un plan horizontal situé à 2,5 m au dessus du sol.

**Sont autorisés les luminaires de :**

- classe 3 alimenté en TBTS,
- classe 2 - 230V,

**Ces appareils doivent avoir un degré de protection minimal de :**

- IP X2 pour les piscines à l'intérieur des bâtiments,
- IP X5 pour les piscines à l'extérieur des bâtiments ou si présence de jet d'eau pour nettoyage.

L'alimentation doit toujours être installée en dehors des volumes 0, 1 et 2.

# VOLUMES DES SALLES D'EAU

Pour toute installation dans une salle d'eau, se conformer impérativement à la norme NFC 15-100 partie 7-701.

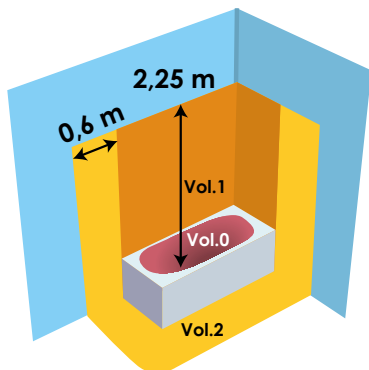

**Cas d'une salle d'eau avec baignoire**  
2,25 m mini au fond de la baignoire.

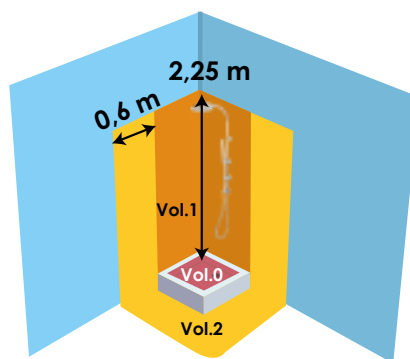

**Cas d'une salle d'eau avec receveur ou bac**  
2,25 m mini au fond du receveur.

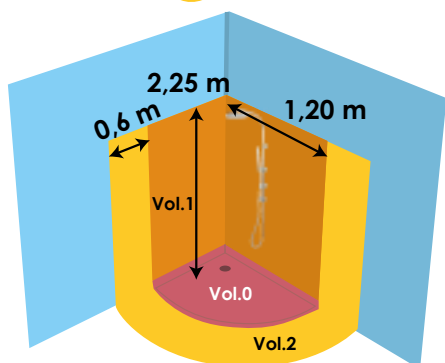

**Cas d'une douche à l'italienne**  
2,25 m mini du sol fini.

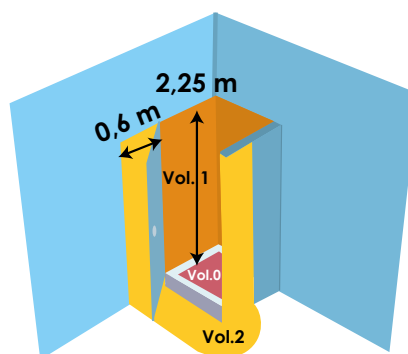

**Cas d'une douche avec paroi ou cloison et porte**  
2,25 m mini du fond du receveur ou sol fini.

## VOLUME 0

C'est le volume intérieur de la baignoire ou du receveur de douche. Pour les douches de plain-pied à l'italienne (sans receveur), il est délimité par le fond de la douche et le plan horizontal situé 10 cm au dessus du point le plus haut du fond de la douche et en partie latérale par les limites du volume 1.

**Sont autorisés les luminaires IPX7 de classe 3 alimentés en TBTS limitée à 12V en courant alternatif 30V en courant continu alimentés en T.B.TS.**

L'alimentation de sécurité doit être installée en dehors des volumes 0, 1 et 2.

## VOLUME 1

C'est le volume délimité en partie latérale :

- par les bords extérieurs de la baignoire ou du receveur de douche,
- pour les douches de plain-pied à l'italienne (sans receveur), par le cylindre vertical de rayon 1,20 m et dont l'axe passe par le centre de la tête de douche, par le point-raccord du flexible de douchette ou par l'ensemble des points constituant le périmètre extérieur de la douche pluie,
- pour les douches à jet horizontaux, les parois faisant obstacle aux jets.

Sa hauteur est limitée par le plus élevé des plans horizontaux suivants, soit au-dessus du volume 0 jusqu'à 2,25 m au dessus du sol fini ou du fond de la baignoire si celui-ci est au dessus du sol fini, soit au-dessus de la douche de tête.

Dans le cas de douche à têtes multiples, le volume 1 est délimité par l'ensemble des volumes individuels définis depuis chaque tête ou flexible

**Sont autorisés les luminaires de classe 3 alimentés en TBTS limitée à 12V courant alternatif ou 30V courant continu - IP X4 ou, IP X5 en présence de jets horizontaux pour raison de nettoyage, et les luminaires autorisés en volume 1.**

L'alimentation doit être installée en dehors des volumes 0, 1 et 2.

## VOLUME 2

C'est le volume situé à 0,6 m du bord du volume 1. La limite en hauteur est identique à celle du volume 1.

La limite basse est celle du sol fini.

**Sont autorisés les luminaires de classe 2 - 230V et protégés par disjoncteur différentiel résiduel de 30 mA max - IP X4 ou, IP X5 en présence de jets horizontaux pour raison de nettoyage, et les luminaires autorisés en volume 1.**

L'alimentation doit être installée en dehors des volumes 0, 1 et 2.

## HORS VOLUMES

C'est le volume situé en dehors des volumes 0, 1, et 2.

## NOTES

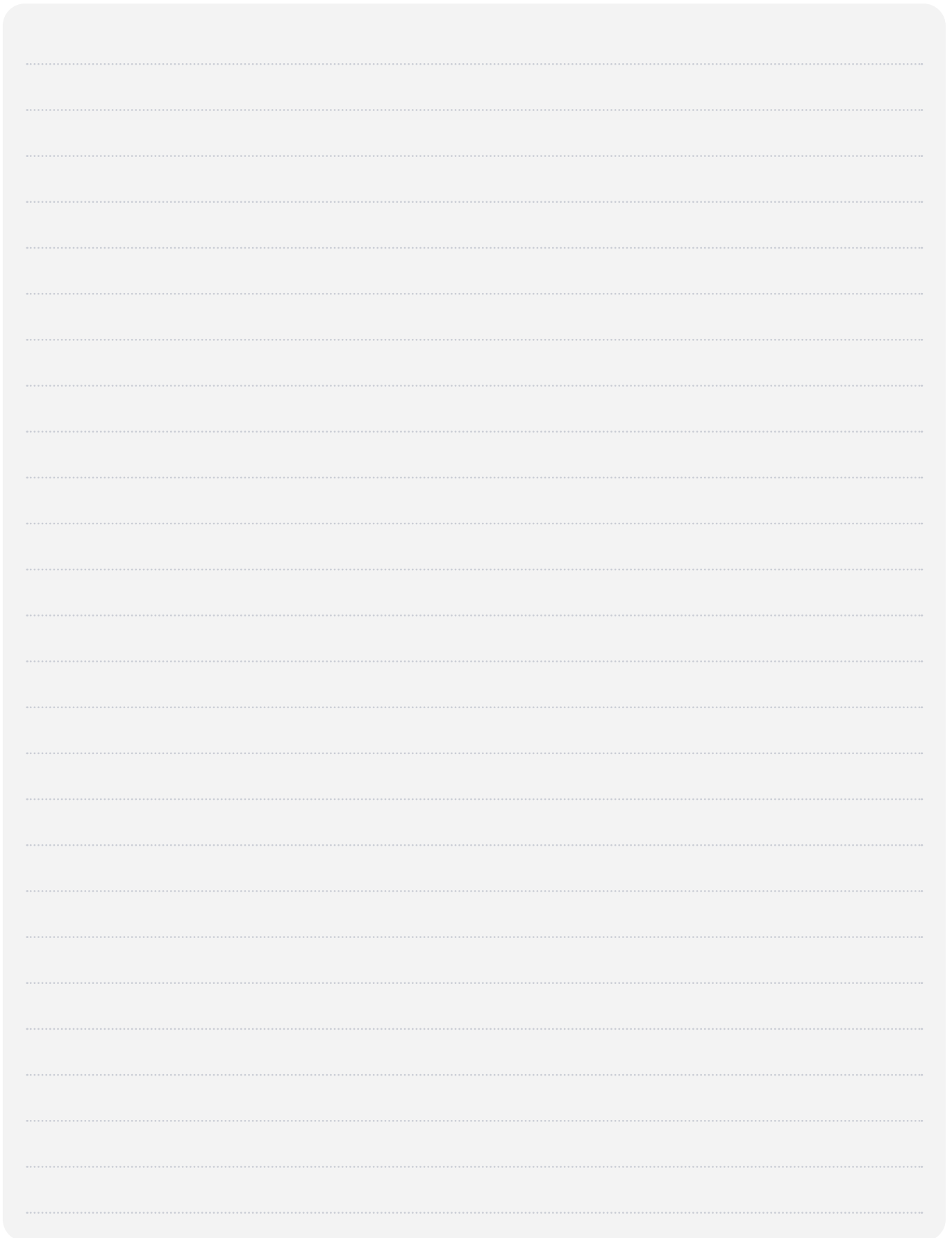

A large, light gray rounded rectangle containing numerous horizontal dotted lines for writing notes.

## NOTES

A large, light gray rectangular area with rounded corners, containing numerous horizontal dotted lines for writing notes.

## NOTES

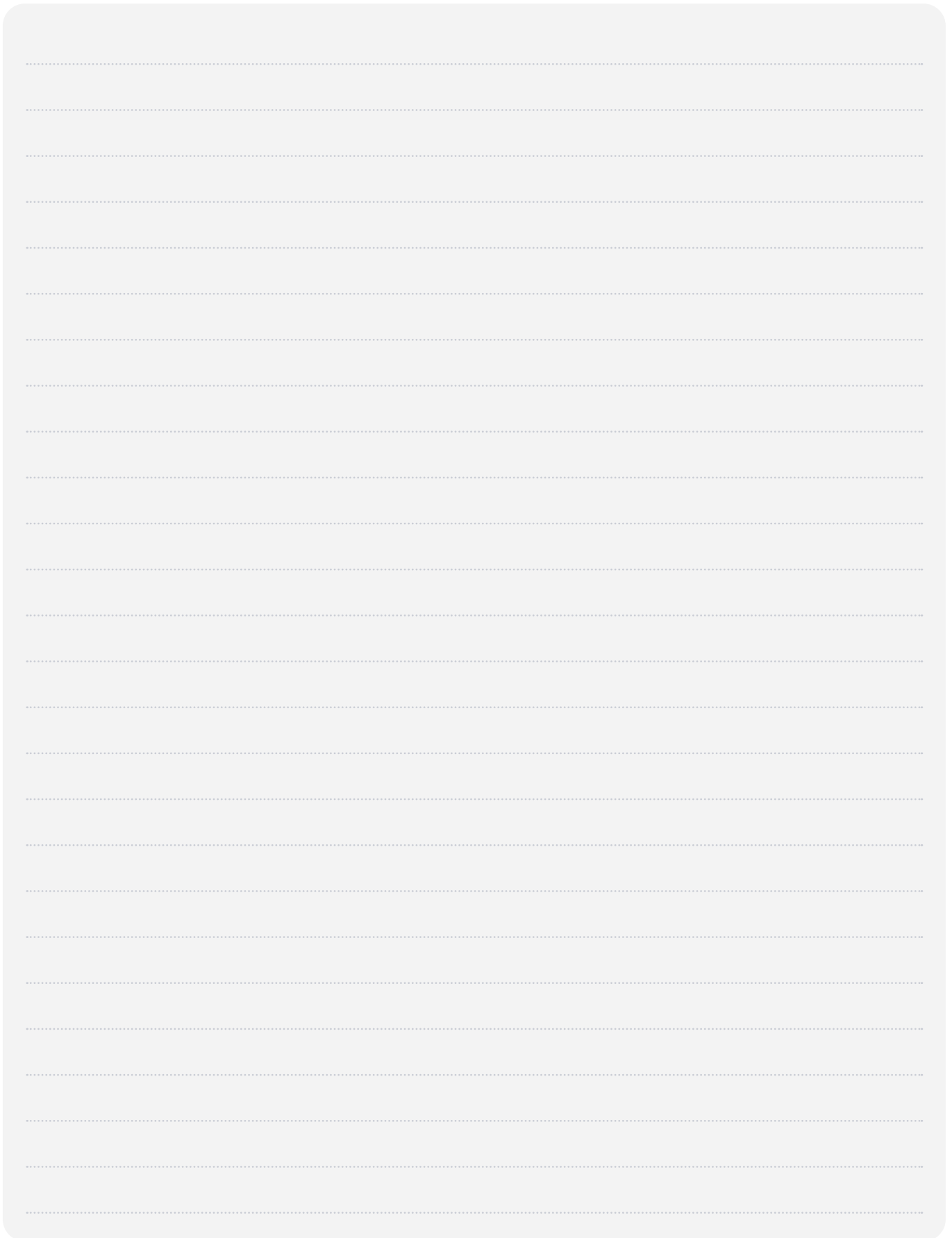

A large, light gray rounded rectangle containing horizontal dotted lines for writing notes. The lines are evenly spaced and extend across the width of the rectangle.



## NOTES

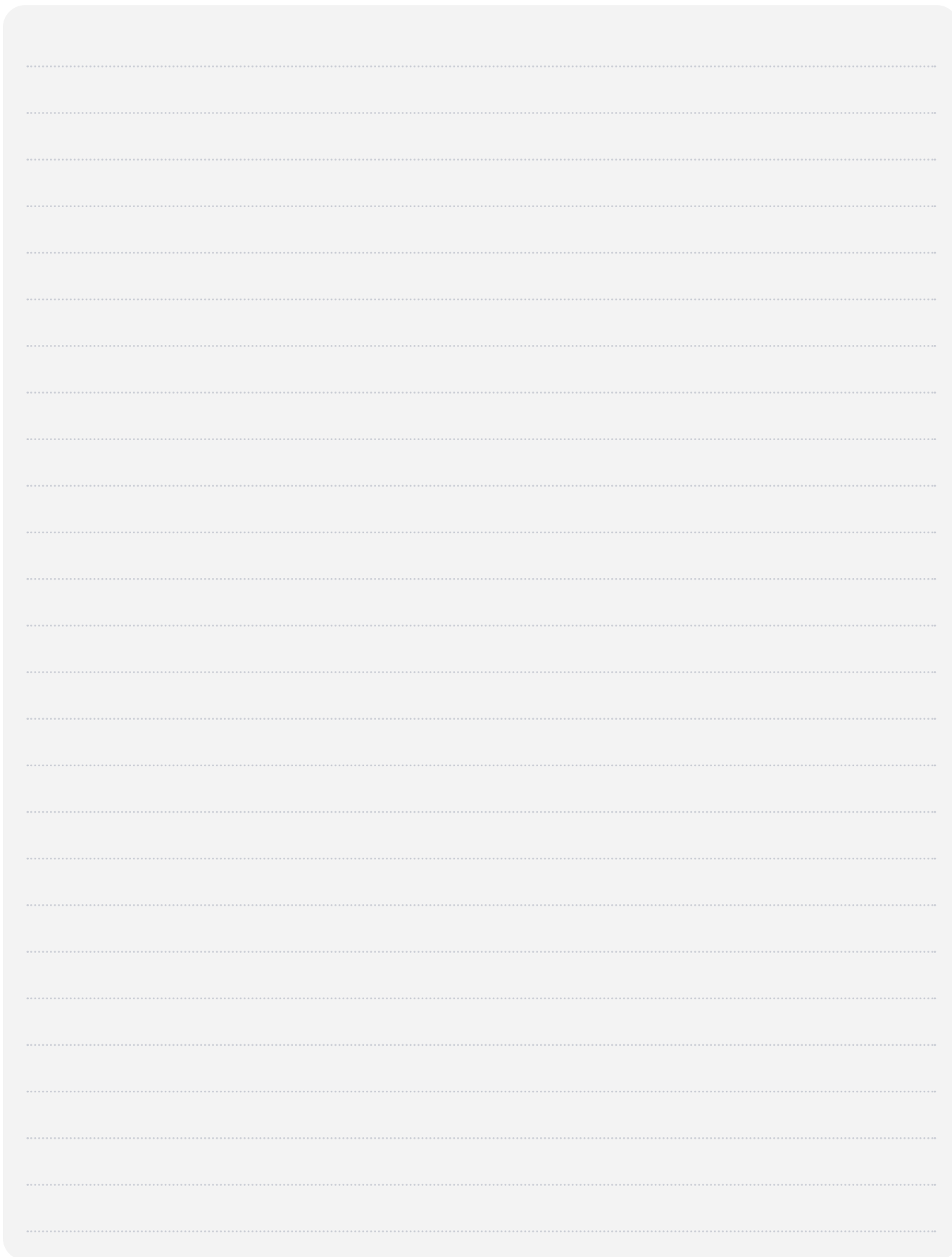

## NOTES

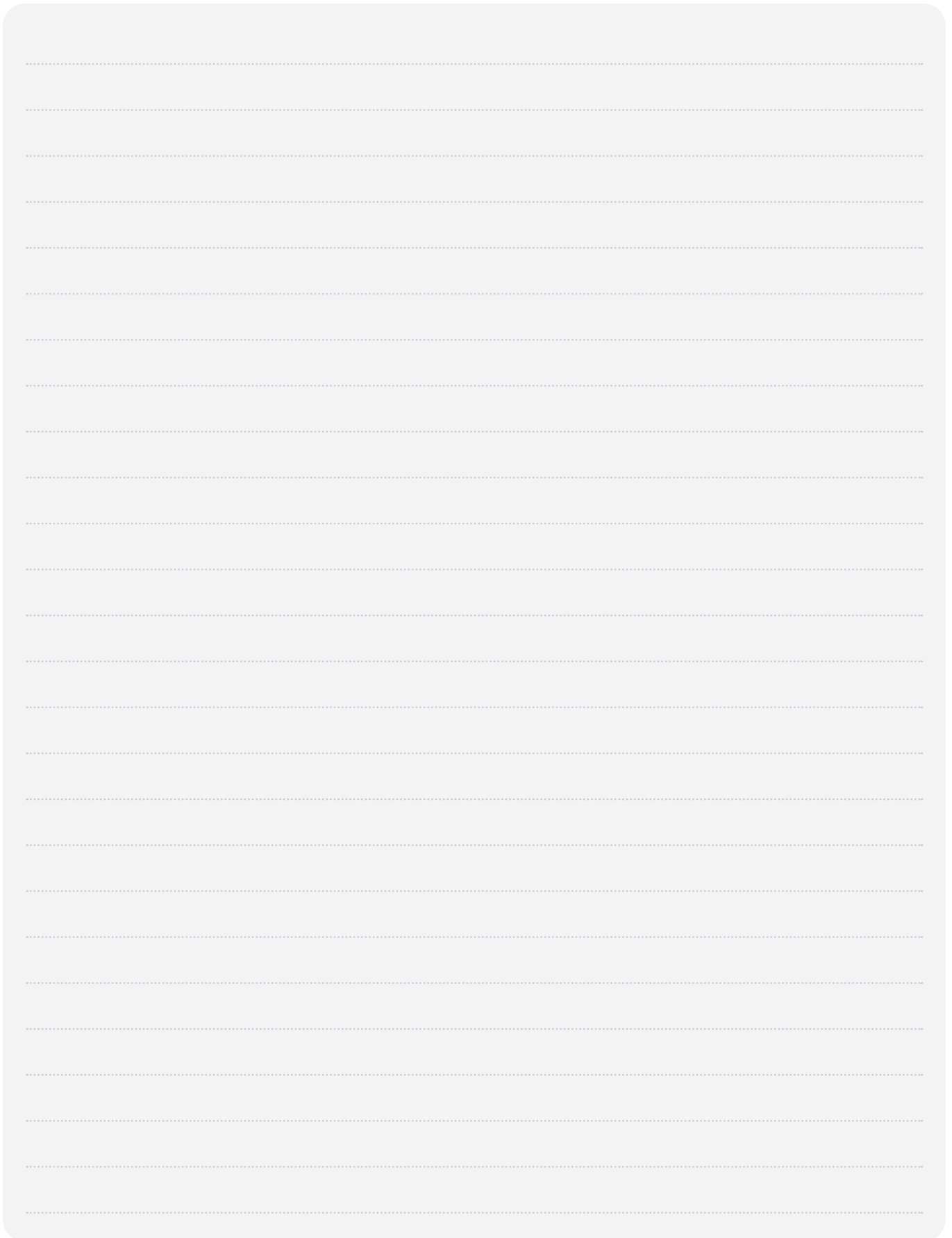

A large, light gray rounded rectangle containing horizontal dotted lines for writing notes. The lines are evenly spaced and extend across the width of the rectangle, providing a template for handwritten text.

## NOTES

A large, light gray rectangular area with rounded corners, containing numerous horizontal dotted lines for writing notes.

## NOTES

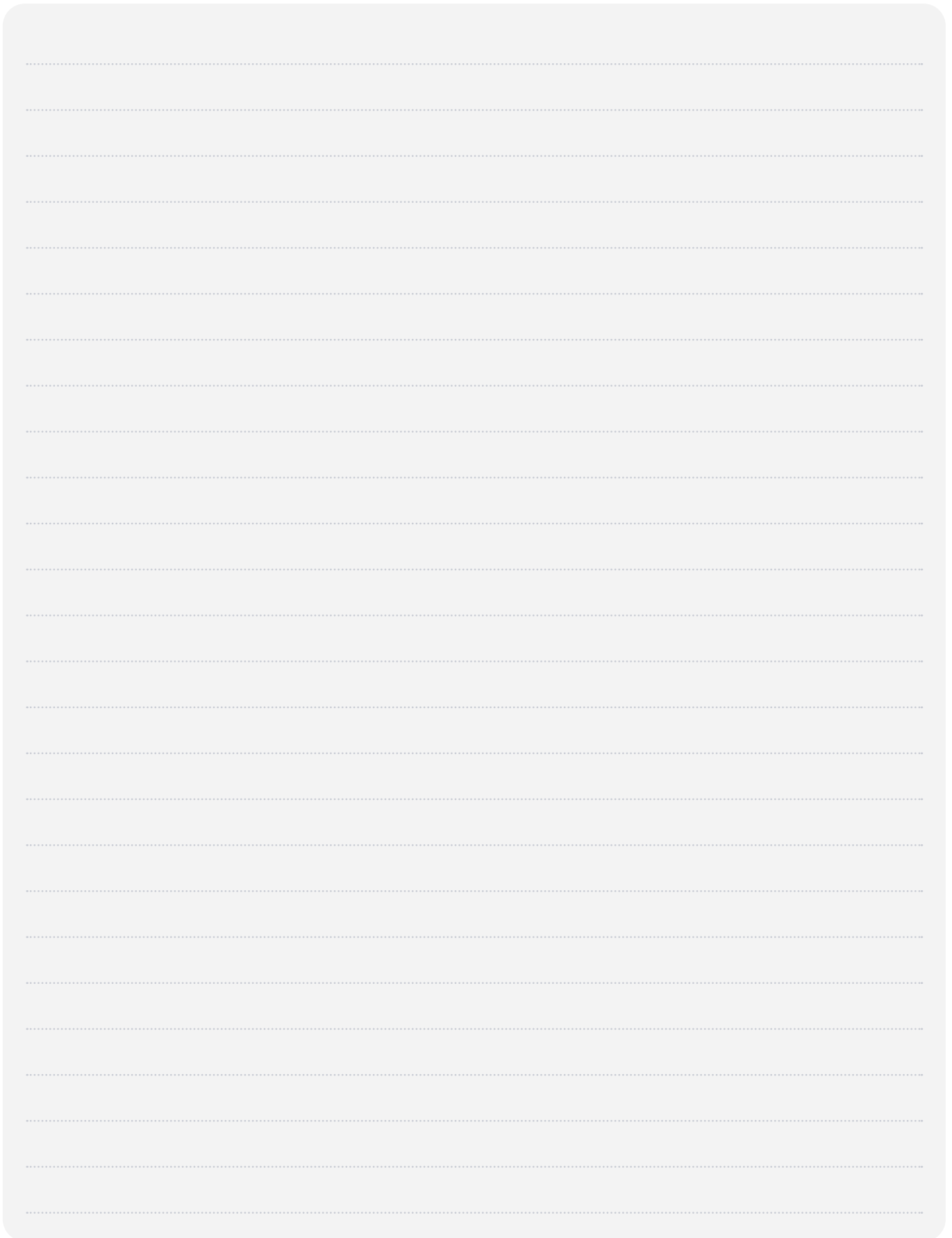

A large, light gray rounded rectangle containing horizontal dotted lines for writing notes. The lines are evenly spaced and extend across the width of the rectangle, providing a template for handwritten text.

## NOTES

A large, light gray rectangular area with rounded corners, containing numerous horizontal dotted lines for writing notes.

## NOTES

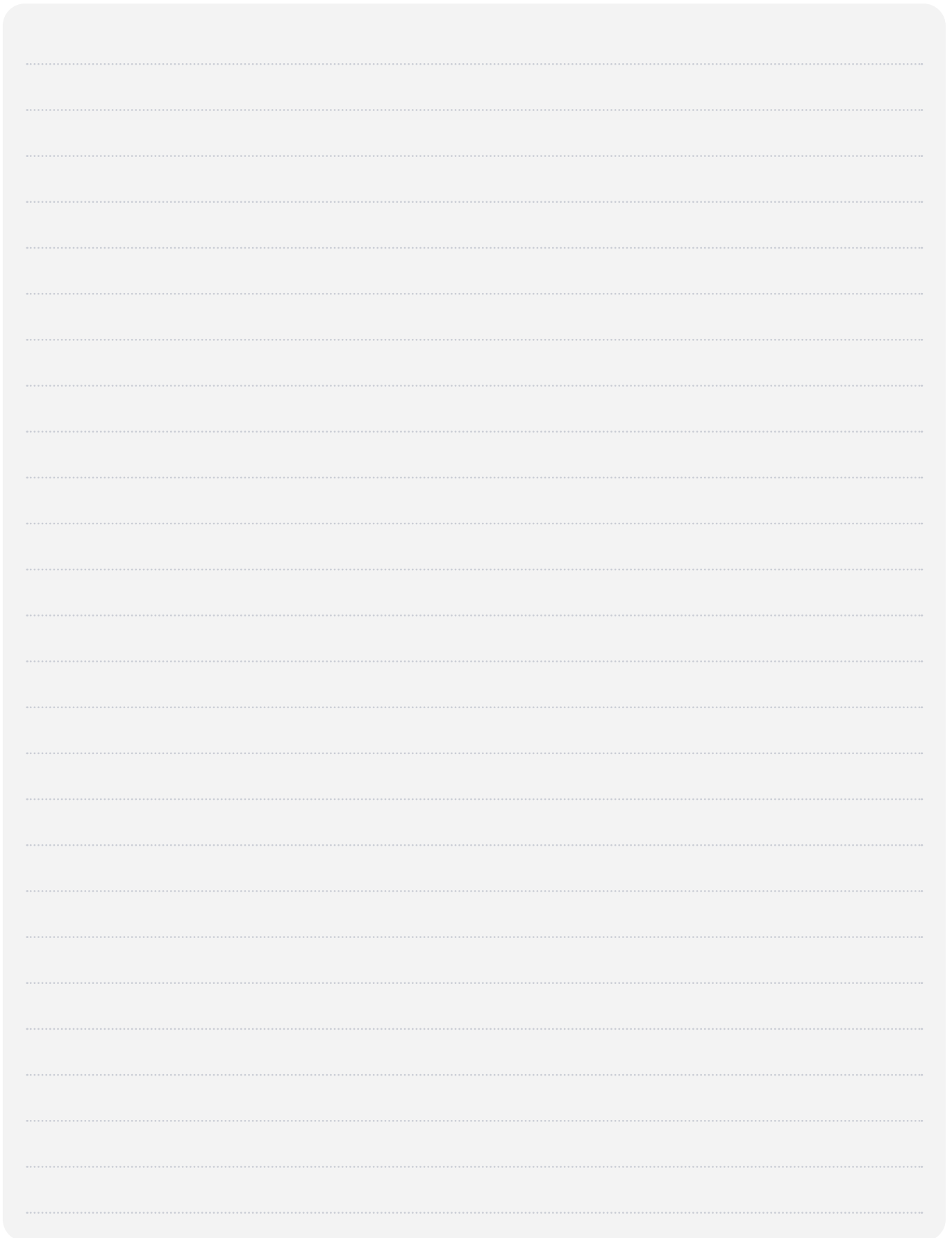

A large, light gray rounded rectangle containing numerous horizontal dotted lines for writing notes.

## NOTES

A large, light gray rectangular area with rounded corners, containing numerous horizontal dotted lines for writing notes.

## NOTES

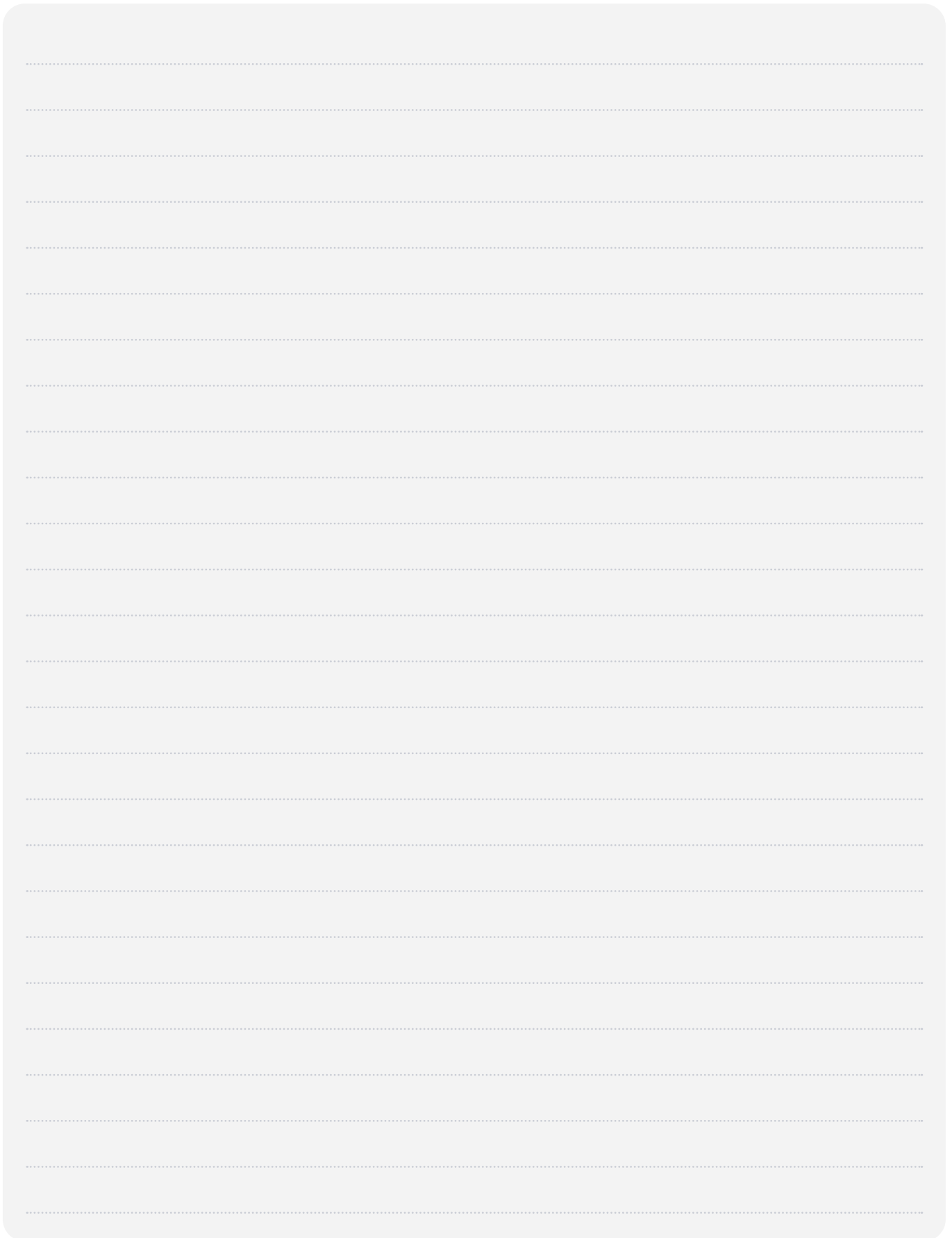



## NOTES

A large, light gray rounded rectangle containing horizontal dotted lines for writing notes. The lines are evenly spaced and extend across the width of the rectangle.

## NOTES

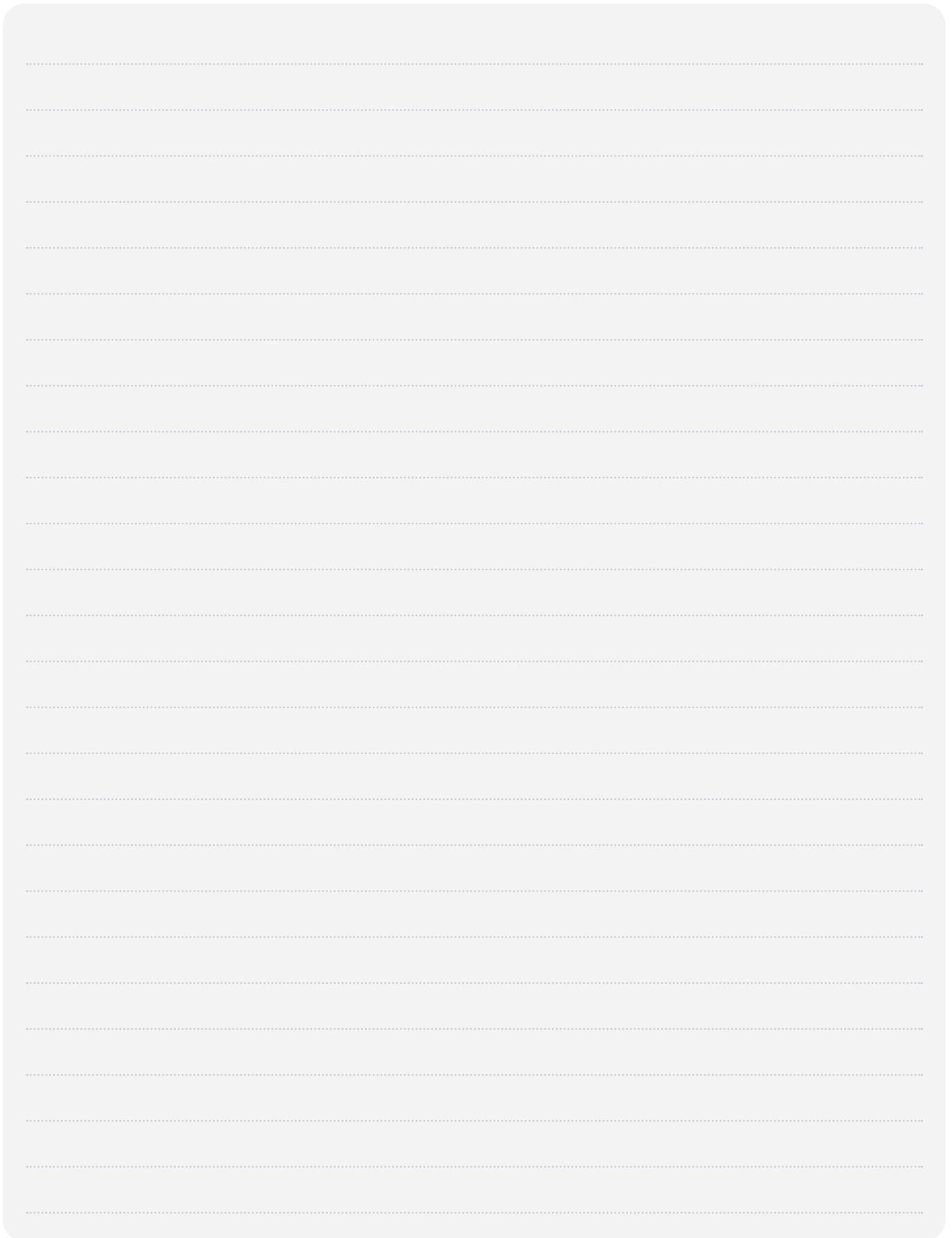

A large, light gray rounded rectangle containing horizontal dotted lines for writing notes. The lines are evenly spaced and extend across the width of the rectangle, providing a template for handwritten text.

## NOTES

A large, light gray rectangular area with rounded corners, containing numerous horizontal dotted lines for writing notes.

# CONDITIONS GÉNÉRALES

**Toute commande entraîne de plein droit l'adhésion de l'acheteur aux présentes conditions générales nonobstant toute stipulation contraire des conditions générales de nos clients.**

## I - COMMANDES

Toutes les commandes doivent être adressées par écrit ou par télécopie. Nous nous réservons le droit d'apporter sans préavis toutes modifications à nos matériels sans avoir à modifier pareillement les appareils livrés ou à livrer.

Compte tenu des impératifs de fabrication, nous pourrions, pour les commandes de lampes de types spéciaux, livrer en plus ou en moins 10 % du nombre de lampes commandées.

## II - OFFRES

Le délai de validité de nos offres est de deux mois. Nos fournitures sont limitées aux matériels désignés dans le devis. Les prix de nos propositions sont révisables en fonction des formules mentionnées dans notre proposition.

## III - FACTURATION

Nos factures sont établies aux prix en vigueur à la date de livraison, compte tenu, pour les lampes de types spéciaux, des majorations de prix indiquées dans nos barèmes.

## IV - DELAIS

Les livraisons sont faites au fur et à mesure de nos possibilités. En cas d'impossibilité de fournir tel ou tel matériel, comme de livrer dans le délai convenu, il ne pourra être réclamé de dommages et intérêts.

## V - LIVRAISONS

Une participation forfaitaire aux frais de transport et d'emballage de nos lampes et matériels est facturée. Cette participation est fixée à 25 € net HT. Toutefois, nos expéditions bénéficieront du franco de port et d'emballage pour toute commande unitaire à livrer en une seule fois en Métropole d'une valeur de 500 € net HT. Commande minimum : 75 € HT. Pour les commandes inférieures : frais fixe de 20 € HT. Nos marchandises voyagent aux risques et périls de l'acheteur, même en cas de retour ou d'envoi effectué franco de port et contre remboursement. Il appartient à l'acheteur de faire toutes les réserves nécessaires et d'exercer tous recours éventuels contre les transporteurs en cas d'avaries ou de manquants.

## VI - RETOUR

Aucun retour de matériel ne pourra être effectué sans notre accord écrit préalable. Le matériel, dont le retour aura été accepté, devra être réexpédié dans son emballage d'origine en parfait état franco de port et à l'adresse indiquée.

## VII - PAIEMENTS

Le paiement de nos factures s'effectue :

- soit au comptant avec un escompte (le montant est le même que pour le paiement anticipé et est indiqué sur chaque facture) ;
- soit sous réserve de références favorables 30 jours fin de mois date de facture, sans escompte.

La date d'échéance de délais de paiement est la date d'encaissement effectif de la créance. Elle est indiquée sur nos factures. On entend par paiement comptant celui faisant l'objet d'un encaissement effectif sous 20 jours maximum, date de facture.

## VIII - PAIEMENT ANTICIPÉ

Tout paiement anticipé donne droit à un escompte dont le taux est de 1/12 du taux de base bancaire par période de 30 jours. Il est indiqué sur toutes nos factures.

## IX - PÉNALITÉS DE RETARD

En application de la loi 92-1442 du 31-12-1992, tout retard de paiement par rapport aux dates contractuelles donnera lieu de plein droit à une pénalité de retard calculée par application aux sommes restant dues, d'un taux d'intérêt égal à trois fois le taux d'intérêt légal sans que cette pénalité nuise à l'exigibilité de la dette. Le montant de la pénalité de retard sera exigible après mise en demeure de notre part. Un forfait de 40 € sera facturé en plus pour frais de gestion.

Les termes de paiement convenus ne peuvent être retardés sous quelque prétexte que ce soit, y compris en cas de litige.

## X - GARANTIE

Les appareils d'éclairage sont garantis selon la durée légale. La main-d'œuvre et les frais de transport éventuels sont toutefois à la charge du client. La garantie ne couvre pas les défauts qui proviendraient du non-respect des prescriptions d'utilisation, d'une cause étrangère au matériel (mauvaise installation électrique, surtension, foudre, etc...), ou de toutes modifications ou interventions du client ou d'un tiers, sans notre accord.

La date de prise en compte de la garantie est la date indiquée dans le document de cession entre le distributeur et son client (BL ou facture).

Aucune indemnité ne sera accordée pour privation de jouissance.

## XI - ATTRIBUTION DE COMPÉTENCE

En cas de contestation, le Tribunal de Commerce de Paris sera compétent. La création de traite n'entraîne pas une dérogation à cette clause attributive de juridiction.

## XII - RÉSERVE DE PROPRIÉTÉ

Le vendeur conserve la propriété des biens vendus jusqu'à paiement effectif de l'intégralité du prix en principal et accessoires.

Le défaut de paiement de l'une des échéances pourra entraîner la revendication de ces biens. L'acheteur assume néanmoins à compter de la livraison, les risques de perte ou de détérioration de ces biens ainsi que la responsabilité des dommages qu'ils pourraient occasionner.

## XIII - DÉCHETS ÉLECTRONIQUES

Les prix indiqués dans nos tarifs ne tiennent pas compte de l'éventuel impact économique de l'obligation faite par le décret n°2005-829 du 20 juillet 2005 aux producteurs d'équipements électriques et électroniques, d'assurer la collecte et l'élimination des déchets issus de ces équipements. Les prix de vente des équipements visés par le décret sus mentionné sont donc sujets à révision en cours d'année.

# LISTE DES CODES (0032 à 0790) - TARIFS 02/2020

| Code | Prix € HT 02/2020 | Prod. | U.E. | Page    |
|------|-------------------|-------|------|---------|
| 0032 | 103,90 €          | B     | 1    | 224/429 |
| 0033 | 217,50 €          | B     | 1    | 224/429 |
| 0034 | 120,20 €          | B     | 1    | 430/433 |
| 0035 | 130,70 €          | B     | 1    | 431/433 |
| 0046 | 28,60 €           | B     | 1    | 430     |
| 0052 | 40,80 €           | B     | 1    | 431     |
| 0055 | 37,70 €           | B     | 1    | 431     |
| 0058 | 135,50 €          | B     | 1    | 430/433 |
| 0059 | 146,00 €          | B     | 1    | 431/433 |
| 0097 | 10,20 €           | B     | 1    | 42      |
| 0098 | 10,20 €           | B     | 1    | 42      |
| 0099 | 18,40 €           | B     | 1    | 42      |
| 0103 | 2,00 €            | B     | 1    | 42/45   |
| 0106 | 26,50 €           | B     | 1    | HC      |
| 0112 | 78,30 €           | B     | 1    | 245     |
| 0113 | 78,30 €           | B     | 1    | 245     |
| 0114 | 78,30 €           | B     | 1    | 245     |
| 0115 | 8,20 €            | B     | 1    | HC      |
| 0117 | 18,60 €           | B     | 1    | HC      |
| 0120 | 13,60 €           | B     | 1    | 273     |
| 0121 | 21,60 €           | B     | 1    | 273     |
| 0122 | 9,10 €            | B     | 1    | 255     |
| 0127 | 34,70 €           | B     | 1    | 399     |
| 0131 | 18,40 €           | B     | 1    | HC      |
| 0133 | 6,20 €            | B     | 1    | HC      |
| 0134 | 8,20 €            | B     | 1    | 347     |
| 0135 | 8,20 €            | B     | 1    | 347     |
| 0146 | 8,80 €            | B     | 1    | HC      |
| 0160 | 2,00 €            | B     | 1    | HC      |
| 0161 | 2,00 €            | B     | 1    | HC      |
| 0162 | 9,20 €            | B     | 1    | HC      |
| 0163 | 12,20 €           | B     | 1    | HC      |
| 0167 | 9,20 €            | B     | 1    | HC      |
| 0168 | 12,20 €           | B     | 1    | HC      |
| 0169 | 2,00 €            | B     | 1    | 79      |
| 0171 | 0,03 €            | B     | 1    | HC      |
| 0173 | 0,04 €            | B     | 1    | HC      |
| 0196 | 19,00 €           | B     | 1    | 316     |
| 0197 | 19,00 €           | B     | 1    | 316     |
| 0221 | 39,20 €           | B     | 1    | 152     |
| 0222 | 55,30 €           | B     | 1    | 152     |
| 0234 | 1,10 €            | B     | 10   | 202     |
| 0238 | 44,20 €           | B     | 1    | 153     |
| 0248 | 39,80 €           | B     | 1    | 371     |
| 0249 | 63,70 €           | B     | 1    | 372/373 |
| 0250 | 16,70 €           | B     | 10   | 176     |
| 0251 | 19,10 €           | B     | 10   | 176     |
| 0252 | 28,90 €           | B     | 10   | 176     |
| 0255 | 49,10 €           | B     | 10   | 177     |
| 0257 | 138,10 €          | B     | 1    | 152     |
| 0258 | 45,00 €           | B     | 1    | 152     |
| 0260 | 50,20 €           | B     | 1    | 148     |
| 0261 | 50,20 €           | B     | 1    | 149     |
| 0268 | 64,00 €           | B     | 1    | 153     |
| 0269 | 52,50 €           | B     | 1    | 153     |
| 0280 | 6,80 €            | B     | 1    | 371     |
| 0284 | 157,70 €          | B     | 1    | 153     |
| 0298 | 10,30 €           | B     | 1    | 372/373 |
| 0300 | 80,00 €           | B     | 1    | 324     |
| 0312 | 79,60 €           | B     | 1    | 172     |
| 0313 | 82,60 €           | B     | 1    | 172     |
| 0316 | 6,80 €            | C     | 1    | HC      |
| 0321 | 14,80 €           | B     | 1    | HC      |
| 0324 | 49,70 €           | B     | 1    | 148     |
| 0325 | 49,70 €           | B     | 1    | 149     |
| 0326 | 217,30 €          | B     | 1    | 151     |
| 0327 | 307,00 €          | B     | 1    | 151     |
| 0329 | 83,90 €           | B     | 1    | 260     |
| 0334 | 275,80 €          | B     | 1    | HC      |
| 0335 | 319,90 €          | B     | 1    | HC      |
| 0340 | 171,70 €          | B     | 1    | 404     |

| Code | Prix € HT 02/2020 | Prod. | U.E. | Page    |
|------|-------------------|-------|------|---------|
| 0341 | 243,50 €          | B     | 1    | 404     |
| 0358 | 19,90 €           | B     | 1    | 184     |
| 0359 | 51,40 €           | B     | 1    | 407     |
| 0360 | 83,90 €           | B     | 1    | HC      |
| 0362 | 22,50 €           | B     | 1    | 184     |
| 0367 | 275,80 €          | B     | 1    | HC      |
| 0368 | 141,80 €          | B     | 1    | 260     |
| 0369 | 141,80 €          | B     | 1    | HC      |
| 0370 | 312,20 €          | B     | 1    | 404     |
| 0376 | 319,90 €          | B     | 1    | HC      |
| 0378 | 30,70 €           | B     | 1    | 163     |
| 0387 | 311,90 €          | B     | 1    | HC      |
| 0390 | 5,40 €            | B     | 1    | 378     |
| 0401 | 28,60 €           | B     | 4    | 183     |
| 0402 | 36,70 €           | B     | 4    | 183     |
| 0403 | 10,70 €           | B     | 1    | HC      |
| 0404 | 11,80 €           | B     | 1    | HC      |
| 0406 | 71,80 €           | B     | 1    | 154     |
| 0408 | 78,70 €           | B     | 1    | 155     |
| 0418 | 35,00 €           | B     | 10   | 179     |
| 0420 | 42,40 €           | B     | 4    | 179     |
| 0422 | 37,10 €           | B     | 10   | HC      |
| 0423 | 40,30 €           | B     | 4    | HC      |
| 0425 | 44,60 €           | B     | 4    | HC      |
| 0428 | 50,80 €           | B     | 1    | 150     |
| 0429 | 78,50 €           | B     | 1    | 150     |
| 0433 | 179,60 €          | B     | 1    | 413     |
| 0435 | 212,70 €          | B     | 1    | 413     |
| 0441 | 87,70 €           | B     | 1    | 150     |
| 0442 | 125,50 €          | B     | 1    | 150     |
| 0448 | 58,90 €           | B     | 1    | 400/403 |
| 0451 | 38,30 €           | B     | 1    | 149     |
| 0455 | 30,60 €           | B     | 1    | 444     |
| 0459 | 48,70 €           | B     | 1    | 287     |
| 0460 | 50,40 €           | B     | 12   | HC      |
| 0462 | 43,50 €           | B     | 4    | HC      |
| 0466 | 47,70 €           | B     | 4    | HC      |
| 0468 | 48,30 €           | B     | 1    | HC      |
| 0474 | 18,90 €           | B     | 10   | HC      |
| 0475 | 17,20 €           | B     | 10   | HC      |
| 0481 | 78,00 €           | B     | 1    | 287     |
| 0482 | 88,80 €           | B     | 1    | 287     |
| 0491 | 17,10 €           | B     | 10   | HC      |
| 0492 | 18,20 €           | B     | 10   | HC      |
| 0494 | 18,30 €           | B     | 10   | HC      |
| 0495 | 19,30 €           | B     | 10   | HC      |
| 0497 | 17,10 €           | B     | 10   | HC      |
| 0498 | 18,30 €           | B     | 10   | HC      |
| 0500 | NC                | B     | 1    | 444/444 |
| 0508 | 50,50 €           | B     | 1    | 366     |
| 0509 | 50,50 €           | B     | 1    | 366     |
| 0512 | 20,00 €           | B     | 10   | HC      |
| 0513 | 21,10 €           | B     | 10   | HC      |
| 0514 | 50,00 €           | B     | 1    | 366     |
| 0515 | 50,00 €           | B     | 1    | 366     |
| 0519 | NC                | B     | 1    | 444     |
| 0522 | 29,90 €           | B     | 1    | 444     |
| 0525 | 42,80 €           | B     | 1    | 367     |
| 0526 | 42,80 €           | B     | 1    | 367     |
| 0527 | 55,10 €           | B     | 1    | 367     |
| 0531 | 1,50 €            | B     | 1    | 445     |
| 0532 | 1,20 €            | B     | 1    | 445     |
| 0533 | NC                | B     | 1    | 444     |
| 0540 | 30,60 €           | B     | 1    | 121     |
| 0556 | 12,20 €           | B     | 1    | HC      |
| 0557 | 18,40 €           | B     | 1    | HC      |
| 0559 | 67,70 €           | B     | 6    | HC      |
| 0560 | 30,60 €           | B     | 1    | 121     |
| 0561 | 67,70 €           | B     | 6    | HC      |
| 0563 | 24,00 €           | B     | 12   | 321     |
| 0564 | NC                | B     | 1    | 444     |

| Code | Prix € HT 02/2020 | Prod. | U.E. | Page      |
|------|-------------------|-------|------|-----------|
| 0573 | 24,00 €           | B     | 12   | HC        |
| 0574 | 18,20 €           | B     | 1    | 321       |
| 0575 | 58,90 €           | B     | 1    | 394 & 402 |
| 0576 | 18,20 €           | B     | 1    | 321       |
| 0578 | 121,10 €          | B     | 1    | 154       |
| 0579 | 175,40 €          | B     | 1    | 154       |
| 0585 | 15,20 €           | B     | 10   | HC        |
| 0586 | 47,50 €           | B     | 6    | HC        |
| 0589 | 8,30 €            | B     | 1    | 190       |
| 0592 | 111,70 €          | B     | 6    | 320       |
| 0593 | 128,80 €          | B     | 6    | 320       |
| 0599 | 0,10 €            | B     | 1    | 225       |
| 0600 | 26,50 €           | B     | 1    | 161       |
| 0601 | 26,50 €           | B     | 1    | 161       |
| 0607 | 28,70 €           | B     | 1    | 109/430   |
| 0611 | 15,70 €           | B     | 1    | HC        |
| 0612 | 12,10 €           | B     | 1    | 108       |
| 0617 | 28,70 €           | B     | 1    | 162       |
| 0624 | 23,70 €           | B     | 1    | 190       |
| 0632 | 37,70 €           | B     | 1    | 224/428   |
| 0636 | 37,70 €           | B     | 1    | 427       |
| 0638 | 31,80 €           | B     | 1    | 431       |
| 0642 | 10,90 €           | B     | 1    | 435       |
| 0643 | 57,00 €           | B     | 1    | HC        |
| 0649 | 30,60 €           | B     | 1    | 435       |
| 0650 | 50,00 €           | B     | 1    | 427       |
| 0651 | 10,80 €           | B     | 10   | 178       |
| 0652 | 13,30 €           | B     | 10   | 178       |
| 0653 | 18,10 €           | B     | 10   | 178       |
| 0668 | 87,60 €           | B     | 1    | HC        |
| 0669 | 29,10 €           | B     | 4    | 160       |
| 0670 | 29,10 €           | B     | 4    | 160       |
| 0671 | 59,90 €           | B     | 1    | HC        |
| 0673 | 35,30 €           | B     | 4    | 160       |
| 0674 | 92,40 €           | B     | 1    | HC        |
| 0675 | 70,40 €           | B     | 1    | 428/432   |
| 0676 | 62,60 €           | B     | 4    | 160       |
| 0679 | 84,80 €           | B     | 4    | 160       |
| 0680 | 68,40 €           | B     | 1    | 426       |
| 0685 | 145,90 €          | B     | 1    | 428/432   |
| 0688 | 31,70 €           | B     | 1    | 161       |
| 0690 | 68,40 €           | B     | 1    | 426       |
| 0691 | 40,00 €           | B     | 1    | 161       |
| 0692 | 40,00 €           | B     | 1    | 161       |
| 0693 | 26,20 €           | B     | 1    | 427       |
| 0694 | 69,70 €           | B     | 1    | 161       |
| 0695 | 52,60 €           | B     | 1    | 429       |
| 0696 | 100,30 €          | B     | 1    | 161       |
| 0697 | 25,10 €           | B     | 1    | 428       |
| 0700 | 135,00 €          | B     | 1    | 426       |
| 0702 | 8,70 €            | A     | 10   | 35        |
| 0708 | 73,40 €           | B     | 1    | HC        |
| 0727 | 9,50 €            | B     | 1    | HC        |
| 0728 | 31,80 €           | B     | 1    | 430       |
| 0732 | 215,20 €          | B     | 1    | 224/428   |
| 0739 | 31,40 €           | B     | 1    | 442       |
| 0743 | 13,80 €           | B     | 1    | 442       |
| 0744 | 75,50 €           | B     | 1    | 427       |
| 0752 | 77,20 €           | B     | 1    | 231       |
| 0753 | 77,20 €           | B     | 1    | 231       |
| 0759 | 11,80 €           | B     | 1    | HC        |
| 0764 | 11,60 €           | B     | 1    | HC        |
| 0770 | 143,40 €          | B     | 1    | 231       |
| 0771 | 143,40 €          | B     | 1    | 231       |
| 0774 | 105,10 €          | B     | 1    | 157       |
| 0780 | 19,30 €           | B     | 1    | 365       |
| 0784 | 88,70 €           | B     | 1    | 157       |
| 0785 | 134,60 €          | B     | 1    | 156       |
| 0786 | 197,90 €          | B     | 1    | 156       |
| 0789 | 50,40 €           | B     | 1    | 435       |
| 0790 | 40,90 €           | B     | 10   | 322       |

Ces prix sont valables en France métropolitaine et Dom-Tom.

# LISTE DES CODES (0797 à 1513) - TARIFS 02/2020

| Code | Prix € HT 02/2020 | Prod. | U.E. | Page    |
|------|-------------------|-------|------|---------|
| 0797 | 195,00 €          | B     | 1    | 397     |
| 0799 | 2,70 €            | C     | 10   | 445     |
| 0801 | 71,20 €           | B     | 1    | 325     |
| 0802 | 71,20 €           | B     | 1    | 325     |
| 0803 | 185,50 €          | B     | 1    | 413     |
| 0804 | 93,30 €           | B     | 1    | 413     |
| 0805 | 3,60 €            | C     | 10   | 445     |
| 0809 | 3,60 €            | C     | 10   | 445     |
| 0811 | 77,20 €           | B     | 1    | 231     |
| 0812 | 15,40 €           | B     | 1    | 410     |
| 0817 | 143,40 €          | B     | 1    | 231     |
| 0818 | 15,40 €           | B     | 1    | 410     |
| 0820 | 10,10 €           | B     | 1    | 431     |
| 0821 | 17,50 €           | B     | 1    | 431     |
| 0825 | 58,60 €           | B     | 1    | HC      |
| 0826 | 9,50 €            | B     | 1    | HC      |
| 0827 | 96,90 €           | B     | 1    | 413     |
| 0830 | 7,80 €            | B     | 5    | 445     |
| 0831 | 2,30 €            | B     | 10   | HC      |
| 0832 | 0,40 €            | B     | 10   | 227     |
| 0836 | 5,10 €            | B     | 1    | 322     |
| 0845 | 2,30 €            | C     | 1    | 445     |
| 0848 | 4,70 €            | B     | 2    | 190/222 |
| 0850 | 2,90 €            | A     | 25   | 37      |
| 0853 | 2,50 €            | A     | 25   | 37      |
| 0854 | 2,40 €            | A     | 25   | 37      |
| 0855 | 3,20 €            | A     | 25   | 37      |
| 0857 | 9,40 €            | B     | 2    | 190/222 |
| 0859 | 23,10 €           | B     | 1    | HC      |
| 0866 | 26,20 €           | B     | 1    | 435/445 |
| 0870 | 41,20 €           | C     | 1    | 445     |
| 0878 | 30,50 €           | B     | 1    | HC      |
| 0879 | 30,50 €           | B     | 1    | HC      |
| 0880 | 50,60 €           | B     | 1    | HC      |
| 0881 | 21,40 €           | B     | 1    | 114/191 |
| 0884 | 101,70 €          | B     | 1    | 435     |
| 0885 | 130,90 €          | B     | 1    | 435     |
| 0886 | 160,60 €          | B     | 1    | 435     |
| 0887 | 30,50 €           | B     | 1    | HC      |
| 0888 | 64,90 €           | B     | 1    | 436     |
| 0889 | 198,80 €          | B     | 1    | 436     |
| 0896 | 21,80 €           | B     | 1    | HC      |
| 0897 | 21,80 €           | B     | 1    | HC      |
| 0898 | 16,20 €           | B     | 1    | HC      |
| 0899 | 16,20 €           | B     | 1    | HC      |
| 0901 | 11,20 €           | B     | 1    | HC      |
| 0905 | 12,40 €           | B     | 1    | HC      |
| 0906 | 9,80 €            | B     | 1    | HC      |
| 0907 | 32,30 €           | B     | 1    | HC      |
| 0908 | 32,30 €           | B     | 1    | HC      |
| 0909 | 0,10 €            | B     | 1    | 203/205 |
| 0917 | 8,00 €            | B     | 1    | HC      |
| 0920 | 10,20 €           | B     | 1    | 176     |
| 0922 | 26,00 €           | B     | 1    | 410     |
| 0923 | 26,00 €           | B     | 1    | 410     |
| 0924 | 8,70 €            | B     | 1    | HC      |
| 0925 | 0,60 €            | B     | 2    | HC      |
| 0927 | 0,60 €            | B     | 2    | HC      |
| 0929 | 7,10 €            | B     | 1    | HC      |
| 0935 | 2,70 €            | B     | 1    | 117     |
| 0938 | 68,10 €           | B     | 1    | 383     |
| 0939 | 13,60 €           | B     | 1    | 383     |
| 0940 | 33,30 €           | B     | 1    | 227     |
| 0941 | 75,30 €           | B     | 1    | 319     |
| 0942 | 15,70 €           | B     | 1    | 227     |
| 0945 | 0,10 €            | B     | 1    | 227     |
| 0946 | 0,04 €            | B     | 1    | 203/227 |
| 0948 | 19,90 €           | B     | 6    | HC      |
| 0952 | 55,70 €           | B     | 1    | 416     |
| 0953 | 37,50 €           | B     | 1    | HC      |
| 0971 | 75,30 €           | B     | 1    | 319     |

| Code | Prix € HT 02/2020 | Prod. | U.E. | Page    |
|------|-------------------|-------|------|---------|
| 0980 | 15,40 €           | B     | 1    | HC      |
| 0984 | 35,60 €           | B     | 1    | 111/430 |
| 0988 | 3,50 €            | B     | 1    | 114     |
| 0989 | 4,70 €            | B     | 1    | 114     |
| 0992 | 8,00 €            | B     | 1    | 188     |
| 0998 | 35,30 €           | B     | 1    | HC      |
| 1022 | 33,10 €           | B     | 1    | 222     |
| 1025 | 1,10 €            | B     | 1    | 203     |
| 1040 | 1,10 €            | B     | 1    | 203     |
| 1041 | 19,30 €           | B     | 1    | 222     |
| 1048 | 0,50 €            | B     | 1    | HC      |
| 1050 | 0,60 €            | B     | 1    | HC      |
| 1051 | 6,40 €            | B     | 1    | 252     |
| 1052 | 7,20 €            | B     | 1    | 253     |
| 1053 | 1,40 €            | B     | 1    | 203     |
| 1054 | 21,00 €           | B     | 1    | HC      |
| 1055 | 21,00 €           | B     | 1    | HC      |
| 1056 | 35,20 €           | B     | 1    | HC      |
| 1057 | 0,50 €            | B     | 1    | HC      |
| 1058 | 0,50 €            | B     | 1    | HC      |
| 1059 | 0,60 €            | B     | 1    | 227     |
| 1062 | 31,50 €           | B     | 4    | 191     |
| 1063 | 40,90 €           | B     | 4    | 191     |
| 1079 | 10,90 €           | B     | 1    | 357     |
| 1083 | 34,50 €           | B     | 1    | HC      |
| 1098 | 16,30 €           | B     | 1    | 257     |
| 1101 | 68,40 €           | B     | 4    | HC      |
| 1105 | 5,00 €            | B     | 1    | HC      |
| 1106 | 5,00 €            | B     | 1    | HC      |
| 1107 | 68,40 €           | B     | 4    | HC      |
| 1110 | 12,20 €           | B     | 1    | 188     |
| 1120 | 21,40 €           | B     | 10   | 174     |
| 1121 | 24,30 €           | B     | 10   | 174     |
| 1122 | 29,90 €           | B     | 10   | 174     |
| 1124 | 51,10 €           | B     | 10   | 174     |
| 1125 | 82,60 €           | B     | 4    | 156     |
| 1126 | 101,00 €          | B     | 4    | 156     |
| 1127 | 11,60 €           | B     | 1    | 408/409 |
| 1146 | 5,20 €            | B     | 1    | 149     |
| 1155 | 4,20 €            | B     | 1    | HC      |
| 1156 | 7,00 €            | B     | 1    | HC      |
| 1157 | 7,00 €            | B     | 1    | HC      |
| 1169 | 75,30 €           | B     | 2    | 319     |
| 1173 | 2,50 €            | B     | 1    | 409     |
| 1176 | 203,20 €          | B     | 1    | 149     |
| 1191 | 75,30 €           | B     | 2    | 319     |
| 1195 | 50,80 €           | B     | 1    | HC      |
| 1196 | 75,30 €           | B     | 2    | 319     |
| 1197 | 304,90 €          | B     | 1    | 149     |
| 1207 | 18,00 €           | B     | 1    | 365     |
| 1214 | 36,90 €           | B     | 1    | 444     |
| 1215 | 13,30 €           | B     | 1    | 444     |
| 1216 | 14,10 €           | B     | 1    | 383     |
| 1222 | 105,00 €          | B     | 1    | 445     |
| 1223 | 26,10 €           | B     | 1    | 120     |
| 1225 | 12,40 €           | B     | 1    | HC      |
| 1226 | 10,80 €           | B     | 1    | 174     |
| 1229 | 17,30 €           | B     | 1    | 382     |
| 1242 | 8,40 €            | B     | 1    | HC      |
| 1251 | 17,40 €           | B     | 1    | HC      |
| 1254 | 17,40 €           | B     | 10   | HC      |
| 1257 | 5,60 €            | B     | 1    | 445     |
| 1271 | 43,70 €           | B     | 1    | 282/283 |
| 1273 | 77,30 €           | B     | 1    | 282     |
| 1274 | 38,80 €           | B     | 1    | 444     |
| 1276 | 88,80 €           | B     | 1    | 155     |
| 1277 | 61,20 €           | B     | 1    | 151     |
| 1278 | 66,30 €           | B     | 1    | 151     |
| 1283 | 65,90 €           | B     | 1    | HC      |
| 1284 | 34,90 €           | B     | 10   | HC      |
| 1285 | 37,70 €           | B     | 10   | HC      |

| Code | Prix € HT 02/2020 | Prod. | U.E. | Page |
|------|-------------------|-------|------|------|
| 1287 | 9,80 €            | B     | 1    | HC   |
| 1288 | 9,80 €            | B     | 1    | HC   |
| 1289 | 90,80 €           | B     | 1    | 157  |
| 1290 | 44,40 €           | B     | 1    | 162  |
| 1298 | 80,60 €           | B     | 1    | HC   |
| 1299 | 83,60 €           | B     | 1    | HC   |
| 1300 | 38,30 €           | B     | 1    | 148  |
| 1309 | 85,90 €           | B     | 2    | 319  |
| 1315 | 53,50 €           | B     | 1    | 271  |
| 1316 | 90,10 €           | B     | 1    | 271  |
| 1319 | 84,50 €           | B     | 1    | 271  |
| 1322 | 119,70 €          | B     | 1    | HC   |
| 1328 | 11,90 €           | B     | 1    | 445  |
| 1333 | 39,70 €           | B     | 1    | HC   |
| 1337 | 18,40 €           | C     | 1    | HC   |
| 1339 | 55,50 €           | B     | 1    | HC   |
| 1341 | 6,70 €            | B     | 1    | HC   |
| 1343 | 48,00 €           | B     | 1    | 222  |
| 1345 | 54,40 €           | B     | 1    | 254  |
| 1348 | 45,40 €           | B     | 1    | 271  |
| 1351 | 27,20 €           | B     | 1    | HC   |
| 1352 | 30,70 €           | B     | 1    | HC   |
| 1353 | 41,40 €           | B     | 1    | HC   |
| 1354 | 50,80 €           | B     | 1    | HC   |
| 1361 | 9,90 €            | B     | 6    | HC   |
| 1366 | 4,50 €            | B     | 1    | HC   |
| 1367 | 6,60 €            | B     | 1    | HC   |
| 1368 | 1,90 €            | B     | 1    | HC   |
| 1369 | 2,30 €            | B     | 1    | HC   |
| 1370 | 9,90 €            | B     | 6    | HC   |
| 1372 | 15,70 €           | B     | 1    | HC   |
| 1373 | 38,30 €           | B     | 1    | 148  |
| 1380 | 9,90 €            | B     | 6    | HC   |
| 1381 | 38,30 €           | B     | 1    | 149  |
| 1387 | 44,90 €           | B     | 1    | 254  |
| 1388 | 70,90 €           | B     | 1    | 254  |
| 1390 | 10,80 €           | B     | 1    | 117  |
| 1392 | 12,10 €           | B     | 1    | 117  |
| 1393 | 8,70 €            | B     | 1    | 117  |
| 1395 | 13,20 €           | B     | 1    | 117  |
| 1397 | 2,30 €            | B     | 1    | 430  |
| 1398 | 2,30 €            | B     | 1    | 431  |
| 1400 | 15,80 €           | B     | 1    | HC   |
| 1402 | 28,10 €           | B     | 1    | HC   |
| 1405 | 15,80 €           | B     | 1    | HC   |
| 1410 | 28,30 €           | B     | 1    | HC   |
| 1413 | 28,30 €           | B     | 1    | HC   |
| 1420 | 49,90 €           | B     | 1    | HC   |
| 1421 | 49,90 €           | B     | 1    | HC   |
| 1425 | 59,80 €           | B     | 1    | HC   |
| 1431 | 36,30 €           | B     | 1    | HC   |
| 1432 | 43,50 €           | B     | 1    | HC   |
| 1435 | 38,40 €           | B     | 1    | HC   |
| 1438 | 48,50 €           | B     | 1    | HC   |
| 1439 | 59,30 €           | B     | 1    | HC   |
| 1449 | 77,70 €           | B     | 1    | HC   |
| 1473 | 41,40 €           | B     | 1    | HC   |
| 1475 | 86,70 €           | B     | 1    | HC   |
| 1485 | 112,80 €          | B     | 1    | 437  |
| 1486 | 112,80 €          | B     | 1    | 437  |
| 1502 | 2,60 €            | B     | 1    | 445  |
| 1503 | 2,60 €            | B     | 1    | 445  |
| 1504 | 2,40 €            | B     | 1    | 445  |
| 1506 | 29,20 €           | B     | 1    | HC   |
| 1507 | 6,90 €            | B     | 1    | HC   |
| 1508 | 5,20 €            | B     | 1    | HC   |
| 1509 | 58,50 €           | B     | 1    | HC   |
| 1510 | 30,50 €           | B     | 1    | HC   |
| 1511 | 30,50 €           | B     | 1    | HC   |
| 1512 | 61,10 €           | B     | 1    | HC   |
| 1513 | 61,10 €           | B     | 1    | HC   |

Ces prix sont valables en France métropolitaine et Dom-Tom.

NC : nous consulter - HC : hors catalogue

# LISTE DES CODES (1514 à 2061) - TARIFS 02/2020

| Code | Prix € HT 02/2020 | Prod. | U.E. | Page    |
|------|-------------------|-------|------|---------|
| 1514 | 96,90 €           | B     | 1    | HC      |
| 1515 | 96,90 €           | B     | 1    | HC      |
| 1516 | 9,00 €            | B     | 10   | HC      |
| 1517 | 9,00 €            | B     | 10   | HC      |
| 1518 | 3,00 €            | B     | 1    | HC      |
| 1519 | 3,00 €            | B     | 1    | HC      |
| 1520 | 0,70 €            | B     | 10   | HC      |
| 1521 | 0,70 €            | B     | 10   | HC      |
| 1522 | 6,70 €            | B     | 10   | HC      |
| 1523 | 6,70 €            | B     | 10   | HC      |
| 1524 | 4,40 €            | B     | 1    | HC      |
| 1525 | 4,40 €            | B     | 1    | HC      |
| 1526 | 5,40 €            | B     | 10   | HC      |
| 1527 | 5,40 €            | B     | 10   | HC      |
| 1528 | 15,40 €           | B     | 5    | HC      |
| 1529 | 15,40 €           | B     | 5    | HC      |
| 1530 | 7,30 €            | B     | 10   | HC      |
| 1531 | 7,30 €            | B     | 10   | HC      |
| 1532 | 18,70 €           | B     | 5    | HC      |
| 1533 | 18,70 €           | B     | 5    | HC      |
| 1534 | 28,40 €           | B     | 4    | HC      |
| 1535 | 28,40 €           | B     | 4    | HC      |
| 1536 | 172,80 €          | B     | 1    | 437     |
| 1537 | 172,80 €          | B     | 1    | 437     |
| 1541 | 6,90 €            | B     | 1    | HC      |
| 1545 | 126,90 €          | B     | 1    | HC      |
| 1548 | 3,50 €            | B     | 5    | HC      |
| 1549 | 3,50 €            | B     | 5    | HC      |
| 1552 | 15,30 €           | B     | 10   | 437     |
| 1553 | 15,30 €           | B     | 10   | 437     |
| 1557 | 15,30 €           | B     | 1    | HC      |
| 1560 | 121,60 €          | B     | 1    | 437     |
| 1561 | 121,60 €          | B     | 1    | 437     |
| 1564 | 16,90 €           | B     | 1    | 437     |
| 1565 | 16,90 €           | B     | 1    | 437     |
| 1581 | 122,50 €          | B     | 1    | HC      |
| 1586 | 31,50 €           | B     | 1    | HC      |
| 1587 | 37,00 €           | B     | 1    | HC      |
| 1604 | 16,30 €           | B     | 1    | 125/439 |
| 1605 | 16,30 €           | B     | 1    | 125/439 |
| 1606 | 16,30 €           | B     | 1    | 125/439 |
| 1613 | 36,30 €           | B     | 1    | 125/439 |
| 1614 | 72,60 €           | B     | 1    | 125/439 |
| 1615 | 12,90 €           | B     | 1    | 125/439 |
| 1616 | 32,20 €           | B     | 1    | 125/439 |
| 1617 | 8,90 €            | B     | 1    | 125/439 |
| 1618 | 51,70 €           | B     | 1    | 125/439 |
| 1619 | 19,40 €           | B     | 1    | 125/439 |
| 1620 | 3,20 €            | B     | 1    | 125/439 |
| 1629 | 36,70 €           | B     | 1    | HC      |
| 1631 | 36,30 €           | B     | 1    | 125/439 |
| 1632 | 72,60 €           | B     | 1    | 125/439 |
| 1633 | 19,40 €           | B     | 1    | 125/439 |
| 1634 | 42,70 €           | B     | 1    | 286     |
| 1635 | 48,80 €           | B     | 1    | 286     |
| 1636 | 29,80 €           | B     | 1    | 310/311 |
| 1637 | 29,80 €           | B     | 1    | 310/311 |
| 1638 | 131,80 €          | B     | 1    | 290     |
| 1639 | 234,40 €          | B     | 1    | HC      |
| 1642 | 255,60 €          | B     | 1    | HC      |
| 1645 | 36,30 €           | B     | 1    | 125/439 |
| 1646 | 72,60 €           | B     | 1    | 125/439 |
| 1647 | 12,90 €           | B     | 1    | 125/439 |
| 1648 | 12,90 €           | B     | 1    | 125/439 |
| 1649 | 32,20 €           | B     | 1    | 125/439 |
| 1650 | 8,90 €            | B     | 1    | 125/439 |
| 1651 | 51,70 €           | B     | 1    | 125/439 |
| 1652 | 43,60 €           | B     | 1    | 125/439 |
| 1653 | 59,40 €           | B     | 1    | 125/439 |
| 1654 | 59,40 €           | B     | 1    | 125/439 |
| 1655 | 77,40 €           | B     | 1    | 125/439 |

| Code | Prix € HT 02/2020 | Prod. | U.E. | Page    |
|------|-------------------|-------|------|---------|
| 1656 | 19,40 €           | B     | 1    | 125/439 |
| 1657 | 3,20 €            | B     | 1    | 125/439 |
| 1658 | 29,10 €           | B     | 1    | 125/439 |
| 1659 | 162,80 €          | B     | 1    | 290     |
| 1660 | 4,10 €            | B     | 1    | 125/439 |
| 1661 | 2,40 €            | B     | 1    | HC      |
| 1664 | 32,70 €           | B     | 1    | HC      |
| 1665 | 43,50 €           | B     | 1    | 320     |
| 1666 | 65,50 €           | B     | 1    | 320     |
| 1668 | 19,10 €           | B     | 1    | 320     |
| 1669 | 22,90 €           | B     | 1    | 320     |
| 1670 | 11,30 €           | B     | 1    | HC      |
| 1673 | 13,90 €           | B     | 1    | HC      |
| 1674 | 14,50 €           | B     | 1    | HC      |
| 1675 | 452,30 €          | B     | 1    | 400     |
| 1683 | 39,20 €           | B     | 1    | 444     |
| 1684 | 23,70 €           | B     | 1    | HC      |
| 1691 | 372,90 €          | B     | 1    | 403     |
| 1692 | 200,90 €          | B     | 1    | 352/402 |
| 1699 | 15,30 €           | B     | 1    | HC      |
| 1700 | 119,50 €          | B     | 1    | 383     |
| 1704 | 44,40 €           | B     | 1    | 353/411 |
| 1706 | 230,50 €          | B     | 1    | 402     |
| 1707 | 31,10 €           | B     | 1    | 353/410 |
| 1708 | 44,40 €           | B     | 1    | 353/411 |
| 1709 | 219,80 €          | B     | 1    | 402     |
| 1710 | 74,30 €           | B     | 1    | 411     |
| 1713 | 26,10 €           | B     | 1    | 120     |
| 1714 | 40,80 €           | B     | 1    | 120     |
| 1716 | 40,20 €           | B     | 1    | 411     |
| 1717 | 40,20 €           | B     | 1    | 411     |
| 1718 | 81,60 €           | B     | 1    | 411     |
| 1719 | 31,10 €           | B     | 1    | 353/410 |
| 1720 | 299,20 €          | B     | 1    | 383     |
| 1722 | 29,90 €           | B     | 1    | 410     |
| 1723 | 29,90 €           | B     | 1    | 410     |
| 1725 | 31,40 €           | B     | 1    | 338     |
| 1726 | 31,40 €           | B     | 1    | 338     |
| 1736 | 38,20 €           | B     | 1    | 338     |
| 1739 | 75,60 €           | B     | 1    | 343     |
| 1740 | 83,90 €           | B     | 1    | 343     |
| 1741 | 140,60 €          | B     | 1    | 369     |
| 1745 | 38,20 €           | B     | 1    | 336     |
| 1746 | 36,70 €           | B     | 1    | 336     |
| 1748 | 68,10 €           | B     | 1    | 382     |
| 1749 | 179,60 €          | B     | 1    | 370     |
| 1750 | 205,60 €          | B     | 1    | 370     |
| 1752 | 106,70 €          | B     | 1    | 382     |
| 1753 | 42,10 €           | B     | 1    | 336     |
| 1757 | 71,00 €           | B     | 4    | 378     |
| 1758 | 71,00 €           | B     | 4    | 378     |
| 1764 | 22,60 €           | B     | 1    | 120     |
| 1777 | 202,70 €          | B     | 1    | 352/402 |
| 1778 | 172,50 €          | B     | 1    | 402     |
| 1779 | 203,20 €          | B     | 1    | 402     |
| 1790 | 20,50 €           | B     | 10   | 443     |
| 1791 | 49,90 €           | B     | 1    | 443     |
| 1793 | 174,90 €          | B     | 1    | 402     |
| 1794 | 202,70 €          | B     | 1    | 352/402 |
| 1796 | 172,50 €          | B     | 1    | 402     |
| 1797 | 182,00 €          | B     | 1    | 402     |
| 1798 | 203,20 €          | B     | 1    | 402     |
| 1799 | 213,90 €          | B     | 1    | 402     |
| 1800 | 99,00 €           | B     | 1    | 255     |
| 1814 | 72,70 €           | B     | 1    | 378     |
| 1815 | 72,70 €           | B     | 1    | 378     |
| 1817 | 112,80 €          | B     | 1    | HC      |
| 1820 | 63,50 €           | B     | 1    | 252     |
| 1821 | 47,20 €           | B     | 1    | 253     |
| 1826 | 46,90 €           | A     | 1    | HC      |
| 1837 | 243,50 €          | B     | 1    | 402     |

| Code | Prix € HT 02/2020 | Prod. | U.E. | Page    |
|------|-------------------|-------|------|---------|
| 1840 | 112,50 €          | B     | 1    | 370     |
| 1842 | 101,90 €          | B     | 1    | 369     |
| 1845 | 39,20 €           | B     | 1    | 257     |
| 1855 | 172,70 €          | B     | 1    | 383     |
| 1856 | 610,90 €          | B     | 1    | 403     |
| 1857 | 100,00 €          | B     | 1    | 382     |
| 1858 | 172,50 €          | B     | 1    | 413     |
| 1859 | 95,70 €           | B     | 1    | 413     |
| 1862 | 92,70 €           | B     | 1    | 352     |
| 1889 | 92,70 €           | B     | 1    | 352     |
| 1892 | 633,40 €          | B     | 1    | 400     |
| 1893 | 422,20 €          | B     | 1    | 400     |
| 1894 | 70,40 €           | B     | 1    | 355/406 |
| 1895 | 70,40 €           | B     | 1    | 406     |
| 1896 | 80,30 €           | B     | 1    | 406     |
| 1897 | 111,20 €          | B     | 1    | 406     |
| 1898 | 39,80 €           | B     | 1    | 334     |
| 1899 | 64,80 €           | B     | 1    | 334     |
| 1925 | 306,00 €          | B     | 1    | 319     |
| 1927 | 76,00 €           | B     | 1    | 364     |
| 1928 | 76,00 €           | B     | 1    | 364     |
| 1930 | 107,00 €          | B     | 1    | 354     |
| 1931 | 107,00 €          | B     | 1    | 354     |
| 1932 | 107,00 €          | B     | 1    | 354     |
| 1933 | 81,70 €           | B     | 1    | 357     |
| 1934 | 81,70 €           | B     | 1    | 357     |
| 1937 | 92,90 €           | B     | 1    | 405     |
| 1938 | 92,90 €           | B     | 1    | 405     |
| 1940 | 76,00 €           | B     | 1    | 364     |
| 1941 | 81,70 €           | B     | 1    | 364     |
| 1942 | 108,40 €          | B     | 1    | 355     |
| 1943 | 108,40 €          | B     | 1    | 355     |
| 1944 | 108,40 €          | B     | 1    | 355     |
| 1945 | 66,20 €           | B     | 1    | 353/412 |
| 1946 | 77,40 €           | B     | 1    | 412     |
| 1947 | 105,60 €          | B     | 1    | 412     |
| 1948 | 154,70 €          | B     | 1    | 354     |
| 1949 | 146,60 €          | B     | 1    | 354     |
| 1950 | 34,90 €           | B     | 1    | 443     |
| 1951 | 21,80 €           | B     | 1    | 443     |
| 1952 | 70,70 €           | B     | 1    | 443     |
| 1953 | 11,80 €           | B     | 1    | 443     |
| 1954 | 41,40 €           | B     | 1    | 111/425 |
| 1955 | 37,80 €           | B     | 1    | 117/424 |
| 1956 | 37,80 €           | B     | 1    | 117/424 |
| 1970 | 1,00 €            | B     | 10   | 445     |
| 1971 | 0,50 €            | B     | 10   | 445     |
| 1972 | 0,90 €            | B     | 10   | 445     |
| 1973 | 0,70 €            | B     | 10   | 445     |
| 1976 | 0,70 €            | B     | 10   | 445     |
| 1978 | 13,70 €           | B     | 1    | 287     |
| 1979 | 37,60 €           | B     | 1    | 287     |
| 1980 | 53,00 €           | B     | 1    | 287     |
| 1985 | 21,20 €           | B     | 1    | 357/408 |
| 1986 | 21,20 €           | B     | 1    | 357/408 |
| 1992 | 71,40 €           | B     | 1    | HC      |
| 1994 | 204,00 €          | B     | 1    | 319     |
| 1996 | 48,50 €           | B     | 1    | HC      |
| 2002 | 9,30 €            | B     | 1    | HC      |
| 2004 | 9,30 €            | B     | 1    | HC      |
| 2018 | 2,00 €            | B     | 1    | 414     |
| 2051 | 33,80 €           | B     | 1    | 415     |
| 2052 | 33,80 €           | B     | 1    | 415     |
| 2053 | 66,20 €           | B     | 1    | 415     |
| 2054 | 21,30 €           | B     | 1    | 290     |
| 2055 | 71,80 €           | B     | 1    | 415     |
| 2056 | 71,80 €           | B     | 1    | 415     |
| 2057 | 128,10 €          | B     | 1    | 415     |
| 2059 | 170,30 €          | B     | 1    | 416     |
| 2060 | 188,60 €          | B     | 1    | 416     |
| 2061 | 222,40 €          | B     | 1    | 416     |

Ces prix sont valables en France métropolitaine et Dom-Tom.

# LISTE DES CODES (2063 à 2975) - TARIFS 02/2020

| Code | Prix € HT 02/2020 | Prod. | U.E. | Page |
|------|-------------------|-------|------|------|
| 2063 | 236,40 €          | B     | 1    | 416  |
| 2075 | 63,00 €           | B     | 1    | HC   |
| 2079 | 68,20 €           | B     | 1    | HC   |
| 2082 | 61,00 €           | B     | 1    | HC   |
| 2084 | 63,00 €           | B     | 1    | HC   |
| 2091 | 66,00 €           | B     | 1    | 444  |
| 2098 | 38,70 €           | B     | 1    | HC   |
| 2100 | 38,90 €           | B     | 1    | HC   |
| 2103 | 16,20 €           | B     | 1    | 444  |
| 2104 | 16,20 €           | B     | 1    | 444  |
| 2106 | 2,80 €            | B     | 1    | HC   |
| 2107 | 16,20 €           | B     | 1    | 444  |
| 2108 | 16,20 €           | B     | 1    | 444  |
| 2110 | 15,20 €           | B     | 1    | 444  |
| 2111 | 15,20 €           | B     | 1    | 444  |
| 2112 | 21,00 €           | B     | 1    | 444  |
| 2113 | 21,00 €           | B     | 1    | 444  |
| 2124 | 64,80 €           | B     | 1    | 408  |
| 2125 | 64,80 €           | B     | 1    | 409  |
| 2127 | 59,10 €           | B     | 1    | 416  |
| 2128 | 34,10 €           | B     | 1    | HC   |
| 2130 | 34,10 €           | B     | 1    | HC   |
| 2131 | 34,10 €           | B     | 1    | HC   |
| 2132 | 34,10 €           | B     | 1    | HC   |
| 2133 | 34,10 €           | B     | 1    | HC   |
| 2135 | 34,10 €           | B     | 1    | HC   |
| 2136 | 34,10 €           | B     | 1    | HC   |
| 2137 | 34,10 €           | B     | 1    | HC   |
| 2139 | 34,10 €           | B     | 1    | HC   |
| 2140 | 8,40 €            | B     | 1    | 430  |
| 2141 | 12,70 €           | B     | 1    | 430  |
| 2149 | 31,10 €           | B     | 1    | 414  |
| 2162 | 6,80 €            | B     | 1    | HC   |
| 2166 | 59,10 €           | B     | 1    | 453  |
| 2167 | 59,10 €           | B     | 1    | 423  |
| 2168 | 3,70 €            | B     | 1    | HC   |
| 2171 | 6,30 €            | B     | 1    | HC   |
| 2172 | 140,10 €          | B     | 1    | HC   |
| 2182 | 20,40 €           | B     | 1    | 422  |
| 2195 | 10,10 €           | B     | 1    | HC   |
| 2196 | 17,50 €           | B     | 1    | HC   |
| 2197 | 18,80 €           | B     | 1    | HC   |
| 2198 | 18,80 €           | B     | 1    | HC   |
| 2201 | 34,10 €           | B     | 1    | 339  |
| 2202 | 34,10 €           | B     | 1    | 339  |
| 2204 | 49,80 €           | B     | 1    | HC   |
| 2205 | 40,70 €           | B     | 1    | 339  |
| 2206 | 40,70 €           | B     | 1    | 339  |
| 2220 | 140,80 €          | B     | 1    | HC   |
| 2221 | 168,30 €          | B     | 1    | HC   |
| 2228 | 52,70 €           | A     | 1    | HC   |
| 2312 | 72,70 €           | B     | 1    | HC   |
| 2313 | 70,10 €           | B     | 1    | HC   |
| 2315 | 84,50 €           | B     | 1    | HC   |
| 2317 | 118,70 €          | B     | 1    | HC   |
| 2362 | 0,50 €            | B     | 1    | HC   |
| 2363 | 0,50 €            | B     | 1    | HC   |
| 2365 | 0,50 €            | B     | 1    | HC   |
| 2375 | 185,60 €          | B     | 1    | HC   |
| 2376 | 18,10 €           | B     | 1    | 190  |
| 2377 | 1,10 €            | B     | 10   | 205  |
| 2379 | 27,60 €           | B     | 1    | HC   |
| 2384 | 18,90 €           | B     | 1    | 190  |
| 2390 | 187,70 €          | B     | 1    | 202  |
| 2391 | 187,70 €          | B     | 1    | 202  |
| 2392 | 333,50 €          | B     | 1    | HC   |
| 2393 | 333,50 €          | B     | 1    | HC   |
| 2394 | 373,30 €          | B     | 1    | HC   |
| 2395 | 373,30 €          | B     | 1    | HC   |
| 2396 | 418,20 €          | B     | 1    | 202  |
| 2397 | 418,20 €          | B     | 1    | 202  |

| Code | Prix € HT 02/2020 | Prod. | U.E. | Page |
|------|-------------------|-------|------|------|
| 2401 | 79,50 €           | B     | 1    | 173  |
| 2402 | 81,50 €           | B     | 1    | 173  |
| 2437 | 53,20 €           | B     | 1    | HC   |
| 2439 | 53,20 €           | B     | 1    | HC   |
| 2551 | 8,10 €            | A     | 10   | 30   |
| 2552 | 22,50 €           | A     | 1    | 38   |
| 2554 | 22,00 €           | A     | 1    | 30   |
| 2555 | 4,70 €            | A     | 10   | HC   |
| 2566 | 13,70 €           | A     | 1    | 31   |
| 2567 | 13,70 €           | A     | 1    | 31   |
| 2569 | 20,50 €           | A     | 1    | 31   |
| 2570 | 3,30 €            | A     | 1    | 37   |
| 2571 | 3,20 €            | A     | 1    | 37   |
| 2572 | 3,50 €            | A     | 1    | 37   |
| 2573 | 3,80 €            | A     | 1    | 37   |
| 2574 | 3,90 €            | A     | 1    | 37   |
| 2575 | 4,20 €            | A     | 1    | 37   |
| 2576 | 10,50 €           | A     | 1    | 30   |
| 2580 | 17,10 €           | A     | 10   | HC   |
| 2582 | 20,50 €           | A     | 1    | 31   |
| 2583 | 23,90 €           | A     | 1    | 31   |
| 2585 | 14,30 €           | A     | 1    | 31   |
| 2586 | 14,30 €           | A     | 1    | 31   |
| 2588 | 6,30 €            | A     | 1    | 37   |
| 2589 | 7,10 €            | A     | 1    | 37   |
| 2590 | 7,90 €            | A     | 1    | 37   |
| 2596 | 3,10 €            | A     | 1    | HC   |
| 2601 | 26,20 €           | A     | 10   | 38   |
| 2602 | 10,10 €           | A     | 1    | HC   |
| 2603 | 26,20 €           | A     | 10   | 38   |
| 2605 | 67,30 €           | B     | 1    | HC   |
| 2606 | 108,10 €          | B     | 1    | HC   |
| 2611 | 52,90 €           | A     | 1    | 38   |
| 2625 | 5,10 €            | A     | 10   | HC   |
| 2626 | 7,10 €            | A     | 1    | 37   |
| 2627 | 6,80 €            | A     | 10   | 37   |
| 2628 | 9,00 €            | A     | 10   | 37   |
| 2630 | 154,00 €          | B     | 1    | HC   |
| 2631 | 5,10 €            | A     | 10   | HC   |
| 2635 | 5,60 €            | A     | 10   | HC   |
| 2647 | 17,50 €           | A     | 10   | 34   |
| 2648 | 18,70 €           | A     | 10   | 34   |
| 2649 | 5,30 €            | A     | 10   | HC   |
| 2650 | 5,40 €            | A     | 10   | HC   |
| 2651 | 5,40 €            | A     | 10   | HC   |
| 2655 | 3,80 €            | A     | 1    | 37   |
| 2656 | 3,90 €            | A     | 1    | 37   |
| 2657 | 4,00 €            | A     | 1    | 37   |
| 2658 | 4,10 €            | A     | 1    | 37   |
| 2659 | 4,10 €            | A     | 1    | 37   |
| 2660 | 4,20 €            | A     | 1    | 37   |
| 2661 | 4,20 €            | A     | 1    | 37   |
| 2662 | 3,70 €            | A     | 1    | 37   |
| 2663 | 3,90 €            | A     | 1    | 37   |
| 2664 | 5,60 €            | A     | 1    | 37   |
| 2665 | 2,50 €            | A     | 1    | 37   |
| 2666 | 2,40 €            | A     | 1    | 37   |
| 2667 | 3,20 €            | A     | 1    | 37   |
| 2668 | 8,80 €            | A     | 1    | 37   |
| 2669 | 9,30 €            | A     | 1    | 37   |
| 2673 | 28,60 €           | A     | 1    | HC   |
| 2680 | 5,10 €            | A     | 1    | HC   |
| 2696 | 52,90 €           | A     | 1    | 38   |
| 2706 | 54,90 €           | A     | 1    | HC   |
| 2707 | 54,90 €           | A     | 1    | HC   |
| 2708 | 5,60 €            | A     | 10   | 28   |
| 2718 | 7,10 €            | A     | 1    | HC   |
| 2745 | 30,60 €           | A     | 1    | HC   |
| 2765 | 5,80 €            | A     | 10   | 28   |
| 2766 | 6,30 €            | A     | 10   | 28   |
| 2773 | 6,30 €            | A     | 10   | 28   |

| Code | Prix € HT 02/2020 | Prod. | U.E. | Page |
|------|-------------------|-------|------|------|
| 2777 | 2,20 €            | A     | 10   | 17   |
| 2778 | 7,50 €            | A     | 10   | 28   |
| 2818 | 5,80 €            | A     | 10   | 28   |
| 2820 | 2,50 €            | A     | 1    | HC   |
| 2831 | 8,80 €            | A     | 10   | HC   |
| 2832 | 8,80 €            | A     | 10   | HC   |
| 2857 | 26,20 €           | A     | 1    | 38   |
| 2858 | 26,20 €           | A     | 1    | 38   |
| 2861 | 6,20 €            | A     | 1    | 37   |
| 2862 | 6,20 €            | A     | 1    | 37   |
| 2863 | 8,30 €            | A     | 1    | 37   |
| 2864 | 8,90 €            | A     | 1    | 37   |
| 2865 | 9,40 €            | A     | 1    | 37   |
| 2866 | 6,90 €            | A     | 1    | 37   |
| 2867 | 7,40 €            | A     | 1    | 37   |
| 2871 | 28,60 €           | A     | 10   | 34   |
| 2872 | 38,80 €           | A     | 10   | 34   |
| 2873 | 9,90 €            | A     | 1    | 36   |
| 2874 | 112,20 €          | A     | 1    | HC   |
| 2875 | 134,60 €          | A     | 1    | HC   |
| 2876 | 44,40 €           | A     | 1    | 36   |
| 2877 | 9,30 €            | A     | 1    | 30   |
| 2882 | 39,80 €           | A     | 1    | HC   |
| 2883 | 39,80 €           | A     | 1    | HC   |
| 2890 | 6,90 €            | A     | 10   | 19   |
| 2894 | 7,10 €            | A     | 1    | 23   |
| 2896 | 13,50 €           | A     | 1    | HC   |
| 2897 | 6,90 €            | A     | 10   | 19   |
| 2907 | 136,70 €          | B     | 1    | 190  |
| 2908 | 97,90 €           | B     | 1    | 190  |
| 2909 | 59,20 €           | B     | 1    | 190  |
| 2910 | 184,60 €          | B     | 1    | HC   |
| 2911 | 220,30 €          | B     | 1    | HC   |
| 2914 | 36,70 €           | B     | 1    | 190  |
| 2917 | 136,70 €          | B     | 1    | 190  |
| 2918 | 97,90 €           | B     | 1    | 190  |
| 2919 | 59,20 €           | B     | 1    | 190  |
| 2920 | 184,60 €          | B     | 1    | HC   |
| 2921 | 220,30 €          | B     | 1    | HC   |
| 2922 | 202,00 €          | B     | 1    | 190  |
| 2923 | 202,00 €          | B     | 1    | 190  |
| 2924 | 241,70 €          | B     | 1    | 190  |
| 2925 | 241,70 €          | B     | 1    | 190  |
| 2926 | 266,20 €          | B     | 1    | 190  |
| 2927 | 266,20 €          | B     | 1    | 190  |
| 2928 | 16,30 €           | A     | 10   | 29   |
| 2929 | 22,40 €           | A     | 10   | 29   |
| 2935 | 36,70 €           | A     | 10   | HC   |
| 2938 | 5,10 €            | A     | 10   | 23   |
| 2939 | 5,10 €            | A     | 10   | 22   |
| 2940 | 5,10 €            | A     | 10   | 20   |
| 2942 | 27,20 €           | A     | 10   | 27   |
| 2943 | 12,00 €           | A     | 10   | 33   |
| 2946 | 15,30 €           | A     | 10   | 32   |
| 2948 | 10,50 €           | A     | 10   | 18   |
| 2949 | 10,50 €           | A     | 10   | 18   |
| 2951 | 28,60 €           | A     | 10   | 28   |
| 2954 | 10,50 €           | A     | 1    | 18   |
| 2955 | 10,50 €           | A     | 10   | 18   |
| 2956 | 6,10 €            | A     | 10   | 20   |
| 2958 | 18,40 €           | A     | 5    | 22   |
| 2959 | 44,90 €           | A     | 10   | 27   |
| 2960 | 15,30 €           | A     | 10   | 20   |
| 2962 | 6,10 €            | A     | 10   | HC   |
| 2963 | 22,40 €           | A     | 10   | 26   |
| 2964 | 15,30 €           | A     | 10   | 26   |
| 2971 | 12,00 €           | A     | 10   | 33   |
| 2972 | 22,40 €           | A     | 10   | 29   |
| 2973 | 85,20 €           | B     | 1    | HC   |
| 2974 | 85,20 €           | B     | 1    | HC   |
| 2975 | 6,80 €            | A     | 10   | 17   |

Ces prix sont valables en France métropolitaine et Dom-Tom.

NC : nous consulter - HC : hors catalogue



# LISTE DES CODES (2976 à 4189) - TARIFS 02/2020

| Code | Prix € HT 02/2020 | Prod. | U.E. | Page    |
|------|-------------------|-------|------|---------|
| 2976 | 6,80 €            | A     | 10   | 17      |
| 2978 | 19,10 €           | A     | 10   | HC      |
| 2979 | 11,20 €           | A     | 10   | 26      |
| 2980 | 43,90 €           | A     | 10   | 27      |
| 2981 | 4,10 €            | A     | 10   | 18      |
| 2982 | 4,10 €            | A     | 10   | 18      |
| 2985 | 85,20 €           | B     | 1    | HC      |
| 2986 | 85,20 €           | B     | 1    | HC      |
| 2987 | 13,30 €           | A     | 10   | 26      |
| 2988 | 17,30 €           | A     | 10   | 26      |
| 2990 | 9,20 €            | A     | 10   | HC      |
| 2991 | 5,90 €            | A     | 1    | 22      |
| 2992 | 27,20 €           | A     | 1    | 27      |
| 2993 | 8,20 €            | A     | 10   | 19      |
| 2994 | 8,20 €            | A     | 10   | 19      |
| 2995 | 43,90 €           | A     | 10   | 27      |
| 2997 | 6,10 €            | A     | 1    | 18      |
| 2998 | 6,10 €            | A     | 1    | 18      |
| 2999 | 12,00 €           | A     | 10   | 33      |
| 3000 | 89,10 €           | B     | 1    | 246     |
| 3001 | 106,40 €          | B     | 1    | 249     |
| 3002 | 103,40 €          | B     | 1    | 246     |
| 3003 | 116,70 €          | B     | 1    | 249     |
| 3004 | 103,00 €          | B     | 1    | 249     |
| 3005 | 113,80 €          | B     | 1    | 248     |
| 3006 | 184,40 €          | B     | 1    | 248     |
| 3007 | 173,70 €          | B     | 1    | 249     |
| 3008 | 199,80 €          | B     | 1    | 248     |
| 3009 | 202,90 €          | B     | 1    | 247     |
| 3010 | 110,70 €          | B     | 1    | 247     |
| 3011 | 110,70 €          | B     | 1    | 247     |
| 3018 | 126,10 €          | B     | 1    | HC      |
| 3019 | 107,60 €          | B     | 1    | HC      |
| 3021 | 184,40 €          | B     | 1    | 250     |
| 3022 | 130,70 €          | B     | 1    | 250     |
| 3023 | 174,00 €          | B     | 1    | 245     |
| 3025 | 174,00 €          | B     | 1    | 245     |
| 3026 | 153,60 €          | B     | 1    | HC      |
| 3027 | 174,00 €          | B     | 1    | 245     |
| 3028 | 153,60 €          | B     | 1    | HC      |
| 3029 | 127,60 €          | B     | 1    | 246     |
| 3030 | 101,30 €          | B     | 1    | 356/408 |
| 3031 | 101,30 €          | B     | 1    | 356/408 |
| 3032 | 101,30 €          | B     | 1    | 356/408 |
| 3033 | 135,20 €          | B     | 1    | 356/408 |
| 3034 | 101,30 €          | B     | 1    | 356/408 |
| 3035 | 101,30 €          | B     | 1    | 356/408 |
| 3036 | 101,30 €          | B     | 1    | 356/408 |
| 3037 | 135,20 €          | B     | 1    | 356/408 |
| 3038 | 101,30 €          | B     | 1    | 408     |
| 3039 | 101,30 €          | B     | 1    | 408     |
| 3040 | 101,30 €          | B     | 1    | 408     |
| 3041 | 143,60 €          | B     | 1    | 408     |
| 3042 | 116,80 €          | B     | 1    | 408     |
| 3043 | 116,80 €          | B     | 1    | 408     |
| 3044 | 116,80 €          | B     | 1    | 408     |
| 3045 | 149,20 €          | B     | 1    | 408     |
| 3046 | 135,20 €          | B     | 1    | 408     |
| 3047 | 135,20 €          | B     | 1    | 408     |
| 3048 | 135,20 €          | B     | 1    | 408     |
| 3049 | 171,70 €          | B     | 1    | 408     |
| 3051 | 174,00 €          | B     | 1    | 245     |
| 3052 | 153,60 €          | B     | 1    | HC      |
| 3053 | 174,00 €          | B     | 1    | 245     |
| 3054 | 174,00 €          | B     | 1    | 245     |
| 3056 | 119,30 €          | B     | 1    | 251     |
| 3058 | 284,30 €          | B     | 1    | 408     |
| 3059 | 284,30 €          | B     | 1    | 408     |
| 3060 | 284,30 €          | B     | 1    | 408     |
| 3061 | 322,30 €          | B     | 1    | 408     |
| 3062 | 480,00 €          | B     | 1    | 409     |

| Code | Prix € HT 02/2020 | Prod. | U.E. | Page    |
|------|-------------------|-------|------|---------|
| 3063 | 480,00 €          | B     | 1    | 409     |
| 3064 | 480,00 €          | B     | 1    | 409     |
| 3065 | 515,20 €          | B     | 1    | 409     |
| 3066 | 518,00 €          | B     | 1    | 409     |
| 3067 | 518,00 €          | B     | 1    | 409     |
| 3068 | 518,00 €          | B     | 1    | 409     |
| 3069 | 546,10 €          | B     | 1    | 409     |
| 3070 | 647,50 €          | B     | 1    | 409     |
| 3071 | 647,50 €          | B     | 1    | 409     |
| 3072 | 647,50 €          | B     | 1    | 409     |
| 3073 | 723,50 €          | B     | 1    | 409     |
| 3074 | 746,00 €          | B     | 1    | 409     |
| 3075 | 746,00 €          | B     | 1    | 409     |
| 3076 | 746,00 €          | B     | 1    | 409     |
| 3077 | 845,90 €          | B     | 1    | 409     |
| 3081 | 127,30 €          | B     | 1    | 357     |
| 3083 | 168,50 €          | B     | 1    | 357     |
| 3114 | 236,30 €          | B     | 1    | HC      |
| 3118 | 39,00 €           | B     | 1    | HC      |
| 3119 | 32,00 €           | B     | 1    | HC      |
| 3120 | 219,80 €          | B     | 1    | 351/397 |
| 3122 | 219,80 €          | B     | 1    | 351/397 |
| 3123 | 202,10 €          | B     | 1    | 397     |
| 3124 | 213,90 €          | B     | 1    | 397     |
| 3125 | 202,10 €          | B     | 1    | 397     |
| 3126 | 219,80 €          | B     | 1    | 397     |
| 3127 | 232,80 €          | B     | 1    | 397     |
| 3128 | 219,80 €          | B     | 1    | 397     |
| 3129 | 502,90 €          | B     | 1    | 396     |
| 3130 | 430,70 €          | B     | 1    | 416     |
| 3131 | 454,60 €          | B     | 1    | 416     |
| 3133 | 200,90 €          | B     | 1    | 352/402 |
| 3134 | 174,90 €          | B     | 1    | 402     |
| 3135 | 219,80 €          | B     | 1    | 402     |
| 3136 | 46,00 €           | B     | 1    | 346     |
| 3137 | 36,00 €           | B     | 1    | 346     |
| 3138 | 82,00 €           | B     | 1    | 348     |
| 3144 | 29,60 €           | B     | 1    | 316     |
| 3145 | 29,60 €           | B     | 1    | 316     |
| 3235 | 62,60 €           | B     | 1    | HC      |
| 3562 | 22,40 €           | B     | 1    | 405     |
| 3630 | 4,70 €            | B     | 1    | 340     |
| 3632 | 5,30 €            | B     | 1    | 340     |
| 3637 | 11,70 €           | B     | 1    | 340     |
| 3647 | 37,10 €           | B     | 1    | 272/332 |
| 3649 | 25,50 €           | B     | 1    | 270/333 |
| 3650 | 22,30 €           | B     | 1    | 337     |
| 3670 | 6,00 €            | B     | 1    | 97/420  |
| 3671 | 12,20 €           | B     | 1    | 42/421  |
| 3727 | 30,90 €           | B     | 1    | 181     |
| 3819 | 34,90 €           | B     | 1    | HC      |
| 3825 | 37,70 €           | B     | 1    | HC      |
| 3826 | 64,60 €           | B     | 1    | HC      |
| 3830 | 29,20 €           | B     | 1    | HC      |
| 3836 | 36,30 €           | B     | 1    | HC      |
| 3837 | 29,20 €           | B     | 1    | HC      |
| 3840 | 23,30 €           | B     | 1    | HC      |
| 3841 | 25,70 €           | B     | 1    | HC      |
| 3842 | 30,50 €           | B     | 1    | HC      |
| 3843 | 18,20 €           | B     | 1    | HC      |
| 3902 | 16,50 €           | B     | 1    | HC      |
| 3925 | 38,80 €           | B     | 1    | 121     |
| 3926 | 38,80 €           | B     | 1    | 121     |
| 3927 | 25,80 €           | B     | 1    | HC      |
| 3928 | 38,80 €           | B     | 1    | 121     |
| 3929 | 38,80 €           | B     | 1    | 121     |
| 3931 | 54,10 €           | B     | 1    | 184     |
| 3932 | 73,40 €           | B     | 1    | 184     |
| 3941 | 48,00 €           | B     | 1    | 232     |
| 3942 | 31,70 €           | B     | 1    | HC      |
| 3970 | 42,10 €           | B     | 1    | 273     |

| Code | Prix € HT 02/2020 | Prod. | U.E. | Page    |
|------|-------------------|-------|------|---------|
| 3971 | 83,00 €           | B     | 1    | 273     |
| 3972 | 30,70 €           | B     | 1    | 255     |
| 3973 | 46,60 €           | B     | 1    | 253     |
| 3974 | 43,20 €           | B     | 1    | 255     |
| 3976 | 87,50 €           | B     | 1    | 253     |
| 3977 | 62,50 €           | B     | 1    | 253     |
| 3978 | 54,50 €           | B     | 1    | 252     |
| 3979 | 75,00 €           | B     | 1    | 252     |
| 3991 | 9,70 €            | B     | 1    | 435     |
| 4004 | 96,50 €           | B     | 1    | 273/335 |
| 4011 | 69,30 €           | C     | 1    | HC      |
| 4013 | 36,70 €           | C     | 1    | HC      |
| 4014 | 36,70 €           | C     | 1    | HC      |
| 4020 | 313,10 €          | B     | 1    | 395     |
| 4021 | 335,70 €          | B     | 1    | 395     |
| 4023 | 335,70 €          | B     | 1    | 395     |
| 4045 | 12,10 €           | C     | 1    | HC      |
| 4066 | 15,70 €           | C     | 1    | 83      |
| 4067 | 11,00 €           | B     | 1    | 85      |
| 4068 | 14,00 €           | B     | 1    | 85      |
| 4069 | 14,60 €           | C     | 1    | 83      |
| 4070 | 196,70 €          | B     | 1    | 357/407 |
| 4072 | 696,50 €          | B     | 1    | 407     |
| 4075 | 14,20 €           | C     | 1    | 83      |
| 4076 | 12,80 €           | B     | 1    | 82      |
| 4077 | 12,80 €           | B     | 1    | 82      |
| 4080 | 196,70 €          | B     | 1    | 357/407 |
| 4082 | 696,50 €          | B     | 1    | 407     |
| 4083 | 859,40 €          | B     | 1    | 407     |
| 4084 | 859,40 €          | B     | 1    | 407     |
| 4087 | 11,20 €           | C     | 1    | 84      |
| 4095 | 28,20 €           | C     | 1    | 83      |
| 4106 | 23,50 €           | C     | 1    | 80      |
| 4121 | 18,40 €           | C     | 15   | HC      |
| 4126 | 48,50 €           | C     | 1    | HC      |
| 4127 | 48,50 €           | C     | 1    | HC      |
| 4131 | 22,30 €           | C     | 1    | 98      |
| 4132 | 22,30 €           | C     | 1    | 98      |
| 4133 | 23,40 €           | C     | 1    | 98      |
| 4134 | 23,40 €           | C     | 1    | 98      |
| 4144 | 19,40 €           | B     | 1    | 99      |
| 4145 | 19,40 €           | B     | 1    | 99      |
| 4146 | 21,40 €           | B     | 1    | 99      |
| 4147 | 21,40 €           | B     | 1    | 99      |
| 4148 | 36,70 €           | B     | 1    | 142     |
| 4149 | 49,00 €           | B     | 1    | 144     |
| 4150 | 131,60 €          | B     | 1    | 142     |
| 4151 | 113,20 €          | B     | 1    | 142     |
| 4157 | 198,90 €          | B     | 1    | 143     |
| 4158 | 298,90 €          | B     | 1    | 143     |
| 4159 | 36,70 €           | B     | 1    | 142     |
| 4160 | 49,00 €           | B     | 1    | 144     |
| 4161 | 131,60 €          | B     | 1    | 142     |
| 4162 | 113,20 €          | B     | 1    | 142     |
| 4163 | 198,90 €          | B     | 1    | 143     |
| 4164 | 298,90 €          | B     | 1    | 143     |
| 4166 | 11,80 €           | B     | 1    | HC      |
| 4167 | 5,90 €            | B     | 1    | HC      |
| 4168 | 11,80 €           | B     | 1    | HC      |
| 4169 | NC                | B     | 1    | HC      |
| 4170 | 34,40 €           | C     | 1    | 107     |
| 4171 | 66,30 €           | C     | 1    | 107     |
| 4175 | 92,20 €           | B     | 1    | 282     |
| 4176 | 128,80 €          | B     | 1    | 282     |
| 4177 | 185,50 €          | B     | 1    | 283     |
| 4178 | 263,60 €          | B     | 1    | 283     |
| 4180 | 34,40 €           | C     | 1    | 107     |
| 4181 | 66,30 €           | C     | 1    | 107     |
| 4183 | 92,40 €           | B     | 1    | 278     |
| 4184 | 92,40 €           | B     | 1    | 278     |
| 4189 | 49,40 €           | C     | 1    | HC      |

Ces prix sont valables en France métropolitaine et Dom-Tom.

# LISTE DES CODES (4190 à 5127) - TARIFS 02/2020

| Code | Prix € HT<br>02/2020 | Prod. | U.E. | Page    |
|------|----------------------|-------|------|---------|
| 4190 | 87,70 €              | B     | 1    | 284     |
| 4191 | 87,70 €              | B     | 1    | 284     |
| 4192 | 135,70 €             | B     | 1    | 284     |
| 4193 | 135,70 €             | B     | 1    | 284     |
| 4194 | 250,90 €             | B     | 1    | 281     |
| 4196 | 22,30 €              | B     | 1    | 63      |
| 4197 | 22,30 €              | B     | 1    | 63      |
| 4204 | 53,00 €              | B     | 1    | 279     |
| 4205 | 53,00 €              | B     | 1    | 279     |
| 4207 | 35,70 €              | B     | 1    | 280     |
| 4208 | 58,10 €              | B     | 1    | 280     |
| 4209 | 57,10 €              | B     | 1    | 280     |
| 4210 | 58,10 €              | B     | 1    | 280     |
| 4214 | 47,90 €              | B     | 1    | 292     |
| 4216 | 47,90 €              | B     | 1    | 292     |
| 4217 | 70,40 €              | B     | 1    | 292     |
| 4218 | 70,40 €              | B     | 1    | 292     |
| 4223 | 105,00 €             | B     | 1    | HC      |
| 4224 | 105,00 €             | B     | 1    | HC      |
| 4240 | 25,50 €              | C     | 1    | 63      |
| 4241 | 25,50 €              | C     | 1    | 63      |
| 4242 | 36,10 €              | C     | 1    | 63      |
| 4243 | 36,10 €              | C     | 1    | 63      |
| 4244 | 46,70 €              | C     | 1    | 63      |
| 4245 | 46,70 €              | C     | 1    | 63      |
| 4246 | 64,70 €              | C     | 1    | 63      |
| 4247 | 64,70 €              | C     | 1    | 63      |
| 4253 | 109,00 €             | B     | 1    | 285     |
| 4254 | 109,00 €             | B     | 1    | 285     |
| 4255 | 66,90 €              | C     | 1    | HC      |
| 4259 | 53,40 €              | C     | 1    | HC      |
| 4261 | 48,00 €              | C     | 1    | HC      |
| 4265 | 252,90 €             | B     | 1    | HC      |
| 4266 | 252,90 €             | B     | 1    | HC      |
| 4267 | 238,70 €             | B     | 1    | HC      |
| 4268 | 252,90 €             | B     | 1    | HC      |
| 4269 | 252,90 €             | B     | 1    | HC      |
| 4273 | 37,50 €              | C     | 1    | 63      |
| 4274 | 37,50 €              | C     | 1    | 63      |
| 4277 | 74,20 €              | C     | 1    | HC      |
| 4280 | 252,90 €             | B     | 1    | HC      |
| 4281 | 252,90 €             | B     | 1    | HC      |
| 4282 | 238,70 €             | B     | 1    | HC      |
| 4286 | 307,30 €             | B     | 1    | HC      |
| 4288 | 301,40 €             | B     | 1    | HC      |
| 4289 | 307,30 €             | B     | 1    | HC      |
| 4290 | 307,30 €             | B     | 1    | HC      |
| 4291 | 301,40 €             | B     | 1    | HC      |
| 4311 | 15,30 €              | C     | 1    | 107     |
| 4317 | 25,50 €              | C     | 1    | HC      |
| 4340 | 123,80 €             | C     | 1    | HC      |
| 4341 | 123,80 €             | C     | 1    | HC      |
| 4353 | 130,60 €             | C     | 1    | HC      |
| 4354 | 130,60 €             | C     | 1    | HC      |
| 4363 | 134,30 €             | C     | 1    | HC      |
| 4377 | 180,90 €             | B     | 1    | HC      |
| 4385 | 55,00 €              | B     | 1    | 144     |
| 4386 | 55,00 €              | B     | 1    | 144     |
| 4387 | 65,00 €              | B     | 1    | 144     |
| 4388 | 65,00 €              | B     | 1    | 144     |
| 4389 | 76,00 €              | B     | 1    | 145/262 |
| 4390 | 76,00 €              | B     | 1    | 145/262 |
| 4422 | 137,00 €             | C     | 1    | HC      |
| 4511 | 194,60 €             | B     | 1    | HC      |
| 4517 | 16,20 €              | B     | 10   | HC      |
| 4527 | 16,80 €              | B     | 10   | HC      |
| 4528 | 15,10 €              | B     | 10   | HC      |
| 4549 | 8,60 €               | B     | 1    | 104     |
| 4550 | 9,80 €               | B     | 1    | 103     |
| 4552 | 35,20 €              | C     | 1    | HC      |
| 4557 | 7,90 €               | B     | 1    | 104     |

| Code | Prix € HT<br>02/2020 | Prod. | U.E. | Page |
|------|----------------------|-------|------|------|
| 4558 | 8,90 €               | B     | 1    | 104  |
| 4559 | 9,30 €               | B     | 1    | 103  |
| 4560 | 11,90 €              | B     | 1    | 103  |
| 4563 | 9,90 €               | B     | 1    | 104  |
| 4564 | 7,90 €               | B     | 1    | 104  |
| 4565 | 13,00 €              | B     | 1    | 103  |
| 4566 | 9,30 €               | B     | 1    | 103  |
| 4571 | 9,60 €               | B     | 1    | 104  |
| 4572 | 7,60 €               | B     | 1    | 104  |
| 4579 | 10,80 €              | B     | 1    | 103  |
| 4580 | 8,80 €               | B     | 1    | 103  |
| 4600 | 6,40 €               | C     | 4    | 105  |
| 4601 | 6,40 €               | C     | 1    | HC   |
| 4603 | 8,30 €               | C     | 4    | HC   |
| 4605 | 8,30 €               | C     | 1    | 105  |
| 4607 | 19,20 €              | B     | 1    | HC   |
| 4612 | 70,50 €              | C     | 4    | HC   |
| 4618 | 90,30 €              | C     | 1    | HC   |
| 4620 | 39,80 €              | B     | 1    | 80   |
| 4629 | 42,60 €              | B     | 1    | HC   |
| 4630 | 95,70 €              | B     | 1    | 379  |
| 4631 | 79,20 €              | B     | 1    | 379  |
| 4633 | 79,20 €              | B     | 1    | 379  |
| 4648 | 132,40 €             | B     | 1    | 380  |
| 4649 | 144,20 €             | B     | 1    | 380  |
| 4655 | 132,40 €             | B     | 1    | 381  |
| 4656 | 10,70 €              | C     | 1    | 108  |
| 4661 | 132,40 €             | B     | 1    | 381  |
| 4662 | 18,80 €              | B     | 1    | 158  |
| 4663 | 40,10 €              | B     | 1    | 159  |
| 4664 | 60,10 €              | B     | 1    | 159  |
| 4665 | 60,10 €              | B     | 1    | 158  |
| 4666 | 126,40 €             | B     | 1    | 380  |
| 4667 | 132,40 €             | B     | 1    | 380  |
| 4669 | 27,50 €              | C     | 1    | HC   |
| 4671 | 31,40 €              | B     | 1    | 163  |
| 4684 | 14,20 €              | B     | 1    | HC   |
| 4685 | 163,30 €             | B     | 1    | 325  |
| 4691 | 13,10 €              | C     | 10   | HC   |
| 4694 | 16,60 €              | C     | 10   | HC   |
| 4700 | 321,60 €             | B     | 1    | HC   |
| 4701 | 379,50 €             | B     | 1    | HC   |
| 4702 | 620,50 €             | B     | 1    | HC   |
| 4704 | 435,20 €             | B     | 1    | HC   |
| 4705 | 445,40 €             | B     | 1    | HC   |
| 4706 | 377,30 €             | B     | 1    | HC   |
| 4707 | 386,30 €             | B     | 1    | HC   |
| 4708 | 718,20 €             | B     | 1    | HC   |
| 4709 | 728,40 €             | B     | 1    | HC   |
| 4714 | 66,40 €              | C     | 1    | 232  |
| 4723 | 49,00 €              | C     | 1    | HC   |
| 4724 | 34,70 €              | C     | 1    | HC   |
| 4725 | 28,40 €              | B     | 1    | 106  |
| 4726 | 53,00 €              | B     | 1    | 106  |
| 4750 | 561,30 €             | B     | 1    | HC   |
| 4751 | 668,20 €             | B     | 1    | HC   |
| 4752 | 657,90 €             | B     | 1    | HC   |
| 4757 | 179,60 €             | B     | 1    | HC   |
| 4781 | 192,00 €             | B     | 1    | HC   |
| 4782 | 192,00 €             | B     | 1    | HC   |
| 4783 | 368,50 €             | B     | 1    | HC   |
| 4784 | 368,50 €             | B     | 1    | HC   |
| 4785 | 4,30 €               | C     | 10   | 104  |
| 4786 | 5,50 €               | C     | 10   | 102  |
| 4787 | 108,10 €             | B     | 1    | 170  |
| 4788 | 145,70 €             | B     | 1    | 170  |
| 4789 | 91,60 €              | B     | 1    | 170  |
| 4790 | 104,80 €             | B     | 1    | 170  |
| 4791 | 103,70 €             | B     | 1    | 170  |
| 4792 | 141,20 €             | B     | 1    | 170  |
| 4802 | 11,90 €              | C     | 1    | 94   |

| Code | Prix € HT<br>02/2020 | Prod. | U.E. | Page |
|------|----------------------|-------|------|------|
| 4805 | 14,30 €              | C     | 1    | 84   |
| 4807 | 15,30 €              | C     | 1    | 84   |
| 4810 | 52,20 €              | C     | 1    | HC   |
| 4816 | 50,10 €              | C     | 1    | HC   |
| 4836 | 15,50 €              | C     | 1    | 95   |
| 4837 | 67,10 €              | C     | 1    | HC   |
| 4843 | 15,30 €              | C     | 1    | 84   |
| 4845 | 30,40 €              | C     | 1    | 96   |
| 4850 | 13,30 €              | C     | 1    | HC   |
| 4852 | 20,90 €              | C     | 1    | 95   |
| 4853 | 21,10 €              | C     | 1    | HC   |
| 4854 | 4,30 €               | C     | 10   | 104  |
| 4855 | 9,70 €               | C     | 10   | 104  |
| 4856 | 8,00 €               | C     | 1    | 94   |
| 4857 | 5,80 €               | C     | 10   | 104  |
| 4869 | 86,30 €              | B     | 1    | HC   |
| 4870 | 12,20 €              | C     | 1    | 108  |
| 4872 | 7,60 €               | B     | 1    | 104  |
| 4873 | 16,30 €              | C     | 1    | 84   |
| 4874 | 5,50 €               | C     | 10   | 102  |
| 4875 | 11,70 €              | C     | 10   | 102  |
| 4877 | 8,80 €               | B     | 1    | 103  |
| 4880 | 10,80 €              | B     | 10   | 105  |
| 4881 | 13,60 €              | B     | 10   | 105  |
| 4882 | 12,30 €              | B     | 10   | 105  |
| 4883 | 13,60 €              | B     | 10   | 105  |
| 4884 | 9,70 €               | C     | 10   | 104  |
| 4885 | 11,70 €              | C     | 10   | 102  |
| 4887 | 7,60 €               | C     | 10   | 102  |
| 4890 | 12,00 €              | B     | 10   | 100  |
| 4891 | 13,70 €              | B     | 10   | 100  |
| 4892 | 14,70 €              | B     | 10   | 100  |
| 4893 | 9,70 €               | B     | 1    | 94   |
| 4894 | 13,60 €              | B     | 1    | 94   |
| 4895 | 12,80 €              | B     | 1    | 95   |
| 4896 | 16,30 €              | B     | 1    | 95   |
| 4897 | 15,50 €              | B     | 1    | 96   |
| 4898 | 18,40 €              | B     | 1    | 96   |
| 4899 | 11,90 €              | C     | 1    | 95   |
| 4902 | 14,70 €              | B     | 10   | 100  |
| 4908 | 28,00 €              | C     | 10   | HC   |
| 4933 | 39,10 €              | C     | 10   | HC   |
| 4960 | 19,40 €              | C     | 1    | HC   |
| 4963 | 29,10 €              | C     | 10   | HC   |
| 4964 | 61,50 €              | C     | 1    | HC   |
| 4965 | 82,10 €              | C     | 1    | HC   |
| 4970 | 15,30 €              | B     | 1    | 94   |
| 4971 | 15,30 €              | B     | 1    | 94   |
| 4972 | 21,70 €              | B     | 1    | 95   |
| 4973 | 21,70 €              | B     | 1    | 95   |
| 4974 | 34,20 €              | C     | 1    | HC   |
| 4988 | 37,70 €              | B     | 10   | HC   |
| 5033 | 85,20 €              | B     | 1    | 368  |
| 5034 | 85,20 €              | B     | 1    | 368  |
| 5035 | 23,80 €              | B     | 1    | 368  |
| 5036 | 23,80 €              | B     | 1    | 368  |
| 5046 | 221,10 €             | B     | 1    | 388  |
| 5047 | 221,10 €             | B     | 1    | 388  |
| 5052 | 48,00 €              | B     | 1    | HC   |
| 5058 | 83,60 €              | B     | 1    | 324  |
| 5070 | 184,60 €             | B     | 1    | 398  |
| 5072 | 223,80 €             | B     | 1    | 398  |
| 5076 | 38,80 €              | B     | 1    | 109  |
| 5077 | 38,80 €              | B     | 1    | 109  |
| 5089 | 468,20 €             | B     | 1    | HC   |
| 5090 | 468,20 €             | B     | 1    | HC   |
| 5091 | 468,20 €             | B     | 1    | HC   |
| 5096 | 70,40 €              | B     | 1    | HC   |
| 5097 | 70,40 €              | B     | 1    | HC   |
| 5099 | 70,40 €              | B     | 1    | HC   |
| 5127 | 137,70 €             | B     | 1    | 186  |

Ces prix sont valables en France métropolitaine et Dom-Tom.

NC : nous consulter - HC : hors catalogue

# LISTE DES CODES (5137 à 16354) - TARIFS 02/2020

| Code | Prix € HT 02/2020 | Prod. | U.E. | Page   |
|------|-------------------|-------|------|--------|
| 5137 | 204,70 €          | B     | 1    | 376    |
| 5138 | 187,80 €          | B     | 1    | 376    |
| 5139 | 246,10 €          | B     | 1    | 376    |
| 5140 | 225,90 €          | B     | 1    | 376    |
| 5141 | 181,60 €          | B     | 1    | 52     |
| 5142 | 181,60 €          | B     | 1    | 52     |
| 5153 | 166,30 €          | B     | 1    | HC     |
| 5175 | 46,90 €           | B     | 1    | HC     |
| 5180 | 38,80 €           | B     | 1    | 109    |
| 5181 | 38,80 €           | B     | 1    | 109    |
| 5182 | 38,80 €           | B     | 1    | 109    |
| 5183 | 38,80 €           | B     | 1    | 109    |
| 5184 | 38,80 €           | B     | 1    | 109    |
| 5185 | 38,80 €           | B     | 1    | 109    |
| 5188 | 46,90 €           | B     | 1    | HC     |
| 5195 | 46,90 €           | B     | 1    | HC     |
| 5196 | 46,90 €           | B     | 1    | HC     |
| 5204 | 16,30 €           | B     | 10   | 101    |
| 5205 | 16,30 €           | B     | 10   | 101    |
| 5212 | 103,70 €          | B     | 1    | 171    |
| 5214 | 103,70 €          | B     | 1    | 171    |
| 5216 | 96,00 €           | B     | 1    | 170    |
| 5219 | 96,00 €           | B     | 1    | 170    |
| 5222 | 77,50 €           | B     | 1    | 256    |
| 5223 | 73,40 €           | B     | 1    | 256    |
| 5238 | 16,30 €           | B     | 10   | 101    |
| 5239 | 16,30 €           | B     | 10   | 101    |
| 5242 | 40,80 €           | B     | 1    | 120    |
| 5243 | 40,80 €           | B     | 1    | 120    |
| 5244 | 40,80 €           | B     | 1    | 120    |
| 5254 | 137,70 €          | B     | 1    | HC     |
| 5262 | 40,80 €           | B     | 1    | 120    |
| 5263 | 40,80 €           | B     | 1    | 120    |
| 5269 | 282,50 €          | B     | 1    | 365    |
| 5270 | 109,10 €          | B     | 1    | 364    |
| 5278 | 136,70 €          | B     | 1    | HC     |
| 5292 | 518,20 €          | B     | 1    | HC     |
| 5293 | 527,30 €          | B     | 1    | HC     |
| 5294 | 518,20 €          | B     | 1    | HC     |
| 5296 | 518,20 €          | B     | 1    | HC     |
| 5297 | 527,30 €          | B     | 1    | HC     |
| 5298 | 518,20 €          | B     | 1    | HC     |
| 5299 | 527,30 €          | B     | 1    | HC     |
| 5310 | 37,70 €           | B     | 1    | HC     |
| 5311 | 37,70 €           | B     | 1    | HC     |
| 5313 | 79,10 €           | B     | 1    | 377    |
| 5326 | 386,60 €          | B     | 1    | 362    |
| 5331 | 21,40 €           | B     | 1    | HC     |
| 5332 | 20,40 €           | B     | 1    | 114    |
| 5333 | 20,40 €           | B     | 1    | 114    |
| 5334 | 19,40 €           | B     | 1    | 114    |
| 5337 | 94,90 €           | B     | 1    | 114    |
| 5358 | 729,30 €          | B     | 1    | HC     |
| 5359 | 816,00 €          | B     | 1    | HC     |
| 5360 | 824,20 €          | B     | 1    | HC     |
| 5361 | 729,30 €          | B     | 1    | HC     |
| 5362 | 816,00 €          | B     | 1    | HC     |
| 5363 | 824,20 €          | B     | 1    | HC     |
| 5364 | 19,40 €           | B     | 1    | 114    |
| 5365 | 94,90 €           | B     | 1    | 114    |
| 5370 | 386,00 €          | B     | 1    | 318    |
| 5371 | 386,00 €          | B     | 1    | 318    |
| 5372 | 489,00 €          | B     | 1    | 318    |
| 5373 | 489,00 €          | B     | 1    | 318    |
| 5376 | 406,00 €          | B     | 1    | 318    |
| 5377 | 513,00 €          | B     | 1    | 318    |
| 5380 | 70,40 €           | B     | 1    | 93/111 |
| 5381 | 70,40 €           | B     | 1    | 93/111 |
| 5382 | 90,80 €           | B     | 1    | 141    |
| 5383 | 90,80 €           | B     | 1    | 141    |
| 5384 | 90,80 €           | B     | 1    | 141    |

| Code  | Prix € HT 02/2020 | Prod. | U.E. | Page    |
|-------|-------------------|-------|------|---------|
| 5385  | 90,80 €           | B     | 1    | 141     |
| 5387  | 300,90 €          | B     | 1    | 141     |
| 5408  | 52,70 €           | B     | 1    | HC      |
| 5409  | 47,20 €           | B     | 1    | HC      |
| 5411  | 134,60 €          | B     | 1    | 172     |
| 5424  | 147,90 €          | B     | 1    | 172     |
| 5425  | 91,80 €           | B     | 1    | 172     |
| 5426  | 93,80 €           | B     | 1    | 172     |
| 5427  | 149,90 €          | B     | 1    | 172     |
| 5442  | 49,00 €           | B     | 1    | 111     |
| 5464  | 386,00 €          | B     | 1    | 318     |
| 5465  | 386,00 €          | B     | 1    | 318     |
| 5466  | 386,00 €          | B     | 1    | 318     |
| 5467  | 489,00 €          | B     | 1    | 318     |
| 5468  | 489,00 €          | B     | 1    | 318     |
| 5469  | 489,00 €          | B     | 1    | 318     |
| 5473  | 21,90 €           | B     | 1    | HC      |
| 5475  | 386,00 €          | B     | 1    | 318     |
| 5476  | 386,00 €          | B     | 1    | 318     |
| 5477  | 386,00 €          | B     | 1    | 318     |
| 5478  | 386,00 €          | B     | 1    | 318     |
| 5479  | 386,00 €          | B     | 1    | 318     |
| 5480  | 406,00 €          | B     | 1    | 318     |
| 5488  | 489,00 €          | B     | 1    | 318     |
| 5489  | 489,00 €          | B     | 1    | 318     |
| 5490  | 489,00 €          | B     | 1    | 318     |
| 5491  | 489,00 €          | B     | 1    | 318     |
| 5492  | 489,00 €          | B     | 1    | 318     |
| 5493  | 513,00 €          | B     | 1    | 318     |
| 5500  | 80,70 €           | B     | 1    | 385     |
| 5501  | 80,70 €           | B     | 1    | 385     |
| 5502  | 80,70 €           | B     | 1    | 385     |
| 5512  | 89,30 €           | B     | 1    | 385     |
| 5513  | 89,30 €           | B     | 1    | 385     |
| 5514  | 89,30 €           | B     | 1    | 385     |
| 5518  | 84,50 €           | B     | 1    | 384/385 |
| 5520  | 43,70 €           | B     | 1    | 385     |
| 5523  | 27,60 €           | B     | 1    | 385     |
| 5524  | 26,20 €           | B     | 1    | 385     |
| 5529  | 10,20 €           | B     | 1    | 385     |
| 5586  | 118,90 €          | B     | 1    | HC      |
| 5587  | 118,90 €          | B     | 1    | HC      |
| 5593  | 72,80 €           | B     | 1    | 386     |
| 5594  | 58,20 €           | B     | 1    | 386     |
| 5600  | 201,00 €          | B     | 1    | 387     |
| 5601  | 94,70 €           | B     | 1    | 387     |
| 5602  | 81,60 €           | B     | 1    | 387     |
| 5603  | 84,50 €           | B     | 1    | 387     |
| 5604  | 72,80 €           | B     | 1    | 387     |
| 5629  | 23,10 €           | B     | 1    | 385     |
| 5630  | 19,00 €           | B     | 1    | 385     |
| 5639  | 80,70 €           | B     | 1    | 384     |
| 5658  | 28,90 €           | B     | 1    | HC      |
| 5666  | 87,40 €           | B     | 1    | 387     |
| 5667  | 80,70 €           | B     | 1    | 385     |
| 5668  | 89,30 €           | B     | 1    | 385     |
| 5675  | 74,50 €           | B     | 1    | 384     |
| 5687  | 83,20 €           | B     | 1    | 386     |
| 5688  | 83,20 €           | B     | 1    | 386     |
| 5689  | 83,20 €           | B     | 1    | 386     |
| 5694  | 100,30 €          | B     | 1    | 387     |
| 5695  | 100,30 €          | B     | 1    | 387     |
| 5696  | 100,30 €          | B     | 1    | 387     |
| 5697  | 100,30 €          | B     | 1    | HC      |
| 10744 | 148,20 €          | B     | 1    | HC      |
| 11001 | 27,50 €           | B     | 1    | 68      |
| 11002 | 27,50 €           | B     | 1    | 68      |
| 11003 | 2,60 €            | B     | 1    | 69      |
| 11004 | 2,60 €            | B     | 1    | 69      |
| 11005 | 29,00 €           | B     | 1    | 69      |
| 11006 | 2,60 €            | B     | 1    | 69      |

| Code  | Prix € HT 02/2020 | Prod. | U.E. | Page    |
|-------|-------------------|-------|------|---------|
| 11007 | 2,60 €            | B     | 1    | 69      |
| 11008 | 3,60 €            | B     | 1    | 69      |
| 11009 | 3,60 €            | B     | 1    | 69      |
| 11010 | 3,60 €            | B     | 1    | 69      |
| 11011 | 3,60 €            | B     | 1    | 69      |
| 11012 | 3,60 €            | B     | 1    | 69      |
| 11013 | 3,60 €            | B     | 1    | 69      |
| 11020 | 18,00 €           | B     | 1    | HC      |
| 11021 | 18,00 €           | B     | 1    | HC      |
| 16100 | 14,00 €           | B     | 1    | 125     |
| 16101 | 14,00 €           | B     | 1    | 125     |
| 16113 | 35,90 €           | B     | 1    | 124/441 |
| 16114 | 35,90 €           | B     | 1    | 124/441 |
| 16120 | 126,40 €          | B     | 1    | HC      |
| 16121 | 126,40 €          | B     | 1    | HC      |
| 16122 | 126,40 €          | B     | 1    | HC      |
| 16123 | 71,00 €           | B     | 1    | 124/441 |
| 16124 | 71,00 €           | B     | 1    | 124/441 |
| 16130 | 173,70 €          | B     | 1    | HC      |
| 16131 | 173,70 €          | B     | 1    | HC      |
| 16132 | 173,70 €          | B     | 1    | HC      |
| 16133 | 105,30 €          | B     | 1    | 124/441 |
| 16134 | 105,30 €          | B     | 1    | 124/441 |
| 16301 | 20,10 €           | B     | 1    | HC      |
| 16302 | 20,10 €           | B     | 1    | HC      |
| 16303 | 20,10 €           | B     | 1    | HC      |
| 16304 | 20,10 €           | B     | 1    | HC      |
| 16305 | 20,10 €           | B     | 1    | HC      |
| 16306 | 20,10 €           | B     | 1    | HC      |
| 16307 | 48,50 €           | B     | 1    | HC      |
| 16308 | 48,50 €           | B     | 1    | HC      |
| 16309 | 48,50 €           | B     | 1    | HC      |
| 16310 | 14,20 €           | B     | 1    | HC      |
| 16312 | 14,20 €           | B     | 1    | HC      |
| 16313 | 78,00 €           | B     | 1    | HC      |
| 16314 | 78,00 €           | B     | 1    | HC      |
| 16315 | 78,00 €           | B     | 1    | HC      |
| 16316 | 65,00 €           | B     | 1    | HC      |
| 16317 | 65,00 €           | B     | 1    | HC      |
| 16318 | 65,00 €           | B     | 1    | HC      |
| 16319 | 94,60 €           | B     | 1    | HC      |
| 16321 | 94,60 €           | B     | 1    | HC      |
| 16322 | 94,60 €           | B     | 1    | HC      |
| 16323 | 94,60 €           | B     | 1    | HC      |
| 16324 | 94,60 €           | B     | 1    | HC      |
| 16325 | 3,50 €            | B     | 1    | HC      |
| 16326 | 3,50 €            | B     | 1    | HC      |
| 16327 | 3,50 €            | B     | 1    | HC      |
| 16330 | 14,20 €           | B     | 1    | HC      |
| 16331 | 122,90 €          | B     | 1    | HC      |
| 16332 | 122,90 €          | B     | 1    | HC      |
| 16333 | 122,90 €          | B     | 1    | HC      |
| 16335 | 23,70 €           | B     | 1    | HC      |
| 16336 | 12,10 €           | B     | 1    | HC      |
| 16337 | 6,20 €            | B     | 1    | HC      |
| 16338 | 7,70 €            | B     | 1    | HC      |
| 16340 | 17,10 €           | B     | 1    | 124/441 |
| 16341 | 17,10 €           | B     | 1    | 124/441 |
| 16342 | 10,60 €           | B     | 1    | 124/441 |
| 16343 | 10,60 €           | B     | 1    | 124/441 |
| 16344 | 9,00 €            | B     | 1    | 124/441 |
| 16345 | 9,00 €            | B     | 1    | 124/441 |
| 16346 | 14,70 €           | B     | 1    | 124/441 |
| 16347 | 14,70 €           | B     | 1    | 124/441 |
| 16348 | 14,70 €           | B     | 1    | 124/441 |
| 16349 | 14,70 €           | B     | 1    | 124/441 |
| 16350 | 31,00 €           | B     | 1    | 124/441 |
| 16351 | 31,00 €           | B     | 1    | 124/441 |
| 16352 | 31,00 €           | B     | 1    | 124/441 |
| 16353 | 31,00 €           | B     | 1    | 124/441 |
| 16354 | 1,60 €            | B     | 1    | 124/441 |

Ces prix sont valables en France métropolitaine et Dom-Tom.

# LISTE DES CODES (16355 à 50310) - TARIFS 02/2020

| Code  | Prix € HT<br>02/2020 | Prod. | U.E. | Page    |
|-------|----------------------|-------|------|---------|
| 16355 | 1,60 €               | B     | 1    | 124/441 |
| 16356 | 7,30 €               | B     | 1    | 124/441 |
| 16357 | 48,10 €              | B     | 1    | 124/441 |
| 16358 | 48,10 €              | B     | 1    | 124/441 |
| 16359 | 48,10 €              | B     | 1    | 124/441 |
| 16360 | 48,10 €              | B     | 1    | 124/441 |
| 20010 | 15,30 €              | A     | 1    | 20      |
| 20011 | 17,30 €              | A     | 1    | 20      |
| 20012 | 24,50 €              | A     | 1    | 21      |
| 20013 | 11,20 €              | A     | 1    | 21      |
| 20014 | 6,10 €               | A     | 1    | 20      |
| 20015 | 6,50 €               | A     | 1    | 22      |
| 20016 | 27,50 €              | A     | 10   | 29      |
| 20017 | 27,50 €              | A     | 10   | 29      |
| 20018 | 14,00 €              | A     | 10   | 32      |
| 20019 | 16,00 €              | A     | 10   | 29      |
| 20020 | 23,20 €              | A     | 1    | 24      |
| 20021 | 25,00 €              | A     | 1    | 25      |
| 20022 | 20,40 €              | A     | 1    | 24      |
| 20023 | 15,70 €              | A     | 1    | 24      |
| 20030 | 6,10 €               | A     | 10   | 19      |
| 20031 | 6,10 €               | A     | 10   | 19      |
| 20032 | 7,10 €               | A     | 10   | 20      |
| 20033 | 7,10 €               | A     | 10   | 20      |
| 20034 | 6,10 €               | A     | 10   | 23      |
| 20035 | 6,10 €               | A     | 10   | 23      |
| 20050 | 9,20 €               | A     | 1    | 17      |
| 20051 | 9,20 €               | A     | 1    | 17      |
| 50011 | 36,30 €              | B     | 1    | 291     |
| 50012 | 36,30 €              | B     | 1    | 291     |
| 50033 | 18,40 €              | B     | 1    | HC      |
| 50039 | 33,00 €              | B     | 1    | 50/79   |
| 50040 | 33,00 €              | B     | 1    | 50/79   |
| 50048 | 462,10 €             | B     | 1    | 238     |
| 50058 | 14,30 €              | B     | 1    | HC      |
| 50059 | 8,70 €               | B     | 1    | 50/79   |
| 50060 | 163,40 €             | B     | 1    | 224/432 |
| 50061 | 8,70 €               | B     | 1    | 50/79   |
| 50072 | 82,60 €              | B     | 1    | HC      |
| 50076 | 21,90 €              | B     | 1    | 304/312 |
| 50077 | 11,20 €              | B     | 1    | HC      |
| 50078 | 5,10 €               | B     | 1    | HC      |
| 50081 | 33,20 €              | B     | 1    | 54      |
| 50082 | 37,40 €              | B     | 1    | 54      |
| 50087 | 155,00 €             | B     | 1    | 61      |
| 50097 | 67,00 €              | B     | 1    | 322     |
| 50100 | 67,00 €              | B     | 1    | 322     |
| 50104 | 33,20 €              | B     | 1    | 54      |
| 50105 | 37,40 €              | B     | 1    | 54      |
| 50108 | 193,80 €             | B     | 1    | 134     |
| 50109 | 214,20 €             | B     | 1    | 134     |
| 50114 | 36,70 €              | B     | 1    | HC      |
| 50115 | 152,00 €             | B     | 1    | 243     |
| 50116 | 134,60 €             | B     | 1    | HC      |
| 50118 | 561,00 €             | B     | 1    | HC      |
| 50119 | 765,00 €             | B     | 1    | HC      |
| 50120 | 101,00 €             | B     | 1    | 360     |
| 50121 | 104,00 €             | B     | 1    | 360     |
| 50122 | 132,60 €             | B     | 1    | 360     |
| 50123 | 93,80 €              | B     | 1    | 58      |
| 50124 | 143,80 €             | B     | 1    | 58      |
| 50125 | 163,20 €             | B     | 1    | 59      |
| 50130 | 64,30 €              | B     | 1    | 88      |
| 50131 | 64,30 €              | B     | 1    | 88      |
| 50132 | 64,30 €              | B     | 1    | 88      |
| 50133 | 64,30 €              | B     | 1    | 88      |
| 50134 | 64,30 €              | B     | 1    | 88      |
| 50135 | 64,30 €              | B     | 1    | 88      |
| 50136 | 64,30 €              | B     | 1    | 88      |
| 50137 | 64,30 €              | B     | 1    | 88      |
| 50138 | 69,60 €              | B     | 1    | 89      |

| Code  | Prix € HT<br>02/2020 | Prod. | U.E. | Page    |
|-------|----------------------|-------|------|---------|
| 50139 | 69,60 €              | B     | 1    | 89      |
| 50140 | 69,60 €              | B     | 1    | 89      |
| 50141 | 69,60 €              | B     | 1    | 89      |
| 50149 | 21,90 €              | B     | 1    | 312/314 |
| 50150 | 64,90 €              | B     | 1    | 88      |
| 50151 | 64,90 €              | B     | 1    | 88      |
| 50152 | 64,90 €              | B     | 1    | 88      |
| 50153 | 64,90 €              | B     | 1    | 88      |
| 50154 | 70,30 €              | B     | 1    | 78/89   |
| 50155 | 70,30 €              | B     | 1    | 78/89   |
| 50156 | 70,30 €              | B     | 1    | 78/89   |
| 50157 | 70,30 €              | B     | 1    | 78/89   |
| 50158 | 259,10 €             | B     | 1    | HC      |
| 50159 | 259,10 €             | B     | 1    | HC      |
| 50160 | 136,70 €             | B     | 1    | 241/275 |
| 50161 | 152,00 €             | B     | 1    | 240     |
| 50162 | 102,00 €             | B     | 1    | 239     |
| 50163 | 140,80 €             | B     | 1    | 243     |
| 50164 | 140,80 €             | B     | 1    | 240     |
| 50165 | 142,80 €             | B     | 1    | 136     |
| 50166 | 142,80 €             | B     | 1    | 136     |
| 50167 | 142,80 €             | B     | 1    | 136     |
| 50168 | 58,10 €              | B     | 1    | HC      |
| 50169 | 58,10 €              | B     | 1    | HC      |
| 50170 | 80,60 €              | B     | 1    | 140     |
| 50171 | 142,80 €             | B     | 1    | 136     |
| 50172 | 199,90 €             | B     | 1    | 127     |
| 50173 | 199,90 €             | B     | 1    | 127     |
| 50174 | 199,90 €             | B     | 1    | 127     |
| 50175 | 199,90 €             | B     | 1    | 127     |
| 50176 | 199,90 €             | B     | 1    | 127     |
| 50177 | 199,90 €             | B     | 1    | 127     |
| 50178 | 199,90 €             | B     | 1    | 127     |
| 50179 | 199,90 €             | B     | 1    | 127     |
| 50181 | 193,80 €             | B     | 1    | 61      |
| 50182 | 142,80 €             | B     | 1    | 137     |
| 50183 | 142,80 €             | B     | 1    | 137     |
| 50184 | 142,80 €             | B     | 1    | 137     |
| 50185 | 142,80 €             | B     | 1    | 137     |
| 50186 | 80,60 €              | B     | 1    | 140     |
| 50187 | 199,90 €             | B     | 1    | 126     |
| 50188 | 199,90 €             | B     | 1    | 126     |
| 50189 | 199,90 €             | B     | 1    | 126     |
| 50190 | 199,90 €             | B     | 1    | 126     |
| 50191 | 143,80 €             | B     | 1    | 58      |
| 50192 | 163,20 €             | B     | 1    | 59      |
| 50193 | 180,50 €             | B     | 1    | 59      |
| 50194 | 180,50 €             | B     | 1    | 59      |
| 50195 | 142,80 €             | B     | 1    | 137     |
| 50196 | 142,80 €             | B     | 1    | 137     |
| 50197 | 244,80 €             | B     | 1    | 134     |
| 50198 | 142,80 €             | B     | 1    | 137     |
| 50199 | 142,80 €             | B     | 1    | 137     |
| 50205 | 52,00 €              | B     | 1    | 324     |
| 50206 | 52,00 €              | B     | 1    | 324     |
| 50207 | 36,70 €              | B     | 1    | 83      |
| 50208 | 37,70 €              | B     | 1    | 83      |
| 50209 | 37,70 €              | B     | 1    | 83      |
| 50210 | 36,70 €              | B     | 1    | 83      |
| 50211 | 41,80 €              | B     | 1    | 80      |
| 50212 | 41,80 €              | B     | 1    | 80      |
| 50213 | 33,70 €              | B     | 1    | 85      |
| 50214 | 34,70 €              | B     | 1    | 85      |
| 50215 | 33,70 €              | B     | 1    | 85      |
| 50216 | 34,70 €              | B     | 1    | 85      |
| 50217 | 185,60 €             | B     | 1    | 342     |
| 50218 | 185,60 €             | B     | 1    | 342     |
| 50219 | 47,90 €              | B     | 1    | HC      |
| 50220 | 85,70 €              | B     | 1    | 48      |
| 50221 | 92,80 €              | B     | 1    | 48      |
| 50222 | 97,90 €              | B     | 1    | 48      |

| Code  | Prix € HT<br>02/2020 | Prod. | U.E. | Page    |
|-------|----------------------|-------|------|---------|
| 50224 | 236,60 €             | B     | 1    | 274     |
| 50225 | 161,20 €             | B     | 1    | 274     |
| 50226 | 153,00 €             | B     | 1    | HC      |
| 50227 | 39,80 €              | B     | 1    | 80      |
| 50229 | 142,80 €             | B     | 1    | HC      |
| 50230 | 28,60 €              | B     | 1    | 314/322 |
| 50232 | 237,70 €             | B     | 1    | 239     |
| 50234 | 47,90 €              | B     | 1    | 118     |
| 50235 | 47,90 €              | B     | 1    | 118     |
| 50236 | 47,90 €              | B     | 1    | 118     |
| 50237 | 47,90 €              | B     | 1    | 118     |
| 50238 | 14,30 €              | B     | 1    | 118     |
| 50242 | 199,90 €             | B     | 1    | 310     |
| 50243 | 199,90 €             | B     | 1    | 310     |
| 50244 | 211,10 €             | B     | 1    | HC      |
| 50245 | 188,70 €             | B     | 1    | HC      |
| 50246 | 21,40 €              | B     | 1    | HC      |
| 50247 | 199,90 €             | B     | 1    | 310     |
| 50248 | 199,90 €             | B     | 1    | 310     |
| 50251 | 119,30 €             | B     | 1    | 258     |
| 50252 | 128,50 €             | B     | 1    | 258     |
| 50253 | 145,90 €             | B     | 1    | 259     |
| 50254 | 158,10 €             | B     | 1    | 259     |
| 50255 | 114,20 €             | B     | 1    | 258     |
| 50256 | 123,40 €             | B     | 1    | 258     |
| 50257 | 147,90 €             | B     | 1    | 259     |
| 50258 | 160,10 €             | B     | 1    | 259     |
| 50260 | 46,80 €              | B     | 1    | HC      |
| 50261 | 64,30 €              | B     | 1    | 119     |
| 50262 | 64,30 €              | B     | 1    | 119     |
| 50263 | 57,10 €              | B     | 1    | 119     |
| 50264 | 57,10 €              | B     | 1    | 119     |
| 50265 | 79,60 €              | B     | 1    | 119     |
| 50266 | 79,60 €              | B     | 1    | 119     |
| 50267 | 70,40 €              | B     | 1    | 119     |
| 50268 | 70,40 €              | B     | 1    | 119     |
| 50269 | 8,20 €               | B     | 1    | HC      |
| 50270 | 6,10 €               | B     | 1    | HC      |
| 50271 | 46,80 €              | B     | 1    | HC      |
| 50272 | 372,30 €             | B     | 1    | 390     |
| 50273 | 284,60 €             | B     | 1    | 391     |
| 50274 | 294,80 €             | B     | 1    | 391     |
| 50275 | 157,00 €             | B     | 1    | 244     |
| 50276 | 144,00 €             | B     | 1    | 244     |
| 50277 | 102,00 €             | B     | 1    | HC      |
| 50278 | 262,10 €             | B     | 1    | 344/390 |
| 50279 | 199,90 €             | B     | 1    | 310     |
| 50280 | 199,90 €             | B     | 1    | 310     |
| 50281 | 199,90 €             | B     | 1    | 310     |
| 50282 | 199,90 €             | B     | 1    | 310     |
| 50283 | 39,80 €              | B     | 1    | 390     |
| 50284 | 39,80 €              | B     | 1    | 391     |
| 50285 | 211,10 €             | B     | 1    | 374     |
| 50286 | 211,10 €             | B     | 1    | 374     |
| 50287 | 188,70 €             | B     | 1    | 374     |
| 50288 | 188,70 €             | B     | 1    | 374     |
| 50289 | 114,20 €             | B     | 1    | 374     |
| 50292 | 206,00 €             | B     | 1    | 354     |
| 50295 | 592,60 €             | B     | 1    | 417     |
| 50296 | 830,30 €             | B     | 1    | 392     |
| 50298 | 636,50 €             | B     | 1    | 393     |
| 50299 | 51,00 €              | B     | 1    | 393     |
| 50300 | 452,90 €             | B     | 1    | 394     |
| 50301 | 51,00 €              | B     | 1    | HC      |
| 50302 | 199,90 €             | B     | 1    | 311     |
| 50303 | 199,90 €             | B     | 1    | 311     |
| 50304 | 199,90 €             | B     | 1    | 311     |
| 50305 | 199,90 €             | B     | 1    | 311     |
| 50307 | 72,40 €              | B     | 1    | HC      |
| 50309 | 130,60 €             | B     | 1    | 272/332 |
| 50310 | 550,80 €             | B     | 1    | HC      |

Ces prix sont valables en France métropolitaine et Dom-Tom.

NC : nous consulter - HC : hors catalogue

# LISTE DES CODES (50311 à 50568) - TARIFS 02/2020

| Code  | Prix € HT<br>02/2020 | Prod. | U.E. | Page    |
|-------|----------------------|-------|------|---------|
| 50311 | 65,90 €              | B     | 1    | HC      |
| 50317 | 51,00 €              | B     | 1    | HC      |
| 50319 | 84,70 €              | B     | 1    | 270/333 |
| 50320 | 93,80 €              | B     | 1    | 241/275 |
| 50321 | 47,90 €              | B     | 1    | 270/333 |
| 50322 | 199,90 €             | B     | 1    | 127     |
| 50323 | 199,90 €             | B     | 1    | 127     |
| 50324 | 199,90 €             | B     | 1    | 127     |
| 50325 | 199,90 €             | B     | 1    | 127     |
| 50326 | 199,90 €             | B     | 1    | 127     |
| 50327 | 199,90 €             | B     | 1    | 127     |
| 50328 | 199,90 €             | B     | 1    | 127     |
| 50329 | 199,90 €             | B     | 1    | 127     |
| 50330 | 14,30 €              | B     | 1    | 51/78   |
| 50331 | 20,40 €              | B     | 1    | 51/78   |
| 50332 | 14,30 €              | B     | 1    | 51/78   |
| 50333 | 20,40 €              | B     | 1    | 51/78   |
| 50334 | 44,70 €              | B     | 1    | 51      |
| 50335 | 50,90 €              | B     | 1    | 51      |
| 50338 | 112,20 €             | B     | 1    | HC      |
| 50346 | 386,60 €             | B     | 1    | HC      |
| 50351 | 149,90 €             | B     | 1    | 316     |
| 50352 | 149,90 €             | B     | 1    | 316     |
| 50355 | 40,80 €              | B     | 1    | HC      |
| 50359 | 17,50 €              | B     | 1    | 54/110  |
| 50360 | 36,70 €              | B     | 1    | 46      |
| 50361 | 46,90 €              | B     | 1    | 46      |
| 50362 | 57,10 €              | B     | 1    | 46      |
| 50363 | 62,00 €              | B     | 1    | 46      |
| 50364 | 199,90 €             | B     | 1    | 126     |
| 50365 | 199,90 €             | B     | 1    | 126     |
| 50366 | 199,90 €             | B     | 1    | 126     |
| 50367 | 199,90 €             | B     | 1    | 126     |
| 50368 | 237,70 €             | B     | 1    | HC      |
| 50369 | 237,70 €             | B     | 1    | HC      |
| 50370 | 237,70 €             | B     | 1    | HC      |
| 50371 | 289,70 €             | B     | 1    | 276     |
| 50372 | 289,70 €             | B     | 1    | 276     |
| 50373 | 293,80 €             | B     | 1    | 276     |
| 50374 | 293,80 €             | B     | 1    | 276     |
| 50377 | 41,60 €              | B     | 1    | 46      |
| 50378 | 112,20 €             | B     | 1    | 277     |
| 50379 | 66,70 €              | B     | 1    | 54      |
| 50380 | 80,00 €              | B     | 1    | 54      |
| 50381 | 64,30 €              | B     | 1    | 119     |
| 50382 | 57,10 €              | B     | 1    | 119     |
| 50383 | 79,60 €              | B     | 1    | 119     |
| 50384 | 70,40 €              | B     | 1    | 119     |
| 50385 | 31,60 €              | B     | 1    | 312     |
| 50386 | 44,90 €              | B     | 1    | 312     |
| 50387 | 59,20 €              | B     | 1    | 312     |
| 50388 | 90,80 €              | B     | 1    | 312     |
| 50389 | 31,60 €              | B     | 1    | 312     |
| 50390 | 44,90 €              | B     | 1    | 312     |
| 50391 | 59,20 €              | B     | 1    | 312     |
| 50392 | 90,80 €              | B     | 1    | 312     |
| 50393 | 24,50 €              | B     | 1    | 315     |
| 50396 | 35,70 €              | B     | 1    | HC      |
| 50397 | 35,70 €              | B     | 1    | HC      |
| 50398 | 60,20 €              | B     | 1    | 313     |
| 50399 | 77,50 €              | B     | 1    | 313     |
| 50403 | 25,50 €              | B     | 1    | 86      |
| 50404 | 25,50 €              | B     | 1    | 86      |
| 50405 | 46,90 €              | B     | 1    | HC      |
| 50406 | 71,40 €              | B     | 1    | HC      |
| 50407 | 145,90 €             | B     | 1    | HC      |
| 50408 | 230,50 €             | B     | 1    | HC      |
| 50409 | 304,00 €             | B     | 1    | HC      |
| 50410 | 35,40 €              | B     | 1    | 73      |
| 50411 | 35,40 €              | B     | 1    | 73      |
| 50412 | 40,80 €              | B     | 1    | 120     |

| Code  | Prix € HT<br>02/2020 | Prod. | U.E. | Page    |
|-------|----------------------|-------|------|---------|
| 50413 | 40,80 €              | B     | 1    | 120     |
| 50414 | 40,80 €              | B     | 1    | 120     |
| 50415 | 40,80 €              | B     | 1    | 120     |
| 50416 | 15,30 €              | B     | 1    | 337     |
| 50417 | 41,60 €              | B     | 1    | 46      |
| 50418 | 46,90 €              | B     | 1    | 46      |
| 50419 | 57,10 €              | B     | 1    | 46      |
| 50420 | 62,00 €              | B     | 1    | 46      |
| 50421 | 26,00 €              | B     | 1    | 87      |
| 50422 | 26,00 €              | B     | 1    | 87      |
| 50425 | 34,70 €              | B     | 1    | 180     |
| 50426 | 25,50 €              | B     | 1    | 180     |
| 50429 | 47,90 €              | B     | 1    | 266     |
| 50430 | 70,20 €              | B     | 1    | 266     |
| 50431 | 18,10 €              | B     | 1    | 92/110  |
| 50432 | 18,10 €              | B     | 1    | 92/110  |
| 50435 | 55,10 €              | B     | 1    | 266     |
| 50436 | 63,20 €              | B     | 1    | 266     |
| 50437 | 74,50 €              | B     | 1    | 266     |
| 50438 | 83,60 €              | B     | 1    | 266     |
| 50439 | 78,50 €              | B     | 1    | 139     |
| 50440 | 78,50 €              | B     | 1    | 139     |
| 50441 | 132,60 €             | B     | 1    | HC      |
| 50442 | 173,40 €             | B     | 1    | HC      |
| 50443 | 63,20 €              | B     | 1    | 58/90   |
| 50444 | 50,30 €              | B     | 1    | 49      |
| 50445 | 77,50 €              | B     | 1    | 49      |
| 50446 | 116,30 €             | B     | 1    | 49      |
| 50447 | 232,60 €             | B     | 1    | 363     |
| 50448 | 122,40 €             | B     | 1    | 277     |
| 50449 | 12,20 €              | B     | 1    | 281     |
| 50450 | 12,20 €              | B     | 1    | 281     |
| 50451 | 27,30 €              | B     | 1    | 263/314 |
| 50452 | 251,90 €             | B     | 1    | HC      |
| 50453 | 63,20 €              | B     | 1    | 58/90   |
| 50454 | 36,70 €              | B     | 1    | 46      |
| 50455 | 49,00 €              | B     | 1    | HC      |
| 50457 | 66,30 €              | B     | 1    | HC      |
| 50459 | 17,50 €              | B     | 1    | 54/110  |
| 50460 | 46,90 €              | B     | 1    | HC      |
| 50461 | 71,40 €              | B     | 1    | HC      |
| 50462 | 145,90 €             | B     | 1    | HC      |
| 50463 | 230,50 €             | B     | 1    | HC      |
| 50465 | 78,50 €              | B     | 1    | 139     |
| 50466 | 78,50 €              | B     | 1    | 139     |
| 50467 | 78,50 €              | B     | 1    | 138     |
| 50468 | 78,50 €              | B     | 1    | 138     |
| 50470 | 176,50 €             | B     | 1    | 62      |
| 50471 | 176,50 €             | B     | 1    | 62      |
| 50472 | 176,50 €             | B     | 1    | 62      |
| 50473 | 176,50 €             | B     | 1    | 62      |
| 50474 | 330,50 €             | B     | 1    | 62      |
| 50475 | 330,50 €             | B     | 1    | 62      |
| 50476 | 330,50 €             | B     | 1    | 62      |
| 50477 | 330,50 €             | B     | 1    | 62      |
| 50478 | 18,10 €              | B     | 1    | 92/110  |
| 50479 | 18,10 €              | B     | 1    | 92/110  |
| 50480 | 149,90 €             | B     | 1    | 63      |
| 50481 | 149,90 €             | B     | 1    | 63      |
| 50482 | 91,80 €              | B     | 1    | HC      |
| 50483 | 166,30 €             | B     | 1    | HC      |
| 50484 | 196,90 €             | B     | 1    | HC      |
| 50485 | 315,20 €             | B     | 1    | HC      |
| 50486 | 414,10 €             | B     | 1    | HC      |
| 50487 | 21,90 €              | B     | 1    | 304     |
| 50488 | 27,30 €              | B     | 1    | 304     |
| 50489 | 9,90 €               | B     | 1    | 304     |
| 50491 | 36,70 €              | B     | 1    | HC      |
| 50493 | 31,60 €              | B     | 1    | 312     |
| 50494 | 44,90 €              | B     | 1    | 312     |
| 50495 | 59,20 €              | B     | 1    | 312     |

| Code  | Prix € HT<br>02/2020 | Prod. | U.E. | Page |
|-------|----------------------|-------|------|------|
| 50496 | 90,80 €              | B     | 1    | 312  |
| 50497 | 24,50 €              | B     | 1    | 315  |
| 50498 | 24,50 €              | B     | 1    | 315  |
| 50499 | 24,50 €              | B     | 1    | 315  |
| 50500 | 38,80 €              | B     | 1    | 315  |
| 50501 | 38,80 €              | B     | 1    | 315  |
| 50502 | 38,80 €              | B     | 1    | 315  |
| 50503 | 38,80 €              | B     | 1    | 315  |
| 50504 | 31,60 €              | B     | 1    | 312  |
| 50505 | 44,90 €              | B     | 1    | 312  |
| 50506 | 59,20 €              | B     | 1    | 312  |
| 50507 | 90,80 €              | B     | 1    | 312  |
| 50508 | 274,40 €             | B     | 1    | 291  |
| 50509 | 274,40 €             | B     | 1    | 291  |
| 50510 | 56,10 €              | B     | 1    | 264  |
| 50511 | 70,40 €              | B     | 1    | 264  |
| 50512 | 61,20 €              | B     | 1    | 264  |
| 50513 | 76,50 €              | B     | 1    | 264  |
| 50514 | 66,30 €              | B     | 1    | 264  |
| 50515 | 85,70 €              | B     | 1    | 264  |
| 50516 | 19,40 €              | B     | 1    | 72   |
| 50517 | 19,40 €              | B     | 1    | 72   |
| 50518 | 15,10 €              | B     | 1    | 79   |
| 50519 | 15,10 €              | B     | 1    | 79   |
| 50520 | 59,20 €              | B     | 1    | 265  |
| 50521 | 72,40 €              | B     | 1    | 265  |
| 50522 | 63,20 €              | B     | 1    | 265  |
| 50523 | 78,50 €              | B     | 1    | 265  |
| 50524 | 68,30 €              | B     | 1    | 265  |
| 50525 | 87,70 €              | B     | 1    | 265  |
| 50526 | 175,40 €             | B     | 1    | HC   |
| 50527 | 175,40 €             | B     | 1    | 347  |
| 50530 | 196,90 €             | B     | 1    | HC   |
| 50531 | 196,90 €             | B     | 1    | HC   |
| 50532 | 196,90 €             | B     | 1    | HC   |
| 50533 | 196,90 €             | B     | 1    | HC   |
| 50534 | 15,30 €              | B     | 1    | 91   |
| 50535 | 15,30 €              | B     | 1    | 91   |
| 50536 | 19,40 €              | B     | 1    | 91   |
| 50537 | 19,40 €              | B     | 1    | 91   |
| 50538 | 22,40 €              | B     | 1    | 76   |
| 50539 | 22,40 €              | B     | 1    | 76   |
| 50540 | 23,50 €              | B     | 1    | 76   |
| 50541 | 23,50 €              | B     | 1    | 76   |
| 50542 | 221,30 €             | B     | 1    | 350  |
| 50543 | 221,30 €             | B     | 1    | 350  |
| 50544 | 119,30 €             | B     | 1    | 251  |
| 50545 | 171,40 €             | B     | 1    | 235  |
| 50546 | 188,70 €             | B     | 1    | 235  |
| 50547 | 188,70 €             | B     | 1    | 235  |
| 50548 | 151,00 €             | B     | 1    | 234  |
| 50549 | 165,20 €             | B     | 1    | 234  |
| 50550 | 143,80 €             | B     | 1    | 236  |
| 50551 | 143,80 €             | B     | 1    | 236  |
| 50552 | 153,00 €             | B     | 1    | 236  |
| 50553 | 153,00 €             | B     | 1    | 236  |
| 50554 | 143,80 €             | B     | 1    | 237  |
| 50555 | 143,80 €             | B     | 1    | 237  |
| 50556 | 151,00 €             | B     | 1    | 237  |
| 50557 | 151,00 €             | B     | 1    | 237  |
| 50558 | 152,00 €             | B     | 1    | 243  |
| 50559 | 134,60 €             | B     | 1    | HC   |
| 50560 | 165,20 €             | B     | 1    | 234  |
| 50561 | 133,60 €             | B     | 1    | 399  |
| 50562 | 175,40 €             | B     | 1    | 399  |
| 50563 | 206,00 €             | B     | 1    | 288  |
| 50564 | 206,00 €             | B     | 1    | 288  |
| 50565 | 238,70 €             | B     | 1    | 288  |
| 50566 | 238,70 €             | B     | 1    | 288  |
| 50567 | 125,50 €             | B     | 1    | 399  |
| 50568 | 238,70 €             | B     | 1    | 289  |

Ces prix sont valables en France métropolitaine et Dom-Tom.

# LISTE DES CODES (50569 à 50793) - TARIFS 02/2020

| Code  | Prix € HT<br>02/2020 | Prod. | U.E. | Page    |
|-------|----------------------|-------|------|---------|
| 50569 | 238,70 €             | B     | 1    | 289     |
| 50570 | 168,30 €             | B     | 1    | 128     |
| 50571 | 168,30 €             | B     | 1    | 128     |
| 50572 | 168,30 €             | B     | 1    | 128     |
| 50573 | 168,30 €             | B     | 1    | 128     |
| 50574 | 168,30 €             | B     | 1    | 128     |
| 50575 | 168,30 €             | B     | 1    | 128     |
| 50576 | 168,30 €             | B     | 1    | 128     |
| 50577 | 168,30 €             | B     | 1    | 128     |
| 50578 | 168,30 €             | B     | 1    | 129     |
| 50579 | 168,30 €             | B     | 1    | 129     |
| 50580 | 168,30 €             | B     | 1    | 129     |
| 50581 | 168,30 €             | B     | 1    | 129     |
| 50582 | 168,30 €             | B     | 1    | 129     |
| 50583 | 168,30 €             | B     | 1    | 129     |
| 50584 | 168,30 €             | B     | 1    | 129     |
| 50585 | 168,30 €             | B     | 1    | 129     |
| 50586 | 168,30 €             | B     | 1    | 129     |
| 50587 | 168,30 €             | B     | 1    | 129     |
| 50588 | 168,30 €             | B     | 1    | 129     |
| 50589 | 168,30 €             | B     | 1    | 129     |
| 50590 | 168,30 €             | B     | 1    | 129     |
| 50591 | 168,30 €             | B     | 1    | 129     |
| 50592 | 168,30 €             | B     | 1    | 129     |
| 50593 | 168,30 €             | B     | 1    | 129     |
| 50594 | 27,30 €              | B     | 1    | 263/304 |
| 50598 | 82,60 €              | B     | 1    | 112     |
| 50599 | 22,40 €              | B     | 1    | 112     |
| 50600 | 39,80 €              | B     | 1    | 52/91   |
| 50601 | 39,80 €              | B     | 1    | 52/91   |
| 50602 | 66,30 €              | B     | 1    | 52      |
| 50603 | 66,30 €              | B     | 1    | 52      |
| 50606 | 238,70 €             | B     | 1    | 289     |
| 50607 | 238,70 €             | B     | 1    | 289     |
| 50608 | 238,70 €             | B     | 1    | 289     |
| 50609 | 238,70 €             | B     | 1    | 289     |
| 50610 | 17,30 €              | B     | 1    | 112     |
| 50611 | 197,90 €             | B     | 1    | 375     |
| 50612 | 209,10 €             | B     | 1    | 375     |
| 50613 | 209,10 €             | B     | 1    | 375     |
| 50614 | 328,40 €             | B     | 1    | 351/396 |
| 50615 | 5,10 €               | B     | 1    | 112     |
| 50618 | 218,30 €             | B     | 1    | 344     |
| 50619 | 13,30 €              | B     | 1    | 87/110  |
| 50620 | 13,30 €              | B     | 1    | 87/110  |
| 50621 | 13,30 €              | B     | 1    | 87/110  |
| 50622 | 13,30 €              | B     | 1    | 87/110  |
| 50623 | 80,60 €              | B     | 1    | 113/187 |
| 50624 | 30,60 €              | B     | 1    | 113/187 |
| 50625 | 34,70 €              | B     | 1    | 180     |
| 50626 | 25,50 €              | B     | 1    | 180     |
| 50627 | 34,70 €              | B     | 1    | 180     |
| 50628 | 34,70 €              | B     | 1    | 180     |
| 50629 | 25,50 €              | B     | 1    | 180     |
| 50630 | 25,50 €              | B     | 1    | 180     |
| 50631 | 50,00 €              | B     | 1    | 67/90   |
| 50632 | 50,00 €              | B     | 1    | 67/90   |
| 50633 | 53,00 €              | B     | 1    | 67/90   |
| 50634 | 53,00 €              | B     | 1    | 67/90   |
| 50635 | 46,90 €              | B     | 1    | 77      |
| 50636 | 46,90 €              | B     | 1    | 77      |
| 50637 | 46,90 €              | B     | 1    | 77      |
| 50638 | 46,90 €              | B     | 1    | 77      |
| 50639 | 8,20 €               | B     | 1    | 112     |
| 50640 | 415,10 €             | B     | 1    | 372     |
| 50641 | 415,10 €             | B     | 1    | 372     |
| 50642 | 499,80 €             | B     | 1    | 372     |
| 50643 | 499,80 €             | B     | 1    | 372     |
| 50644 | 511,00 €             | B     | 1    | 372     |
| 50645 | 511,00 €             | B     | 1    | 372     |
| 50646 | 454,90 €             | B     | 1    | 373     |

| Code  | Prix € HT<br>02/2020 | Prod. | U.E. | Page    |
|-------|----------------------|-------|------|---------|
| 50647 | 454,90 €             | B     | 1    | 373     |
| 50648 | 539,60 €             | B     | 1    | 373     |
| 50649 | 539,60 €             | B     | 1    | 373     |
| 50650 | 550,80 €             | B     | 1    | 373     |
| 50651 | 550,80 €             | B     | 1    | 373     |
| 50652 | 47,90 €              | B     | 1    | 76      |
| 50653 | 47,90 €              | B     | 1    | 76      |
| 50654 | 50,00 €              | B     | 1    | 76      |
| 50655 | 50,00 €              | B     | 1    | 76      |
| 50656 | 34,70 €              | B     | 1    | HC      |
| 50658 | 34,70 €              | B     | 1    | HC      |
| 50659 | 34,70 €              | B     | 1    | HC      |
| 50660 | 373,30 €             | B     | 1    | 371     |
| 50661 | 373,30 €             | B     | 1    | 371     |
| 50662 | 373,30 €             | B     | 1    | 371     |
| 50663 | 373,30 €             | B     | 1    | 371     |
| 50664 | 421,30 €             | B     | 1    | 371     |
| 50665 | 421,30 €             | B     | 1    | 371     |
| 50666 | 421,30 €             | B     | 1    | 371     |
| 50667 | 421,30 €             | B     | 1    | 371     |
| 50668 | 430,40 €             | B     | 1    | 371     |
| 50669 | 430,40 €             | B     | 1    | 371     |
| 50670 | 430,40 €             | B     | 1    | 371     |
| 50671 | 430,40 €             | B     | 1    | 371     |
| 50672 | 40,80 €              | B     | 1    | 146     |
| 50673 | 40,80 €              | B     | 1    | 146     |
| 50674 | 42,80 €              | B     | 1    | 146     |
| 50675 | 42,80 €              | B     | 1    | 146     |
| 50676 | 43,90 €              | B     | 1    | 146     |
| 50677 | 43,90 €              | B     | 1    | 146     |
| 50678 | 81,60 €              | B     | 1    | 147     |
| 50679 | 81,60 €              | B     | 1    | 147     |
| 50680 | 80,60 €              | B     | 1    | 140     |
| 50681 | 80,60 €              | B     | 1    | 140     |
| 50682 | 23,50 €              | B     | 1    | HC      |
| 50683 | 2,50 €               | B     | 1    | 113/187 |
| 50684 | 1,20 €               | B     | 1    | 113/187 |
| 50685 | 149,90 €             | B     | 1    | 316     |
| 50686 | 149,90 €             | B     | 1    | 316     |
| 50687 | 78,50 €              | B     | 1    | 139     |
| 50688 | 78,50 €              | B     | 1    | 139     |
| 50689 | 78,50 €              | B     | 1    | 139     |
| 50690 | 78,50 €              | B     | 1    | 139     |
| 50691 | 78,50 €              | B     | 1    | 138     |
| 50692 | 78,50 €              | B     | 1    | 138     |
| 50693 | 306,00 €             | B     | 1    | 293     |
| 50694 | 306,00 €             | B     | 1    | 293     |
| 50695 | 306,00 €             | B     | 1    | 293     |
| 50696 | 306,00 €             | B     | 1    | 293     |
| 50697 | 293,80 €             | B     | 1    | 276     |
| 50698 | 293,80 €             | B     | 1    | 276     |
| 50699 | 289,70 €             | B     | 1    | 276     |
| 50700 | 289,70 €             | B     | 1    | 276     |
| 50701 | 41,80 €              | B     | 1    | 47      |
| 50702 | 41,80 €              | B     | 1    | 47      |
| 50703 | 49,00 €              | B     | 1    | 47      |
| 50704 | 49,00 €              | B     | 1    | 47      |
| 50705 | 30,60 €              | B     | 1    | 70      |
| 50706 | 30,60 €              | B     | 1    | 70      |
| 50707 | 34,70 €              | B     | 1    | 70      |
| 50708 | 3,30 €               | B     | 1    | 70      |
| 50709 | 3,30 €               | B     | 1    | 70      |
| 50710 | 112,20 €             | B     | 1    | 277     |
| 50711 | 122,40 €             | B     | 1    | 277     |
| 50712 | 274,40 €             | B     | 1    | 291     |
| 50713 | 274,40 €             | B     | 1    | 291     |
| 50714 | 37,70 €              | B     | 1    | 56      |
| 50715 | 52,00 €              | B     | 1    | 56      |
| 50716 | 6,10 €               | B     | 1    | 56      |
| 50717 | 6,10 €               | B     | 1    | 56      |
| 50718 | 7,10 €               | B     | 1    | 56      |

| Code  | Prix € HT<br>02/2020 | Prod. | U.E. | Page    |
|-------|----------------------|-------|------|---------|
| 50719 | 7,10 €               | B     | 1    | 56      |
| 50720 | 29,60 €              | B     | 1    | 74      |
| 50721 | 29,60 €              | B     | 1    | 74      |
| 50722 | 2,70 €               | B     | 1    | 74      |
| 50723 | 2,70 €               | B     | 1    | 74      |
| 50724 | 38,80 €              | B     | 1    | 74      |
| 50725 | 42,80 €              | B     | 1    | 74      |
| 50726 | 38,80 €              | B     | 1    | 74      |
| 50727 | 225,40 €             | B     | 1    | 361     |
| 50728 | 225,40 €             | B     | 1    | 361     |
| 50729 | 54,10 €              | B     | 1    | 268/329 |
| 50730 | 70,40 €              | B     | 1    | 268/329 |
| 50731 | 28,60 €              | B     | 1    | 267/328 |
| 50732 | 50,00 €              | B     | 1    | 267/328 |
| 50733 | 14,60 €              | B     | 1    | 66      |
| 50734 | 15,80 €              | B     | 1    | 66      |
| 50735 | 17,20 €              | B     | 1    | 66      |
| 50736 | 18,40 €              | B     | 1    | 66      |
| 50737 | 49,00 €              | B     | 5    | HC      |
| 50738 | 49,00 €              | B     | 5    | HC      |
| 50739 | 74,50 €              | B     | 5    | 43      |
| 50740 | 74,50 €              | B     | 5    | 43      |
| 50742 | 28,00 €              | B     | 1    | 53      |
| 50743 | 42,00 €              | B     | 1    | 53      |
| 50744 | 62,00 €              | B     | 1    | 53      |
| 50745 | 17,90 €              | B     | 1    | 86      |
| 50746 | 17,90 €              | B     | 1    | 86      |
| 50747 | 16,00 €              | B     | 1    | 81      |
| 50748 | 18,00 €              | B     | 1    | 81      |
| 50749 | 16,60 €              | B     | 1    | 81      |
| 50751 | 168,30 €             | B     | 1    | 135     |
| 50752 | 168,30 €             | B     | 1    | 135     |
| 50753 | 168,30 €             | B     | 1    | 135     |
| 50754 | 168,30 €             | B     | 1    | 135     |
| 50755 | 286,60 €             | B     | 1    | 294     |
| 50756 | 286,60 €             | B     | 1    | 294     |
| 50757 | 286,60 €             | B     | 1    | 294     |
| 50758 | 286,60 €             | B     | 1    | 294     |
| 50759 | 286,60 €             | B     | 1    | 294     |
| 50760 | 286,60 €             | B     | 1    | 294     |
| 50761 | 286,60 €             | B     | 1    | 294     |
| 50762 | 286,60 €             | B     | 1    | 294     |
| 50763 | 274,40 €             | B     | 1    | 291     |
| 50764 | 274,40 €             | B     | 1    | 291     |
| 50765 | 274,40 €             | B     | 1    | 291     |
| 50766 | 274,40 €             | B     | 1    | 291     |
| 50767 | 285,60 €             | B     | 1    | HC      |
| 50768 | 316,20 €             | B     | 1    | HC      |
| 50769 | 387,60 €             | B     | 1    | HC      |
| 50770 | 16,50 €              | C     | 10   | 116     |
| 50771 | 18,80 €              | C     | 10   | 116     |
| 50772 | 17,80 €              | C     | 10   | 116     |
| 50773 | 20,60 €              | C     | 10   | 116     |
| 50774 | 23,50 €              | C     | 10   | 116     |
| 50775 | 67,00 €              | C     | 1    | 116     |
| 50776 | 73,00 €              | C     | 1    | 116     |
| 50777 | 73,00 €              | C     | 1    | 116     |
| 50778 | 93,80 €              | B     | 1    | 58      |
| 50779 | 225,40 €             | B     | 1    | 361     |
| 50780 | 225,40 €             | B     | 1    | 361     |
| 50781 | 90,80 €              | B     | 5    | 43      |
| 50782 | 90,80 €              | B     | 5    | 43      |
| 50784 | 14,00 €              | B     | 1    | 309     |
| 50785 | 85,00 €              | B     | 1    | 309     |
| 50786 | 119,00 €             | B     | 1    | 309     |
| 50787 | 36,00 €              | B     | 1    | 309     |
| 50790 | 23,00 €              | B     | 1    | 72      |
| 50791 | 23,00 €              | B     | 1    | 72      |
| 50792 | 19,00 €              | B     | 1    | 72      |
| 50793 | 19,00 €              | B     | 1    | 72      |

Ces prix sont valables en France métropolitaine et Dom-Tom.

NC : nous consulter - HC : hors catalogue

# LISTE DES CODES (50794 à 51109) - TARIFS 02/2020

| Code  | Prix € HT 02/2020 | Prod. | U.E. | Page    |
|-------|-------------------|-------|------|---------|
| 50794 | 39,00 €           | B     | 1    | 73      |
| 50795 | 39,00 €           | B     | 1    | 73      |
| 50796 | 35,00 €           | B     | 1    | 73      |
| 50797 | 35,00 €           | B     | 1    | 73      |
| 50798 | 37,00 €           | B     | 5    | 45      |
| 50799 | 56,00 €           | B     | 5    | 44      |
| 50800 | 66,00 €           | B     | 5    | 44      |
| 50801 | 18,00 €           | B     | 1    | 55      |
| 50802 | 25,00 €           | B     | 1    | 55      |
| 50803 | 20,00 €           | B     | 1    | 55      |
| 50804 | 37,00 €           | B     | 1    | 55      |
| 50805 | 41,00 €           | B     | 1    | 55      |
| 50806 | 38,00 €           | B     | 1    | 55      |
| 50807 | 41,00 €           | B     | 1    | 55      |
| 50808 | 46,00 €           | B     | 1    | 55      |
| 50809 | 42,00 €           | B     | 1    | 55      |
| 50810 | 119,00 €          | B     | 1    | 317     |
| 50811 | 119,00 €          | B     | 1    | 317     |
| 50814 | 125,00 €          | B     | 1    | 389     |
| 50815 | 60,20 €           | B     | 1    | 313     |
| 50816 | 77,50 €           | B     | 1    | 313     |
| 50817 | 45,00 €           | B     | 1    | 185     |
| 50818 | 52,00 €           | B     | 1    | 185     |
| 50819 | 154,00 €          | B     | 1    | 251     |
| 50820 | 31,00 €           | B     | 1    | 301     |
| 50821 | 31,00 €           | B     | 1    | 301     |
| 50822 | 49,00 €           | B     | 1    | 301     |
| 50823 | 49,00 €           | B     | 1    | 301     |
| 50824 | 85,00 €           | B     | 1    | 301     |
| 50825 | 85,00 €           | B     | 1    | 301     |
| 50826 | 147,00 €          | B     | 1    | 301     |
| 50827 | 147,00 €          | B     | 1    | 301     |
| 50828 | 193,00 €          | B     | 1    | 301     |
| 50829 | 193,00 €          | B     | 1    | 301     |
| 50830 | 31,00 €           | B     | 1    | 300     |
| 50831 | 31,00 €           | B     | 1    | 300     |
| 50832 | 49,00 €           | B     | 1    | 300     |
| 50833 | 49,00 €           | B     | 1    | 300     |
| 50834 | 85,00 €           | B     | 1    | 300     |
| 50835 | 85,00 €           | B     | 1    | 300     |
| 50836 | 147,00 €          | B     | 1    | 300     |
| 50837 | 147,00 €          | B     | 1    | 300     |
| 50838 | 193,00 €          | B     | 1    | 300     |
| 50839 | 193,00 €          | B     | 1    | 300     |
| 50840 | 136,70 €          | B     | 1    | 241/275 |
| 50841 | 157,00 €          | B     | 1    | 244     |
| 50842 | 144,00 €          | B     | 1    | 244     |
| 50843 | 94,00 €           | B     | 1    | 115     |
| 50844 | 94,00 €           | B     | 1    | 115     |
| 50845 | 6,00 €            | B     | 1    | 115     |
| 50846 | 22,00 €           | B     | 1    | 115     |
| 50847 | 22,00 €           | B     | 1    | 115     |
| 50848 | 18,00 €           | B     | 1    | 115     |
| 50849 | 7,00 €            | B     | 1    | 115     |
| 50850 | 518,00 €          | B     | 1    | 305     |
| 50851 | 644,00 €          | B     | 1    | 305     |
| 50852 | 518,00 €          | B     | 1    | 305     |
| 50853 | 644,00 €          | B     | 1    | 305     |
| 50854 | 518,00 €          | B     | 1    | 305     |
| 50855 | 644,00 €          | B     | 1    | 305     |
| 50856 | 518,00 €          | B     | 1    | 305     |
| 50857 | 644,00 €          | B     | 1    | 305     |
| 50858 | 598,00 €          | B     | 1    | 303     |
| 50859 | 747,00 €          | B     | 1    | 303     |
| 50861 | 62,00 €           | B     | 1    | 304     |
| 50862 | 62,00 €           | B     | 1    | 304     |
| 50863 | 97,00 €           | B     | 1    | 304     |
| 50864 | 171,00 €          | B     | 1    | 304     |
| 50866 | 25,20 €           | B     | 1    | 341     |
| 50868 | 127,00 €          | B     | 1    | 257     |
| 50869 | 127,00 €          | B     | 1    | 257     |

| Code  | Prix € HT 02/2020 | Prod. | U.E. | Page    |
|-------|-------------------|-------|------|---------|
| 50870 | 119,00 €          | B     | 1    | 302     |
| 50871 | 180,00 €          | B     | 1    | 302     |
| 50872 | 240,00 €          | B     | 1    | 302     |
| 50873 | 240,00 €          | B     | 1    | 302     |
| 50874 | 86,00 €           | B     | 1    | 307     |
| 50875 | 127,00 €          | B     | 1    | 307     |
| 50876 | 86,00 €           | B     | 1    | 307     |
| 50877 | 127,00 €          | B     | 1    | 307     |
| 50880 | 40,00 €           | B     | 1    | 71      |
| 50881 | 40,00 €           | B     | 1    | 71      |
| 50882 | 4,00 €            | B     | 1    | 71      |
| 50883 | 5,00 €            | B     | 1    | 71      |
| 50884 | 227,00 €          | B     | 1    | 295     |
| 50885 | 257,00 €          | B     | 1    | 295     |
| 50886 | 313,00 €          | B     | 1    | 295     |
| 50887 | 226,00 €          | B     | 1    | 295     |
| 50888 | 254,00 €          | B     | 1    | 295     |
| 50889 | 308,00 €          | B     | 1    | 295     |
| 50890 | 34,00 €           | B     | 1    | 295     |
| 50891 | 40,00 €           | B     | 1    | 295     |
| 50896 | 42,00 €           | B     | 1    | HC      |
| 50897 | 51,00 €           | B     | 1    | HC      |
| 50898 | 38,00 €           | B     | 1    | HC      |
| 50899 | 42,00 €           | B     | 1    | HC      |
| 50907 | 54,00 €           | B     | 1    | 269/331 |
| 50908 | 58,00 €           | B     | 1    | 269/331 |
| 50909 | 78,00 €           | B     | 1    | 269/331 |
| 50910 | 6,80 €            | B     | 1    | 269/331 |
| 50911 | 6,80 €            | B     | 1    | 269/331 |
| 50912 | 3,50 €            | B     | 1    | 269/331 |
| 50913 | 71,00 €           | B     | 1    | 349     |
| 50914 | 42,00 €           | B     | 1    | 323     |
| 50915 | 49,00 €           | B     | 1    | 323     |
| 50916 | 45,00 €           | B     | 1    | 345     |
| 50917 | 58,00 €           | B     | 1    | 345     |
| 50920 | 69,00 €           | B     | 1    | 130     |
| 50921 | 69,00 €           | B     | 1    | 130     |
| 50922 | 69,00 €           | B     | 1    | 130     |
| 50923 | 69,00 €           | B     | 1    | 130     |
| 50924 | 69,00 €           | B     | 1    | 130     |
| 50925 | 69,00 €           | B     | 1    | 130     |
| 50926 | 69,00 €           | B     | 1    | 130     |
| 50927 | 69,00 €           | B     | 1    | 130     |
| 50928 | 77,00 €           | B     | 1    | 131     |
| 50929 | 77,00 €           | B     | 1    | 131     |
| 50930 | 77,00 €           | B     | 1    | 131     |
| 50931 | 77,00 €           | B     | 1    | 131     |
| 50932 | 77,00 €           | B     | 1    | 131     |
| 50933 | 77,00 €           | B     | 1    | 131     |
| 50934 | 77,00 €           | B     | 1    | 131     |
| 50935 | 77,00 €           | B     | 1    | 131     |
| 50936 | 120,00 €          | B     | 1    | 133     |
| 50937 | 120,00 €          | B     | 1    | 133     |
| 50938 | 120,00 €          | B     | 1    | 133     |
| 50939 | 120,00 €          | B     | 1    | 133     |
| 50940 | 120,00 €          | B     | 1    | 133     |
| 50941 | 120,00 €          | B     | 1    | 133     |
| 50942 | 120,00 €          | B     | 1    | 133     |
| 50943 | 120,00 €          | B     | 1    | 133     |
| 50944 | 11,40 €           | B     | 1    | 131     |
| 50945 | 11,40 €           | B     | 1    | 131     |
| 50946 | 9,60 €            | B     | 1    | 131     |
| 50947 | 14,60 €           | B     | 1    | 133     |
| 50948 | 14,60 €           | B     | 1    | 133     |
| 50949 | 14,60 €           | B     | 1    | 133     |
| 50951 | 23,00 €           | B     | 1    | 75      |
| 50952 | 25,00 €           | B     | 1    | 75      |
| 50990 | 135,70 €          | B     | 1    | HC      |
| 50993 | 29,70 €           | B     | 1    | HC      |
| 50994 | 49,60 €           | B     | 1    | HC      |
| 50995 | 85,50 €           | B     | 1    | HC      |

| Code  | Prix € HT 02/2020 | Prod. | U.E. | Page |
|-------|-------------------|-------|------|------|
| 50996 | 182,00 €          | B     | 1    | HC   |
| 51005 | 21,40 €           | B     | 1    | 99   |
| 51006 | 21,40 €           | B     | 1    | 99   |
| 51007 | 21,40 €           | B     | 1    | 99   |
| 51008 | 21,40 €           | B     | 1    | 99   |
| 51010 | 54,10 €           | B     | 1    | HC   |
| 51011 | 54,10 €           | B     | 1    | HC   |
| 51016 | 31,60 €           | B     | 1    | HC   |
| 51020 | 8,20 €            | B     | 10   | 100  |
| 51026 | 35,40 €           | B     | 1    | 83   |
| 51027 | 35,40 €           | B     | 1    | 83   |
| 51028 | 35,40 €           | B     | 1    | 83   |
| 51029 | 35,40 €           | B     | 1    | 83   |
| 51030 | 63,70 €           | B     | 1    | HC   |
| 51031 | 64,60 €           | B     | 1    | HC   |
| 51039 | 44,90 €           | B     | 1    | HC   |
| 51040 | 14,30 €           | B     | 1    | 101  |
| 51041 | 14,30 €           | B     | 1    | 101  |
| 51042 | 15,90 €           | B     | 1    | 101  |
| 51043 | 15,90 €           | B     | 1    | 101  |
| 51044 | 34,40 €           | B     | 1    | 83   |
| 51045 | 34,40 €           | B     | 1    | 83   |
| 51046 | 23,50 €           | B     | 1    | 99   |
| 51047 | 23,50 €           | B     | 1    | 99   |
| 51048 | 23,50 €           | B     | 1    | 99   |
| 51049 | 23,50 €           | B     | 1    | 99   |
| 51050 | 54,10 €           | B     | 1    | HC   |
| 51051 | 54,10 €           | B     | 1    | HC   |
| 51052 | 54,10 €           | B     | 1    | HC   |
| 51053 | 54,10 €           | B     | 1    | HC   |
| 51054 | 12,20 €           | B     | 1    | 101  |
| 51055 | 12,20 €           | B     | 1    | 101  |
| 51056 | 22,40 €           | B     | 1    | HC   |
| 51057 | 22,40 €           | B     | 1    | HC   |
| 51058 | 37,70 €           | B     | 1    | 83   |
| 51059 | 37,70 €           | B     | 1    | 83   |
| 51060 | 33,70 €           | B     | 1    | 106  |
| 51061 | 33,70 €           | B     | 1    | 106  |
| 51062 | 40,30 €           | B     | 1    | 106  |
| 51063 | 40,30 €           | B     | 1    | 106  |
| 51066 | 16,30 €           | B     | 1    | 103  |
| 51067 | 16,30 €           | B     | 1    | 103  |
| 51070 | 43,90 €           | B     | 1    | 16   |
| 51071 | 43,90 €           | B     | 1    | 16   |
| 51072 | 53,50 €           | B     | 1    | 82   |
| 51073 | 65,80 €           | B     | 1    | 82   |
| 51078 | 53,50 €           | B     | 1    | 82   |
| 51079 | 65,80 €           | B     | 1    | 82   |
| 51083 | 60,20 €           | B     | 1    | HC   |
| 51084 | 49,00 €           | B     | 1    | HC   |
| 51085 | 49,00 €           | B     | 1    | 81   |
| 51086 | 49,00 €           | B     | 1    | 81   |
| 51087 | 49,00 €           | B     | 1    | HC   |
| 51089 | 72,40 €           | B     | 1    | HC   |
| 51092 | 53,00 €           | B     | 1    | HC   |
| 51093 | 59,40 €           | B     | 1    | HC   |
| 51095 | 59,40 €           | B     | 1    | HC   |
| 51096 | 66,20 €           | B     | 1    | 98   |
| 51097 | 66,20 €           | B     | 1    | 98   |
| 51098 | 67,20 €           | B     | 1    | 98   |
| 51099 | 67,20 €           | B     | 1    | 98   |
| 51100 | 53,10 €           | B     | 1    | HC   |
| 51101 | 53,10 €           | B     | 1    | HC   |
| 51102 | 54,20 €           | B     | 1    | HC   |
| 51103 | 54,20 €           | B     | 1    | HC   |
| 51104 | 62,60 €           | B     | 1    | HC   |
| 51105 | 63,70 €           | B     | 1    | HC   |
| 51106 | 62,60 €           | B     | 1    | HC   |
| 51107 | 63,70 €           | B     | 1    | HC   |
| 51108 | 52,00 €           | B     | 1    | 77   |
| 51109 | 52,00 €           | B     | 1    | 77   |

Ces prix sont valables en France métropolitaine et Dom-Tom.

# LISTE DES CODES (51110 à 55052) - TARIFS 02/2020

| Code  | Prix € HT 02/2020 | Prod. | U.E. | Page |
|-------|-------------------|-------|------|------|
| 51110 | 53,00 €           | B     | 1    | 77   |
| 51111 | 53,00 €           | B     | 1    | 77   |
| 51112 | 20,40 €           | C     | 1    | HC   |
| 51113 | 20,40 €           | C     | 1    | HC   |
| 51114 | 21,60 €           | C     | 1    | HC   |
| 51115 | 23,60 €           | C     | 1    | HC   |
| 51116 | 26,10 €           | C     | 1    | HC   |
| 51117 | 12,20 €           | B     | 1    | 103  |
| 51118 | 12,20 €           | B     | 1    | 103  |
| 51119 | 14,30 €           | B     | 1    | 103  |
| 51120 | 14,30 €           | B     | 1    | 103  |
| 51121 | 20,40 €           | C     | 1    | HC   |
| 51122 | 20,40 €           | B     | 1    | 99   |
| 51123 | 20,40 €           | B     | 1    | 99   |
| 51124 | 20,40 €           | B     | 1    | 99   |
| 51125 | 20,40 €           | B     | 1    | 99   |
| 51126 | 22,40 €           | B     | 1    | 99   |
| 51127 | 22,40 €           | B     | 1    | 99   |
| 51128 | 22,40 €           | B     | 1    | 99   |
| 51129 | 22,40 €           | B     | 1    | 99   |
| 51132 | 28,60 €           | B     | 1    | HC   |
| 51133 | 28,60 €           | B     | 1    | HC   |
| 51134 | 20,40 €           | C     | 1    | HC   |
| 51135 | 21,60 €           | C     | 1    | HC   |
| 51136 | 17,30 €           | B     | 1    | 103  |
| 51137 | 17,30 €           | B     | 1    | 103  |
| 51138 | 13,30 €           | B     | 1    | 103  |
| 51139 | 13,30 €           | B     | 1    | 103  |
| 51140 | 15,30 €           | B     | 1    | 103  |
| 51141 | 15,30 €           | B     | 1    | 103  |
| 51142 | 31,00 €           | C     | 1    | HC   |
| 51143 | 26,10 €           | C     | 1    | HC   |
| 51144 | 21,40 €           | B     | 1    | 99   |
| 51145 | 21,40 €           | B     | 1    | 99   |
| 51146 | 21,40 €           | B     | 1    | 99   |
| 51147 | 21,40 €           | B     | 1    | 99   |
| 51148 | 23,50 €           | B     | 1    | 99   |
| 51149 | 23,50 €           | B     | 1    | 99   |
| 51150 | 23,50 €           | B     | 1    | 99   |
| 51151 | 23,50 €           | B     | 1    | 99   |
| 51152 | 16,30 €           | B     | 1    | 101  |
| 51153 | 16,30 €           | B     | 1    | 101  |
| 51154 | 18,00 €           | B     | 1    | 101  |
| 51155 | 18,00 €           | B     | 1    | 101  |
| 51156 | 33,70 €           | B     | 1    | 85   |
| 51157 | 34,70 €           | B     | 1    | 85   |
| 51158 | 33,70 €           | B     | 1    | 85   |
| 51159 | 34,70 €           | B     | 1    | 85   |
| 51160 | 32,60 €           | B     | 1    | 85   |
| 51161 | 32,60 €           | B     | 1    | 85   |
| 51162 | 31,60 €           | B     | 1    | 85   |
| 51163 | 31,60 €           | B     | 1    | 85   |
| 51164 | 32,60 €           | B     | 1    | 85   |
| 51165 | 32,60 €           | B     | 1    | 85   |
| 51166 | 31,60 €           | B     | 1    | 85   |
| 51167 | 31,60 €           | B     | 1    | 85   |
| 51168 | 11,20 €           | B     | 1    | 94   |
| 51169 | 11,20 €           | B     | 1    | 94   |
| 51170 | 16,10 €           | B     | 1    | 95   |
| 51171 | 16,10 €           | B     | 1    | 95   |
| 51172 | 18,80 €           | B     | 1    | 96   |
| 51173 | 18,80 €           | B     | 1    | 96   |
| 51174 | 66,20 €           | B     | 1    | 82   |
| 51175 | 66,20 €           | B     | 1    | 82   |
| 51176 | 13,90 €           | B     | 1    | 101  |
| 51177 | 13,90 €           | B     | 1    | 101  |
| 51178 | 496,50 €          | B     | 1    | 62   |
| 51179 | 496,50 €          | B     | 1    | 62   |
| 51180 | 496,50 €          | B     | 1    | 62   |
| 51181 | 496,50 €          | B     | 1    | 62   |
| 51182 | 664,50 €          | B     | 1    | 62   |

| Code  | Prix € HT 02/2020 | Prod. | U.E. | Page    |
|-------|-------------------|-------|------|---------|
| 51183 | 664,50 €          | B     | 1    | 62      |
| 51184 | 664,50 €          | B     | 1    | 62      |
| 51185 | 664,50 €          | B     | 1    | 62      |
| 51186 | 61,20 €           | B     | 1    | 106     |
| 51187 | 61,20 €           | B     | 1    | 106     |
| 51188 | 65,30 €           | B     | 1    | 106     |
| 51189 | 65,30 €           | B     | 1    | 106     |
| 52003 | 22,30 €           | B     | 1    | 428/430 |
| 52004 | 38,20 €           | B     | 1    | 427     |
| 52005 | 38,20 €           | B     | 1    | 428     |
| 52007 | 26,50 €           | B     | 1    | 428     |
| 52010 | 79,60 €           | B     | 1    | 428/432 |
| 52012 | 52,00 €           | B     | 1    | 224/428 |
| 52013 | 357,00 €          | B     | 1    | 224/429 |
| 52016 | 663,00 €          | B     | 1    | 224/429 |
| 52017 | 11,20 €           | B     | 1    | 430     |
| 52022 | 16,30 €           | B     | 1    | HC      |
| 52023 | 16,30 €           | B     | 1    | HC      |
| 52025 | 2,00 €            | B     | 1    | HC      |
| 52026 | 26,50 €           | B     | 1    | 42/45   |
| 52027 | 8,20 €            | B     | 1    | HC      |
| 52028 | 10,20 €           | B     | 1    | HC      |
| 52029 | 18,00 €           | B     | 1    | 427     |
| 52030 | 65,00 €           | B     | 1    | 42/45   |
| 52031 | 12,20 €           | B     | 1    | 115     |
| 53004 | 4,00 €            | B     | 1    | HC      |
| 53010 | 147,90 €          | B     | 1    | 170     |
| 53011 | 155,00 €          | B     | 1    | 170     |
| 53012 | 147,90 €          | B     | 1    | 170     |
| 53013 | 155,00 €          | B     | 1    | 170     |
| 53015 | 21,40 €           | B     | 1    | 182     |
| 53016 | 28,60 €           | B     | 1    | 182     |
| 53017 | 44,90 €           | B     | 1    | 182     |
| 53018 | 58,10 €           | B     | 1    | 182     |
| 53020 | 32,60 €           | B     | 1    | 176     |
| 53021 | 35,00 €           | B     | 1    | 176     |
| 53022 | 39,70 €           | B     | 1    | 176     |
| 53024 | 52,00 €           | B     | 1    | 166     |
| 53025 | 56,10 €           | B     | 1    | 166     |
| 53026 | 63,20 €           | B     | 1    | 166     |
| 53027 | 24,40 €           | B     | 1    | 178     |
| 53028 | 26,80 €           | B     | 1    | 178     |
| 53029 | 31,60 €           | B     | 1    | 178     |
| 53030 | 129,50 €          | B     | 1    | 171     |
| 53031 | 32,60 €           | B     | 1    | 176     |
| 53032 | 35,00 €           | B     | 1    | 176     |
| 53033 | 39,70 €           | B     | 1    | 176     |
| 53034 | 34,00 €           | B     | 1    | 177     |
| 53035 | 36,40 €           | B     | 1    | 177     |
| 53036 | 40,90 €           | B     | 1    | 177     |
| 53037 | 38,40 €           | B     | 1    | 174     |
| 53038 | 40,10 €           | B     | 1    | 174     |
| 53039 | 45,80 €           | B     | 1    | 174     |
| 53040 | 67,00 €           | B     | 1    | 174     |
| 53041 | 46,90 €           | B     | 1    | 166     |
| 53042 | 51,00 €           | B     | 1    | 166     |
| 53043 | 58,10 €           | B     | 1    | 166     |
| 53044 | 41,80 €           | B     | 1    | 167     |
| 53045 | 45,90 €           | B     | 1    | 167     |
| 53046 | 54,10 €           | B     | 1    | 167     |
| 53051 | 87,70 €           | B     | 1    | 169     |
| 53052 | 77,50 €           | B     | 1    | 233/261 |
| 53057 | 41,80 €           | B     | 1    | 167     |
| 53058 | 45,90 €           | B     | 1    | 167     |
| 53059 | 54,10 €           | B     | 1    | 167     |
| 53060 | 61,20 €           | B     | 1    | 166     |
| 53061 | 66,30 €           | B     | 1    | 166     |
| 53062 | 56,10 €           | B     | 1    | 167     |
| 53063 | 19,00 €           | B     | 1    | HC      |
| 53064 | 24,60 €           | B     | 1    | HC      |
| 53065 | 31,60 €           | B     | 1    | 182     |

| Code  | Prix € HT 02/2020 | Prod. | U.E. | Page      |
|-------|-------------------|-------|------|-----------|
| 53067 | 38,40 €           | B     | 1    | 174       |
| 53068 | 40,10 €           | B     | 1    | 174       |
| 53069 | 45,80 €           | B     | 1    | 174       |
| 53070 | 67,00 €           | B     | 1    | 174       |
| 53071 | 56,10 €           | B     | 1    | 167       |
| 53072 | 39,80 €           | B     | 1    | 169       |
| 53073 | 39,80 €           | B     | 1    | 169       |
| 53074 | 43,90 €           | B     | 1    | 169       |
| 53075 | 43,90 €           | B     | 1    | 169       |
| 53076 | 107,10 €          | B     | 1    | 173       |
| 53077 | 111,20 €          | B     | 1    | 173       |
| 53078 | 35,20 €           | B     | 4    | 183       |
| 53079 | 46,40 €           | B     | 4    | 183       |
| 53080 | 129,50 €          | B     | 1    | 171       |
| 54000 | 27,50 €           | A     | 10   | 35        |
| 54001 | 31,60 €           | A     | 10   | 35        |
| 54002 | 34,70 €           | A     | 10   | 35        |
| 54003 | 39,80 €           | A     | 10   | 35        |
| 54011 | 41,80 €           | A     | 10   | 242       |
| 54016 | 56,10 €           | B     | 1    | 242       |
| 54017 | 56,10 €           | B     | 1    | 242       |
| 54018 | 56,10 €           | B     | 1    | 242       |
| 55001 | 1,90 €            | B     | 1    | 211 & 216 |
| 55003 | 2,20 €            | B     | 1    | 211 & 216 |
| 55004 | 1,90 €            | B     | 1    | 215/217   |
| 55006 | 2,80 €            | B     | 1    | 215/217   |
| 55007 | 62,20 €           | B     | 1    | 225       |
| 55009 | 25,50 €           | B     | 1    | 225       |
| 55010 | 53,00 €           | B     | 1    | HC        |
| 55011 | 53,00 €           | B     | 1    | HC        |
| 55012 | 76,50 €           | B     | 1    | 220       |
| 55013 | 76,50 €           | B     | 1    | 220       |
| 55014 | 125,50 €          | B     | 1    | 220       |
| 55015 | 125,50 €          | B     | 1    | 220       |
| 55016 | 53,00 €           | B     | 1    | HC        |
| 55017 | 76,50 €           | B     | 1    | HC        |
| 55018 | 125,50 €          | B     | 1    | HC        |
| 55019 | 61,20 €           | B     | 1    | 219       |
| 55020 | 61,20 €           | B     | 1    | 219       |
| 55021 | 89,80 €           | B     | 1    | 219       |
| 55022 | 89,80 €           | B     | 1    | 219       |
| 55023 | 76,50 €           | B     | 1    | 218       |
| 55024 | 76,50 €           | B     | 1    | 218       |
| 55025 | 76,50 €           | B     | 1    | HC        |
| 55026 | 76,50 €           | B     | 1    | HC        |
| 55027 | 76,50 €           | B     | 1    | HC        |
| 55028 | 122,40 €          | B     | 1    | 218       |
| 55029 | 122,40 €          | B     | 1    | 218       |
| 55030 | 122,40 €          | B     | 1    | 218       |
| 55031 | 122,40 €          | B     | 1    | 218       |
| 55032 | 122,40 €          | B     | 1    | 218       |
| 55033 | 83,60 €           | B     | 1    | 214       |
| 55034 | 83,60 €           | B     | 1    | 214       |
| 55035 | 83,60 €           | B     | 1    | 214       |
| 55036 | 106,10 €          | B     | 1    | HC        |
| 55037 | 106,10 €          | B     | 1    | HC        |
| 55038 | 106,10 €          | B     | 1    | HC        |
| 55039 | 163,20 €          | B     | 1    | HC        |
| 55040 | 126,50 €          | B     | 1    | HC        |
| 55041 | 126,50 €          | B     | 1    | HC        |
| 55042 | 126,50 €          | B     | 1    | HC        |
| 55043 | 202,00 €          | B     | 1    | HC        |
| 55044 | 162,20 €          | B     | 1    | HC        |
| 55045 | 162,20 €          | B     | 1    | HC        |
| 55046 | 162,20 €          | B     | 1    | HC        |
| 55047 | 280,50 €          | B     | 1    | HC        |
| 55048 | 108,10 €          | B     | 1    | 215       |
| 55049 | 1,10 €            | B     | 5    | 206       |
| 55050 | 66,30 €           | B     | 1    | 207       |
| 55051 | 66,30 €           | B     | 1    | 207       |
| 55052 | 109,10 €          | B     | 1    | 207       |

Ces prix sont valables en France métropolitaine et Dom-Tom.

NC : nous consulter - HC : hors catalogue



# LISTE DES CODES (55053 à 55342) - TARIFS 02/2020

| Code  | Prix € HT 02/2020 | Prod. | U.E. | Page |
|-------|-------------------|-------|------|------|
| 55053 | 109,10 €          | B     | 1    | 207  |
| 55054 | 78,50 €           | B     | 1    | 207  |
| 55055 | 78,50 €           | B     | 1    | 207  |
| 55056 | 131,60 €          | B     | 1    | 207  |
| 55057 | 131,60 €          | B     | 1    | 207  |
| 55058 | 96,90 €           | B     | 1    | 206  |
| 55059 | 96,90 €           | B     | 1    | 206  |
| 55060 | 96,90 €           | B     | 1    | 206  |
| 55061 | 174,40 €          | B     | 1    | 206  |
| 55062 | 174,40 €          | B     | 1    | 206  |
| 55063 | 174,40 €          | B     | 1    | 206  |
| 55070 | 83,60 €           | B     | 1    | 214  |
| 55071 | 106,10 €          | B     | 1    | HC   |
| 55072 | 126,50 €          | B     | 1    | HC   |
| 55073 | 146,90 €          | B     | 1    | 214  |
| 55074 | 162,20 €          | B     | 1    | HC   |
| 55075 | 146,90 €          | B     | 1    | 214  |
| 55076 | 146,90 €          | B     | 1    | 214  |
| 55077 | 146,90 €          | B     | 1    | 214  |
| 55078 | 244,80 €          | B     | 1    | 215  |
| 55080 | 76,50 €           | B     | 1    | 218  |
| 55081 | 122,40 €          | B     | 1    | 218  |
| 55082 | 85,70 €           | B     | 1    | HC   |
| 55083 | 142,80 €          | B     | 1    | 221  |
| 55084 | 247,90 €          | B     | 1    | 221  |
| 55091 | 76,40 €           | B     | 1    | 222  |
| 55092 | 2,30 €            | B     | 1    | 222  |
| 55093 | 72,10 €           | B     | 1    | 222  |
| 55094 | 2,60 €            | B     | 1    | 222  |
| 55097 | 96,90 €           | B     | 1    | 222  |
| 55099 | 1,10 €            | B     | 1    | HC   |
| 55100 | 1,10 €            | B     | 1    | HC   |
| 55101 | 1,10 €            | B     | 1    | HC   |
| 55102 | 1,10 €            | B     | 1    | HC   |
| 55103 | 1,30 €            | B     | 1    | HC   |
| 55104 | 104,00 €          | B     | 1    | HC   |
| 55105 | 104,00 €          | B     | 1    | HC   |
| 55106 | 104,00 €          | B     | 1    | HC   |
| 55107 | 121,40 €          | B     | 1    | HC   |
| 55108 | 121,40 €          | B     | 1    | HC   |
| 55109 | 121,40 €          | B     | 1    | HC   |
| 55110 | 53,00 €           | B     | 1    | 223  |
| 55112 | 79,60 €           | B     | 1    | 223  |
| 55116 | 0,80 €            | B     | 1    | 223  |
| 55118 | 2,00 €            | B     | 1    | 223  |
| 55119 | 1,10 €            | B     | 1    | 203  |
| 55120 | 1,10 €            | B     | 1    | 203  |
| 55121 | 59,00 €           | B     | 1    | 218  |
| 55122 | 99,00 €           | B     | 1    | 218  |
| 55123 | 45,00 €           | B     | 1    | 219  |
| 55124 | 71,00 €           | B     | 1    | 219  |
| 55125 | 60,00 €           | B     | 1    | 220  |
| 55126 | 89,00 €           | B     | 1    | 220  |
| 55130 | 0,50 €            | B     | 1    | HC   |
| 55131 | 0,50 €            | B     | 1    | HC   |
| 55132 | 0,50 €            | B     | 1    | HC   |
| 55133 | 0,60 €            | B     | 1    | HC   |
| 55134 | 0,60 €            | B     | 1    | HC   |
| 55135 | 0,70 €            | B     | 1    | HC   |
| 55136 | 0,70 €            | B     | 1    | HC   |
| 55137 | 0,70 €            | B     | 1    | HC   |
| 55138 | 0,70 €            | B     | 1    | HC   |
| 55139 | 0,70 €            | B     | 1    | HC   |
| 55140 | 0,70 €            | B     | 1    | HC   |
| 55141 | 0,50 €            | B     | 1    | HC   |
| 55142 | 0,50 €            | B     | 1    | HC   |
| 55143 | 0,50 €            | B     | 1    | HC   |
| 55144 | 0,60 €            | B     | 1    | HC   |
| 55145 | 0,60 €            | B     | 1    | HC   |
| 55146 | 0,70 €            | B     | 1    | HC   |
| 55147 | 0,70 €            | B     | 1    | HC   |

| Code  | Prix € HT 02/2020 | Prod. | U.E. | Page |
|-------|-------------------|-------|------|------|
| 55148 | 0,70 €            | B     | 1    | HC   |
| 55149 | 0,70 €            | B     | 1    | HC   |
| 55150 | 0,70 €            | B     | 1    | HC   |
| 55151 | 0,70 €            | B     | 1    | HC   |
| 55170 | 0,30 €            | B     | 1    | HC   |
| 55171 | 0,30 €            | B     | 1    | HC   |
| 55172 | 0,30 €            | B     | 1    | HC   |
| 55173 | 0,30 €            | B     | 1    | HC   |
| 55174 | 0,30 €            | B     | 1    | HC   |
| 55175 | 0,40 €            | B     | 1    | HC   |
| 55176 | 0,40 €            | B     | 1    | HC   |
| 55177 | 0,40 €            | B     | 1    | HC   |
| 55178 | 0,40 €            | B     | 1    | HC   |
| 55179 | 0,40 €            | B     | 1    | HC   |
| 55180 | 0,40 €            | B     | 1    | HC   |
| 55181 | 0,40 €            | B     | 1    | HC   |
| 55182 | 0,50 €            | B     | 1    | HC   |
| 55183 | 0,50 €            | B     | 1    | HC   |
| 55184 | 0,50 €            | B     | 1    | HC   |
| 55185 | 0,50 €            | B     | 1    | HC   |
| 55186 | 0,90 €            | B     | 1    | HC   |
| 55190 | 51,00 €           | B     | 1    | 216  |
| 55191 | 51,00 €           | B     | 1    | 216  |
| 55192 | 51,00 €           | B     | 1    | 216  |
| 55193 | 69,00 €           | B     | 1    | 217  |
| 55194 | 84,00 €           | B     | 1    | 216  |
| 55195 | 84,00 €           | B     | 1    | 216  |
| 55196 | 84,00 €           | B     | 1    | 216  |
| 55197 | 119,00 €          | B     | 1    | 217  |
| 55200 | 101,00 €          | B     | 1    | 214  |
| 55201 | 101,00 €          | B     | 1    | 214  |
| 55202 | 101,00 €          | B     | 1    | 214  |
| 55203 | 101,00 €          | B     | 1    | 214  |
| 55204 | 176,50 €          | B     | 1    | HC   |
| 55205 | 176,50 €          | B     | 1    | HC   |
| 55206 | 176,50 €          | B     | 1    | HC   |
| 55207 | 176,50 €          | B     | 1    | HC   |
| 55208 | 289,70 €          | B     | 1    | HC   |
| 55209 | 195,80 €          | B     | 1    | HC   |
| 55210 | 195,80 €          | B     | 1    | HC   |
| 55211 | 195,80 €          | B     | 1    | HC   |
| 55212 | 195,80 €          | B     | 1    | HC   |
| 55213 | 326,40 €          | B     | 1    | HC   |
| 55214 | 263,20 €          | B     | 1    | 214  |
| 55215 | 263,20 €          | B     | 1    | 214  |
| 55216 | 263,20 €          | B     | 1    | 214  |
| 55217 | 263,20 €          | B     | 1    | 214  |
| 55218 | 430,40 €          | B     | 1    | 215  |
| 55219 | 228,50 €          | B     | 1    | 215  |
| 55220 | 89,00 €           | B     | 1    | 216  |
| 55221 | 89,00 €           | B     | 1    | 216  |
| 55222 | 89,00 €           | B     | 1    | 216  |
| 55223 | 106,00 €          | B     | 1    | 217  |
| 55224 | 147,00 €          | B     | 1    | 216  |
| 55225 | 147,00 €          | B     | 1    | 216  |
| 55226 | 147,00 €          | B     | 1    | 216  |
| 55227 | 182,00 €          | B     | 1    | 217  |
| 55229 | 85,00 €           | B     | 1    | 220  |
| 55230 | 74,50 €           | B     | 1    | HC   |
| 55231 | 74,50 €           | B     | 1    | HC   |
| 55232 | 114,00 €          | B     | 1    | 220  |
| 55233 | 109,10 €          | B     | 1    | 220  |
| 55234 | 109,10 €          | B     | 1    | 220  |
| 55236 | 155,00 €          | B     | 1    | 220  |
| 55237 | 155,00 €          | B     | 1    | 220  |
| 55239 | 94,90 €           | B     | 1    | 219  |
| 55240 | 94,90 €           | B     | 1    | 219  |
| 55241 | 121,40 €          | B     | 1    | 219  |
| 55242 | 121,40 €          | B     | 1    | 219  |
| 55243 | 108,10 €          | B     | 1    | 218  |
| 55244 | 108,10 €          | B     | 1    | 218  |

| Code  | Prix € HT 02/2020 | Prod. | U.E. | Page    |
|-------|-------------------|-------|------|---------|
| 55245 | 108,10 €          | B     | 1    | 218     |
| 55246 | 74,00 €           | B     | 1    | 219     |
| 55247 | 99,60 €           | B     | 1    | 219     |
| 55249 | 182,60 €          | B     | 1    | 218     |
| 55250 | 182,60 €          | B     | 1    | 218     |
| 55251 | 182,60 €          | B     | 1    | 218     |
| 55252 | 88,00 €           | B     | 1    | 218     |
| 55253 | 137,00 €          | B     | 1    | 218     |
| 55255 | 103,00 €          | B     | 1    | HC      |
| 55256 | 157,10 €          | B     | 1    | 221     |
| 55257 | 257,00 €          | B     | 1    | 221     |
| 55260 | 31,60 €           | B     | 1    | 196     |
| 55261 | 75,50 €           | B     | 1    | 196     |
| 55262 | 120,40 €          | B     | 1    | 196     |
| 55263 | 210,10 €          | B     | 1    | 196     |
| 55264 | 16,30 €           | B     | 1    | 196     |
| 55265 | 31,60 €           | B     | 1    | 196     |
| 55266 | 75,50 €           | B     | 1    | 196     |
| 55267 | 120,40 €          | B     | 1    | 196     |
| 55268 | 210,10 €          | B     | 1    | 196     |
| 55270 | 71,20 €           | B     | 1    | 212     |
| 55271 | 71,20 €           | B     | 1    | 212     |
| 55272 | 142,50 €          | B     | 1    | 212     |
| 55273 | 142,50 €          | B     | 1    | 212     |
| 55274 | 134,60 €          | B     | 1    | 212     |
| 55275 | 134,60 €          | B     | 1    | 212     |
| 55276 | 274,40 €          | B     | 1    | 212     |
| 55277 | 274,40 €          | B     | 1    | 212     |
| 55278 | 109,00 €          | B     | 1    | 213     |
| 55279 | 109,00 €          | B     | 1    | 213     |
| 55280 | 218,10 €          | B     | 1    | 213     |
| 55281 | 218,10 €          | B     | 1    | 213     |
| 55282 | 179,50 €          | B     | 1    | 213     |
| 55283 | 179,50 €          | B     | 1    | 213     |
| 55284 | 345,80 €          | B     | 1    | 213     |
| 55285 | 345,80 €          | B     | 1    | 213     |
| 55290 | 181,00 €          | B     | 1    | 197     |
| 55291 | 181,00 €          | B     | 1    | 197     |
| 55292 | 9,20 €            | B     | 1    | 197     |
| 55293 | 0,40 €            | B     | 1    | 197     |
| 55294 | 289,00 €          | B     | 1    | 197     |
| 55295 | 289,00 €          | B     | 1    | 197     |
| 55301 | 224,40 €          | B     | 1    | 195     |
| 55302 | 224,40 €          | B     | 1    | 195     |
| 55303 | 397,80 €          | B     | 1    | 195     |
| 55304 | 397,80 €          | B     | 1    | 195     |
| 55310 | 346,80 €          | B     | 1    | 195     |
| 55311 | 346,80 €          | B     | 1    | 195     |
| 55312 | 632,40 €          | B     | 1    | 195     |
| 55313 | 632,40 €          | B     | 1    | 195     |
| 55314 | 3,70 €            | B     | 1    | 194     |
| 55315 | 14,20 €           | B     | 1    | 194     |
| 55316 | 12,10 €           | B     | 1    | 194     |
| 55317 | 12,10 €           | B     | 1    | 194     |
| 55318 | 24,30 €           | B     | 1    | 194     |
| 55319 | 0,50 €            | B     | 1    | 194     |
| 55320 | 187,70 €          | B     | 1    | 202     |
| 55321 | 333,50 €          | B     | 1    | HC      |
| 55322 | 373,30 €          | B     | 1    | HC      |
| 55323 | 418,20 €          | B     | 1    | 202     |
| 55330 | 4,00 €            | B     | 5    | 218a221 |
| 55331 | 3,30 €            | B     | 5    | 218a221 |
| 55332 | 1,10 €            | B     | 5    | 218a221 |
| 55333 | 4,10 €            | B     | 5    | 218a221 |
| 55334 | 2,30 €            | B     | 5    | 218a221 |
| 55335 | 1,10 €            | B     | 5    | 218a221 |
| 55336 | 0,20 €            | B     | 5    | 218a221 |
| 55337 | 0,20 €            | B     | 5    | 218a221 |
| 55340 | 1,20 €            | B     | 5    | 218a216 |
| 55341 | 0,20 €            | B     | 5    | 218a216 |
| 55342 | 0,20 €            | B     | 5    | 218a216 |

Ces prix sont valables en France métropolitaine et Dom-Tom.

## LISTE DES CODES (55345 à 55810) - TARIFS 02/2020

| Code  | Prix € HT<br>02/2020 | Prod. | U.E. | Page    |
|-------|----------------------|-------|------|---------|
| 55345 | 1,20 €               | B     | 5    | 215/217 |
| 55348 | 79,50 €              | B     | 1    | 208     |
| 55349 | 79,50 €              | B     | 1    | 208     |
| 55350 | 102,00 €             | B     | 1    | 209     |
| 55351 | 102,00 €             | B     | 1    | 209     |
| 55352 | 63,00 €              | B     | 1    | 210     |
| 55353 | 50,00 €              | B     | 1    | 210     |
| 55354 | 50,00 €              | B     | 1    | 210     |
| 55355 | 120,00 €             | B     | 1    | 211     |
| 55356 | 120,00 €             | B     | 1    | 211     |
| 55360 | 101,00 €             | B     | 1    | 200     |
| 55361 | 101,00 €             | B     | 1    | 200     |
| 55362 | 202,00 €             | B     | 1    | 200     |
| 55363 | 202,00 €             | B     | 1    | 200     |
| 55364 | 94,00 €              | B     | 1    | 201     |
| 55365 | 94,00 €              | B     | 1    | 201     |
| 55366 | 186,00 €             | B     | 1    | 201     |
| 55367 | 186,00 €             | B     | 1    | 201     |
| 55368 | 125,00 €             | B     | 1    | 198     |
| 55369 | 125,00 €             | B     | 1    | 198     |
| 55370 | 247,00 €             | B     | 1    | 198     |
| 55371 | 247,00 €             | B     | 1    | 198     |
| 55372 | 132,00 €             | B     | 1    | 199     |

| Code  | Prix € HT<br>02/2020 | Prod. | U.E. | Page    |
|-------|----------------------|-------|------|---------|
| 55373 | 261,00 €             | B     | 1    | 199     |
| 55380 | 113,00 €             | B     | 1    | 204     |
| 55381 | 113,00 €             | B     | 1    | 204     |
| 55382 | 113,00 €             | B     | 1    | 204     |
| 55383 | 130,00 €             | B     | 1    | 204     |
| 55384 | 159,00 €             | B     | 1    | 204     |
| 55385 | 159,00 €             | B     | 1    | 204     |
| 55386 | 159,00 €             | B     | 1    | 204     |
| 55387 | 194,00 €             | B     | 1    | 204     |
| 55388 | 151,00 €             | B     | 1    | 204     |
| 55389 | 151,00 €             | B     | 1    | 204     |
| 55390 | 151,00 €             | B     | 1    | 204     |
| 55391 | 168,00 €             | B     | 1    | 204     |
| 55392 | 227,00 €             | B     | 1    | 204     |
| 55393 | 227,00 €             | B     | 1    | 204     |
| 55394 | 227,00 €             | B     | 1    | 204     |
| 55395 | 261,00 €             | B     | 1    | 204     |
| 55396 | 0,45 €               | B     | 1    | 205     |
| 55397 | 0,45 €               | B     | 1    | 205/205 |
| 55398 | 0,45 €               | B     | 1    | 205     |
| 55399 | 0,80 €               | B     | 1    | 205     |
| 55400 | 0,04 €               | B     | 1    | 205     |
| 55401 | 0,80 €               | B     | 1    | HC      |

| Code  | Prix € HT<br>02/2020 | Prod. | U.E. | Page |
|-------|----------------------|-------|------|------|
| 55402 | 0,80 €               | B     | 1    | 189  |
| 55403 | 0,80 €               | B     | 1    | 189  |
| 55404 | 0,80 €               | B     | 1    | 189  |
| 55405 | 0,80 €               | B     | 1    | 189  |
| 55406 | 0,80 €               | B     | 1    | 189  |
| 55407 | 0,80 €               | B     | 1    | 189  |
| 55408 | 59,20 €              | B     | 1    | 188  |
| 55409 | 59,20 €              | B     | 1    | 188  |
| 55411 | 0,80 €               | B     | 1    | HC   |
| 55412 | 0,80 €               | B     | 1    | 189  |
| 55413 | 0,80 €               | B     | 1    | 189  |
| 55414 | 0,80 €               | B     | 1    | 189  |
| 55415 | 0,80 €               | B     | 1    | 189  |
| 55416 | 0,80 €               | B     | 1    | 189  |
| 55417 | 0,80 €               | B     | 1    | 189  |
| 55430 | 85,70 €              | B     | 1    | HC   |
| 55431 | 85,70 €              | B     | 1    | HC   |
| 55432 | 1,20 €               | B     | 5    | 188  |
| 55433 | 3,00 €               | B     | 2    | 188  |
| 55800 | 59,20 €              | B     | 1    | HC   |
| 55810 | 6,10 €               | B     | 1    | HC   |

Ces prix sont valables en France métropolitaine et Dom-Tom.

NC : nous consulter - HC : hors catalogue

## NOTES

Area for notes with horizontal dashed lines.

## NOTES

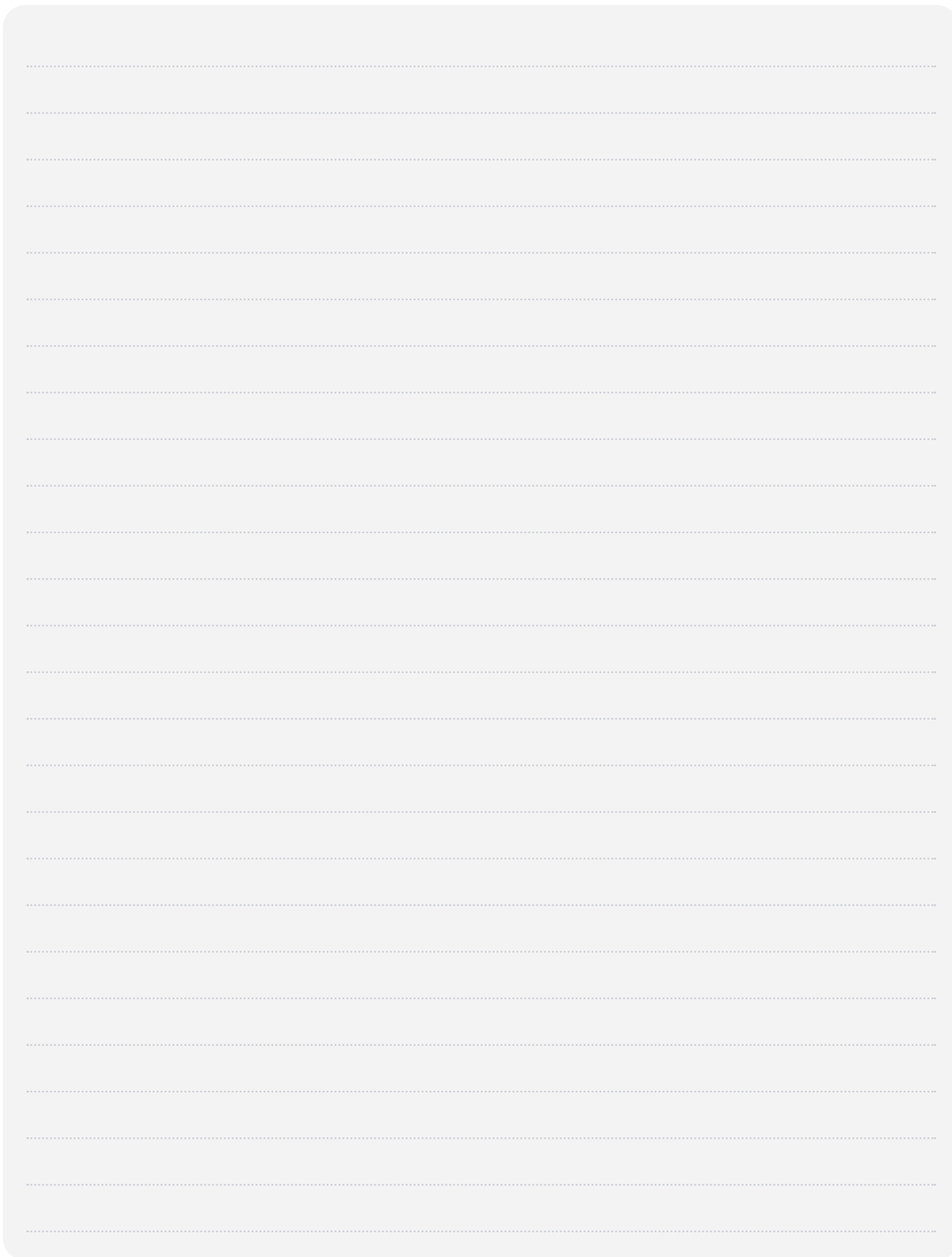

A large, light gray rounded rectangle containing horizontal dotted lines for writing notes. The lines are evenly spaced and extend across the width of the rectangle.

# Demande de Catalogue

Pour recevoir le prochain Catalogue Général,  
adresser le coupon ci-dessous dûment rempli à :

**Service Commercial ARIC**  
**www.aric-sa.com**  
**FAX : 01 60 54 62 82**



SOCIÉTÉ : .....

NOM : ..... PRÉNOM : .....

FONCTION : .....

ADRESSE : .....

VILLE : ..... CODE POSTAL : .....

TÉL : ..... FAX : ..... MAIL : .....

ARTISAN

S.A.R.L.

S.A.

### Secteur d'activité

Bâtiment / électricité

Tertiaire

Agenceur

Service maintenance

Magasin luminaire

Chaîne magasin

### Prescripteur

Bureau d'étude

Architecte

Décorateur

Autre

**Soucieuse d'assurer un service de qualité,  
la société ARIC est à l'écoute de ses clients.**

**Merci de nous faire part de toutes vos remarques :**

.....  
.....  
.....  
.....  
.....  
.....  
.....

Cachet de votre société

.....

La Newsletter  
**ARIC**

En cochant  
ici, je m'abonne  
à la Newsletter !



## DÉCOUPES - ENCASTRÉS DE PLAFOND

| Dimensions d'encastrement | Profondeur | GAMME | Type de luminaire | Classe | IP | Vol. | Orientable | Dimmable | CCT | Recouvrable | BBC / RT2012 | Page |
|---------------------------|------------|-------|-------------------|--------|----|------|------------|----------|-----|-------------|--------------|------|
|---------------------------|------------|-------|-------------------|--------|----|------|------------|----------|-----|-------------|--------------|------|

### Encastrés miniatures - Encastrement inférieur à 50 mm

|       |         |             |     |     |       |         |  |  |  |  |  |        |
|-------|---------|-------------|-----|-----|-------|---------|--|--|--|--|--|--------|
| 12 mm | 12 mm   | SPARK       | LED | II  | 20/43 | H. Vol. |  |  |  |  |  | p. 112 |
| 26 mm | 43 mm   | LUCIA 1 / 2 | LED | III | 20/44 | Vol. 1  |  |  |  |  |  | p. 109 |
| 36 mm | 28,5 mm | MICRO LEM   | LED | II  | 20    |         |  |  |  |  |  | p. 93  |
| 36 mm | 40 mm   | PEARL 2     | LED | III | 20    |         |  |  |  |  |  | p. 111 |
| 46 mm | 7 mm    | MINI SAT    | G4  | III | 20    |         |  |  |  |  |  | p. 108 |

### Encastrés à diamètre réglable

|           |       |               |     |    |    |  |  |  |  |  |  |       |
|-----------|-------|---------------|-----|----|----|--|--|--|--|--|--|-------|
| 55-125 mm | 15 mm | UNIVERSAL 12W | LED | II | 20 |  |  |  |  |  |  | p. 56 |
| 55-175 mm | 15 mm | UNIVERSAL 18W | LED | II | 20 |  |  |  |  |  |  | p. 56 |

### Encastrés - Encastrement entre 50 mm et 100 mm

|          |         |                      |       |          |       |         |  |  |  |  |       |        |
|----------|---------|----------------------|-------|----------|-------|---------|--|--|--|--|-------|--------|
| 56 mm    | 44 mm   | LUCIA XL6            | LED   | II       | 20/44 | Vol. 1  |  |  |  |  |       | p. 81  |
| 58 mm    | 135 mm  | LUNAR 35             | G4    | III      | 20    |         |  |  |  |  |       | p. 108 |
| 59 mm    | 15 mm   | MEUBLED IP65         | LED   | II / III | 20/65 | Vol. 2  |  |  |  |  |       | p. 115 |
| 60 mm    | 11 mm   | MEUBLED 2            | LED   | III      | 44    |         |  |  |  |  |       | p. 114 |
|          | 14 mm   | MEUBLED 2 IP44       | LED   | III      | 20    |         |  |  |  |  |       | p. 116 |
|          | 18 mm   | S1200 LED / S307 LED | G4    | III      | 20    |         |  |  |  |  |       | p. 116 |
| 60-75 mm | 69 mm   | EF6                  | LED   | I        | 20/65 | H. Vol. |  |  |  |  |       | p. 68  |
| 62 mm    | 120 mm  | FIXO                 | GU5,3 | II / III | 20    |         |  |  |  |  |       | p. 104 |
|          | 123 mm  | FIXO                 | GU10  | II       | 20    |         |  |  |  |  |       | p. 105 |
|          | 123 mm  | DISK                 | GU10  | II       | 20    |         |  |  |  |  |       | p. 105 |
| 63-70 mm | 57 mm   | EF6 CCT              | LED   | I        | 20/65 | H. Vol. |  |  |  |  |       | p. 69  |
| 65 mm    | 63 mm   | SATURNE              | GU5,3 | III      | 20    |         |  |  |  |  |       | p. 105 |
| 67 mm    | 57 mm   | AIR BLOCK 2          | LED   | I        | 65    | H. Vol. |  |  |  |  |       | p. 71  |
| 68 mm    | 58 mm   | K8                   | LED   | II       | 20    |         |  |  |  |  |       | p. 91  |
| 68-75 mm | 44 mm   | ELODY 2 6W           | LED   | II       | 20    |         |  |  |  |  |       | p. 86  |
| 70 mm    | 22 mm   | FLAT CCT 5W          | LED   | II       | 20    |         |  |  |  |  |       | p. 55  |
|          | 23 mm   | FLAT LED 5W          | LED   | II       | 20    |         |  |  |  |  |       | p. 54  |
|          | 26 mm   | MI 6                 | LED   | II       | 20    |         |  |  |  |  |       | p. 87  |
|          | 28 mm   | MI 5                 | LED   | II       | 20    |         |  |  |  |  |       | p. 92  |
|          | 50 mm   | EYDI                 | LED   | II       | 20    |         |  |  |  |  |       | p. 87  |
|          | 58 mm   | AVERY                | LED   | II       | 20/44 | Vol. 2  |  |  |  |  |       | p. 79  |
|          | 64 mm   | GRACE 5-7W           | LED   | II       | 20/44 | Vol. 2  |  |  |  |  |       | p. 51  |
|          | 74 mm   | AXEL basculant       | LED   | II       | 20/65 | Vol. 2  |  |  |  |  |       | p. 74  |
|          | 80 mm   | AXEL fixe            | LED   | II       | 20/65 | Vol. 2  |  |  |  |  |       | p. 74  |
|          | 82 mm   | ELITE F5 / S5        | LED   | II       | 20    |         |  |  |  |  |       | p. 88  |
|          | 95 mm   | ELITE F6             | LED   | II       | 20    |         |  |  |  |  |       | p. 88  |
|          | 107 mm  | SPEED R50-12         | GU5,3 | II / III | 20    |         |  |  |  |  |       | p. 94  |
|          | 107 mm  | SPEED R50-230        | GU10  | II       | 20    |         |  |  |  |  |       | p. 94  |
|          | 107 mm  | SPEED 50 IP65        | GU10  | II       | 20/65 | Vol. 2  |  |  |  |  |       | p. 85  |
|          | 115 mm  | TIPO 230             | GU10  | II       | 20    |         |  |  |  |  |       | p. 99  |
| 123 mm   | TIPO 12 | GU5,3                | III   | 20       |       |         |  |  |  |  | p. 98 |        |

## DÉCOUPES - ENCASTRÉS DE PLAFOND

| Dimensions d'encastrement | Profondeur | GAMME                | Type de luminaire | Classe   | IP    | Vol.    | Orientable | Dimmable | CCT | Recouvrable | BBC / RT2012 | Page   |
|---------------------------|------------|----------------------|-------------------|----------|-------|---------|------------|----------|-----|-------------|--------------|--------|
| 70-75 mm                  | 56 mm      | <b>LOKI 6W</b>       | LED               | II       | 20/44 | Vol. 2  |            |          |     |             |              | p. 75  |
| 72 mm                     | 76 mm      | <b>HIDRO XL6</b>     | LED XL6           | II / III | 20/65 | Vol. 1  |            |          |     |             |              | p. 82  |
|                           | 89 mm      | <b>DL-ISO IP65</b>   | LED               | II       | 20/65 | Vol. 2  |            |          |     |             |              | p. 76  |
|                           | 115 mm     | <b>ZETA IP65</b>     | GU5,3             | II / III | 20/65 | Vol. 1  |            |          |     |             |              | p. 84  |
|                           | 115 mm     | <b>ZETA IP20</b>     | GU5,3             | III      | 20    |         |            |          |     |             |              |        |
|                           | 122 mm     | <b>SPEED C50-12</b>  | GU5,3             | III      | 20    |         |            |          |     |             |              | p. 94  |
|                           | 122 mm     | <b>SPEED C50-230</b> | GU10              | II       | 20    |         |            |          |     |             |              |        |
|                           | 134 mm     | <b>HIDRO</b>         | GU5,3             | II / III | 20/65 | Vol. 1  |            |          |     |             |              | p. 83  |
|                           | 134 mm     | <b>HIDRO</b>         | GU10              | II       | 20/65 | Vol. 2  |            |          |     |             |              | p. 82  |
| 73 mm                     | 29 mm      | <b>AQUAFLAT</b>      | LED               | II       | 20/65 | Vol. 2  |            |          |     |             |              | p. 72  |
|                           | 55 mm      | <b>AQUAPRO</b>       | LED               | II       | 20/65 | Vol. 2  |            |          |     |             |              | p. 73  |
|                           | 81 mm      | <b>EF7</b>           | LED               | I        | 20/65 | H. Vol. |            |          |     |             |              | p. 70  |
|                           | 81 mm      | <b>EF7 CCT</b>       | LED               | I        | 20/65 | H. Vol. |            |          |     |             |              |        |
|                           | 123 mm     | <b>LUNAR 230</b>     | GU10              | II       | 20    |         |            |          |     |             |              | p. 103 |
|                           | 125 mm     | <b>LUNAR 12</b>      | GU5,3             | III      | 20    |         |            |          |     |             |              | p. 102 |
| 75 mm                     | 24 mm      | <b>ASPEN</b>         | LED               | II       | 20/44 | Vol. 2  |            |          |     |             |              | p. 81  |
|                           | 50 mm      | <b>HIDRO 50 XL6</b>  | LED XL6           | II       | 20/65 | Vol. 1  |            |          |     |             |              | p. 77  |
|                           | 66 mm      | <b>RANDY S</b>       | LED               | II       | 20    |         |            |          |     |             |              | p. 58  |
|                           | 76 mm      | <b>IVARO 7,5W</b>    | LED               | II       | 20/44 | Vol. 1  |            |          |     |             |              | p. 49  |
|                           | 84 mm      | <b>ELITE F4 IP44</b> | LED               | II       | 20/44 | Vol. 2  |            |          |     |             |              | p. 89  |
|                           | 95 mm      | <b>GALAXY</b>        | GU10              | II       | 20    |         |            |          |     |             |              | p. 100 |
|                           | 108 mm     | <b>DLT-ISO 75</b>    | GU10              | I        | 20    |         |            |          |     |             |              | p. 66  |
|                           | 130 mm     | <b>CLASSO</b>        | GU5,3             | II / III | 20/44 | Vol. 1  |            |          |     |             |              | p. 80  |
| 80 mm                     | 130 mm     | <b>EN 63</b>         | E27               | II       | 20    |         |            |          |     |             |              | p. 108 |
| 82 x 82 mm                | 133 mm     | <b>SPEED C70 12</b>  | GU5,3             | III      | 20    |         |            |          |     |             |              | p. 95  |
|                           | 133 mm     | <b>SPEED C70 230</b> | GU10              | II       | 20    |         |            |          |     |             |              |        |
| 82 mm                     | 125 mm     | <b>SPEED R70 12</b>  | GU5,3             | III      | 20    |         |            |          |     |             |              |        |
|                           | 125 mm     | <b>SPEED R70 230</b> | GU10              | II       | 20    |         |            |          |     |             |              |        |
| 83-95 mm                  | 67 mm      | <b>ELODY 10W</b>     | LED               | II       | 20    |         |            |          |     |             |              | p. 86  |
| 83 x 70 mm                | 139 mm     | <b>TOP 0</b>         | GU5,3             | III      | 20    |         |            |          |     |             |              | p. 107 |
| 84 mm                     | 44 mm      | <b>DL 084</b>        | LED               | II       | 20/44 | Vol. 2  |            |          |     |             |              | p. 77  |
| 85 mm                     | 95 mm      | <b>DL-ISO IP20</b>   | LED               | II       | 20    |         |            |          |     |             |              | p. 67  |
| 90 mm                     | 41 mm      | <b>P10</b>           | LED               | II       | 20/65 | Vol. 2  |            |          |     |             |              | p. 76  |
|                           | 60 mm      | <b>LEDIUM 10W</b>    | LED               | II       | 20/44 | Vol. 2  |            |          |     |             |              | p. 46  |
|                           | 65 mm      | <b>BIRDY</b>         | LED               | II       | 40/44 | Vol. 2  |            |          |     |             |              | p. 50  |
|                           | 86 mm      | <b>ELITE A5</b>      | LED               | II       | 20    |         |            |          |     |             |              | p. 88  |
|                           | 90 mm      | <b>DLT-ISO 90</b>    | GU10              | I        | 20    |         |            |          |     |             |              | p. 66  |
| 90-95 mm                  | 61 mm      | <b>LOKI 8W</b>       | LED               | II       | 20/44 | Vol. 2  |            |          |     |             |              | p. 75  |
| 91 mm                     | 107 mm     | <b>SPEED 90</b>      | GU10              | II       | 20    |         |            |          |     |             |              | p. 96  |
| 94 x 94 mm                | 126 mm     | <b>SQUARE 50</b>     | GU10              | II       | 20    |         |            |          |     |             |              | p. 106 |
| 94 x 192 mm               | 126 mm     | <b>SQUARE 110</b>    | GU10              | II       | 20    |         |            |          |     |             |              |        |
| 90-102 mm                 | 66 mm      | <b>RIVA 10W</b>      | LED               | II       | 20    |         |            |          |     |             |              | p. 52  |

## DÉCOUPES - ENCASTRÉS DE PLAFOND

| Dimensions d'encastrement | Profondeur | GAMME | Type de luminaire | Classe | IP | Volume | Orientable | Dimmable | CCT | Recouvrable | BBC / RT2012 | Page |
|---------------------------|------------|-------|-------------------|--------|----|--------|------------|----------|-----|-------------|--------------|------|
|---------------------------|------------|-------|-------------------|--------|----|--------|------------|----------|-----|-------------|--------------|------|

### Downlights - Encastrement supérieur à 100 mm

|              |        |                   |       |     |       |        |  |  |  |  |  |        |
|--------------|--------|-------------------|-------|-----|-------|--------|--|--|--|--|--|--------|
| 100 mm       | 88 mm  | RANDY 1           | LED   | II  | 20    |        |  |  |  |  |  | p. 58  |
|              | 92 mm  | IVARO 13W         | LED   | II  | 20/44 | Vol. 2 |  |  |  |  |  | p. 49  |
| 100-110 mm   | 37 mm  | START CCT 120     | LED   | II  | 20/54 | Vol. 2 |  |  |  |  |  | p. 53  |
| 100 x 100 mm | 181 mm | QUADRA 110        | GU5,3 | III | 20    |        |  |  |  |  |  | p. 107 |
| 100 x 192 mm | 181 mm | QUADRA 110-2      | GU5,3 | III | 20    |        |  |  |  |  |  |        |
| 113 mm       | 107 mm | SPEED 110         | GU5,3 | III | 20    |        |  |  |  |  |  | p. 96  |
| 125 mm       | 127 mm | IVARO 34W         | LED   | II  | 20/44 | Vol. 2 |  |  |  |  |  | p. 49  |
| 130 mm       | 75 mm  | GRACE 12W         | LED   | II  | 20/44 | Vol. 2 |  |  |  |  |  | p. 51  |
| 150 mm       | 79 mm  | GRACE 17W         | LED   | II  | 20/44 | Vol. 2 |  |  |  |  |  |        |
|              | 138 mm | RANDY 2           | LED   | II  | 20    |        |  |  |  |  |  | p. 58  |
| 150-160 mm   | 37 mm  | START CCT 170     | LED   | II  | 20/54 | Vol. 2 |  |  |  |  |  | p. 53  |
| 160 mm       | 35 mm  | FLAT-ISO CCT 13W  | LED   | II  | 20/65 | Vol. 2 |  |  |  |  |  | p. 47  |
|              | 60 mm  | LEDIUM 15W        | LED   | II  | 20/44 | Vol. 2 |  |  |  |  |  | p. 46  |
| 160 x 160 mm | 190 mm | QUADRA LED MONO   | LED   | II  | 20    |        |  |  |  |  |  | p. 62  |
| 160 x 295 mm | 190 mm | QUADRA LED DUO    | LED   | II  | 20    |        |  |  |  |  |  |        |
| 160 x 435 mm | 190 mm | QUADRA LED TERTIO | LED   | II  | 20    |        |  |  |  |  |  |        |
| 168 mm       | 20 mm  | FLAT LED 13W      | LED   | II  | 20    |        |  |  |  |  |  | p. 54  |
|              | 22 mm  | FLAT CCT 12W      | LED   | II  | 20    |        |  |  |  |  |  | p. 55  |
| 175 mm       | 165 mm | RANDY 3 / 4       | LED   | II  | 20    |        |  |  |  |  |  | p. 59  |
| 180 mm       | 132 mm | FORTISSIMO        | LED   | II  | 20    |        |  |  |  |  |  | p. 52  |
| 195-210 mm   | 118 mm | RIVA 28W          | LED   | II  | 20    |        |  |  |  |  |  |        |
| 200-220 mm   | 37 mm  | START CCT 230     | LED   | II  | 20/54 | Vol. 2 |  |  |  |  |  | p. 53  |
| 200-220 mm   | 100 mm | HARDEN 14-20-28W  | LED   | II  | 20/54 | Vol. 2 |  |  |  |  |  | p. 48  |
| 210 mm       | 35 mm  | FLAT-ISO CCT 20W  | LED   | II  | 20/65 | Vol. 2 |  |  |  |  |  | p. 47  |
|              | 60 mm  | LEDIUM 20-25-30W  | LED   | II  | 20/44 | Vol. 2 |  |  |  |  |  | p. 46  |
| 225 mm       | 20 mm  | FLAT LED 20W      | LED   | II  | 20    |        |  |  |  |  |  | p. 54  |
|              | 22 mm  | FLAT CCT 20W      | LED   | II  | 20    |        |  |  |  |  |  | p. 55  |
| 228 x 134 mm | 127 mm | METROPOLIS 30W    | LED   | II  | 20    |        |  |  |  |  |  | p. 61  |
|              | 145 mm | METROPOLIS 45W    | LED   | II  | 20    |        |  |  |  |  |  |        |
| 284 mm       | 20 mm  | FLAT LED 30W      | LED   | II  | 20    |        |  |  |  |  |  | p. 54  |
| 302 x 302 mm | 190 mm | QUADRA LED QUATRO | LED   | II  | 20    |        |  |  |  |  |  | p. 62  |

### Dalles LED

|               |       |                       |     |    |    |  |  |  |  |  |  |       |
|---------------|-------|-----------------------|-----|----|----|--|--|--|--|--|--|-------|
| 595 x 595 mm  | 9 mm  | DALLE LED PREMIUM     | LED | II | 20 |  |  |  |  |  |  | p. 43 |
| 596 x 595 mm  | 31 mm | DALLE LED BKL PREMIUM | LED | II | 20 |  |  |  |  |  |  | p. 44 |
| 596 x 595 mm  | 31 mm | DALLE LED BKL         | LED | II | 20 |  |  |  |  |  |  | p. 45 |
| 300 x 1200 mm | 31 mm | DALLE LED BKL PREMIUM | LED | II | 20 |  |  |  |  |  |  | p. 44 |